



The Exmoor



Exmoor Gas Stove
For Natural Gas and LPG

INSTALLATION, SERVICING AND USER INSTRUCTIONS

This product is for use only in Great Britain and Ireland (GB, IE)

These instructions are to be left with the customer, should be read carefully and kept in a safe place.

They will be necessary when servicing the appliance.

IMPORTANT

**THIS APPLIANCE MUST ONLY BE OPENED, INSTALLED AND SERVICED BY A
CORGI REGISTERED ENGINEER**

PM165 Issue 1 (October 2005)

Contents

USERS INSTRUCTIONS

Welcome to Yeoman	2
Commissioning Data	3
Guarantee	3
Safety Notes	4
Operating the Stove	4
Remote Control (Manual Operation)	5
Twin Rotary Control with Optional Remote	6
Timer Remote Control	7
Ventilation	8
Arranging the Layout of the Coals	8
Procedure for Arrangement	8

INSTALLATION INSTRUCTIONS

Technical Specifications

List of Component Parts for Exmoor	10
Gas Stove	
Dimensions of Stove	10
Technical Information	10
Safety Notes	10

Site Requirements

Flue Requirements	11
Flue Connection	11
Ventilation	11
Locating the Appliance	11

Installation

Gas Connection	12
Arranging the Layout of the Coals	12
Procedure for Arrangement	12
Operating the Stove	13
Fitting the Optional Canopy	13
Remote Control	13

Commissioning

Completing the Installation	14
Appliance Testing	14
Commissioning The Stove	14
Post Installation Checks	14

Servicing and Fault Finding

Servicing Instructions	15
Trouble Shooting	15
Short Spares List	16
Service Record	17



Welcome to Yeoman

Your new Exmoor gas stove is perhaps the most advanced design of modern stoves. Owning such a stove shows appreciation for exceptional quality.

Please read your manual thoroughly, it's purpose is to familiarise you with your stove, and give guidelines for it's installation, operation and maintenance. If after reading this manual you need further information, please do not hesitate to contact your supplier.

IMPORTANT NOTICE

If your stove is installed correctly, it will give you many years of excellent service for which it was designed. This appliance must be installed by a qualified installer, we recommend that you have a C.O.R.G.I registered engineer to install your stove for you.

WARNING

All types of heating appliance can be potentially dangerous. Correct installation and operating procedures must be observed when fitting this stove. Some parts of your stove are protected on their surface with heat proof paint. When the stove is first used it is normal for it to emit some light smoke, with an unpleasant smell. Though unpleasant, this is non toxic and is produced only whilst the stove paint fully cures. We recommend that you ventilate the room until this disappears.

The fuel effect components in this stove are made from Refractory Ceramic Fibre. Please refer to service instructions on page 15 for safe handling and removal.

USERS INSTRUCTIONS

3. SAFETY NOTES

The Exmoor gas stove is designed to be used with either Natural Gas or LPG, however each individual appliance is only capable of using the gas specified on the data plate. It is important to note that once a gas type has been specified, the stove cannot be used with any other gas. The type of gas the stove is capable of burning is stated on the data plate located on the front of the stove, by the control knob, check that the appliance has been correctly supplied.

Installation of your Yeoman Stove must comply with current Building Regulations, therefore should be installed by a CORGI engineer. The engineer will provide you with information about the safety limits of the installation and should fix a notice plate in a place where it can be readily seen, eg: next to the electricity meter.

This appliance must never be operated with the doors open or removed, or if the glass is broken. This appliance is designed as an efficient heating device and consequently all body parts of the stove become very hot in use. Except for the control knob and control access door, which are designed to stay cool, all other parts are working surfaces and should not be touched.

The glass and door on this appliance acts as a fireguard conforming to BS:1945 – 1971 and satisfies the Heating Appliance (Fireguards) Regulations 1991. No part of the glass or door should be permanently removed. It does not give full protection for young children or the infirm, extra protection conforming to BS 6539 or BS 6778 should be considered for these conditions.

Bearing in mind that the heat given off by this appliance may affect articles placed close to it, curtains should not be placed within 300mm.

The appliance is not designed as a dryer. It is not therefore recommended that the appliance be used in such a manner. Do not place any articles within 300mm of the stove as this may result in damage to the articles.

4. OPERATING THE STOVE

IT IS VERY IMPORTANT TO READ THESE INSTRUCTIONS THOROUGHLY BEFORE LIGHTING THE STOVE.

The stove will produce an odour and/or smoke for the first few hours of use when new. Please ventilate the room when first lighting from new.

The appliance incorporates an ODS (Oxygen Depletion Sensor) in the pilot assembly on the burner which is non-adjustable.

Its purpose is to monitor the air condition of the room and cut off the gas to the appliance before the air condition in the room reached any harmful levels/

The ODS must only be replaced with genuine Yeoman parts.

The controls for the stove are located behind the access door positioned under the front of the stove. To access, open the door by pulling from the right hand side.

The Exmoor operates with a permanent pilot light. The pilot light is located in the centre of the burner, and is visible through a cut-out in the ceramic matrix. If the Flame Supervision Device Actuating Flame (the Pilot Light) is extinguished either by intention or not, no attempt should be made to re-light until 3 minutes have elapsed.

Important: Immediately after lighting, the stove must be left on HIGH for ten minutes in order to warm up the flue.

4.1 REMOTE CONTROL (MANUAL OPERATION)

a) Igniting the Pilot Light

1. Turn the Left hand knob slightly anti-clockwise towards the ignition position until reaching stop, depress and hold for five seconds (only pilot gas flows). See Fig. 1.
2. Whilst still depressed, turn further in a anti-clockwise direction to activate the piezo. If the pilot does not light, steps 1 and 2 can be repeated immediately.
3. Continue to keep the knob depressed for a further 10 seconds, after the pilot has been lit.
4. Upon releasing the knob, the permanent pilot will remain lit, if not return to 1.

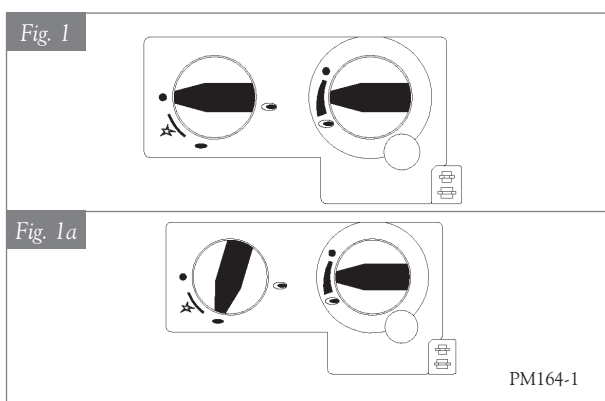

b) Running the stove at high output

1. Ignite permanent pilot as shown in Fig.1a.
2. Turn the left-hand control knob anti-clockwise to the setting, which shows the larger flame. See Fig. 2.
3. Turn the right-hand control knob anti-clockwise to the highest setting (large flame).
4. The stove is now burning at it's highest operating output.

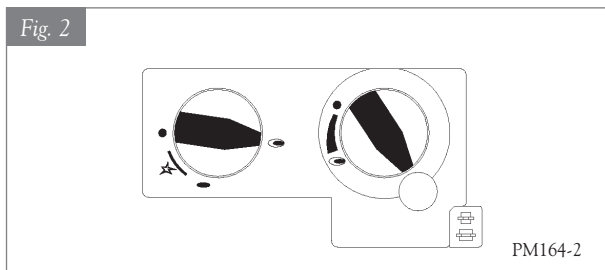

c) Running the stove at low setting

1. Ignite permanent pilot and run stove at "HIGH" setting for a minimum of 10 minutes as shown in Fig. 2.

2. With the right-hand control knob at the highest setting , rotate in a clock-wise direction to the lowest setting (filled circle). See Fig. 3.

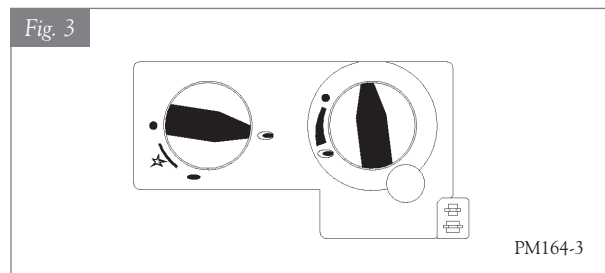

d) Extinguishing the stove back to permanent pilot setting

1. From any heat setting, turn the left-hand knob in a clockwise direction to the "PILOT" position (a smaller flame is shown). See Fig. 4

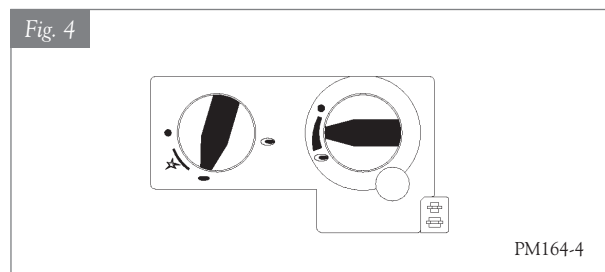

e) Extinguishing the stove fully

1. From any heat setting, turn to "PILOT" as in Fig 4.
2. Depress the same knob slightly and turn clockwise to "OFF" position (filled circle). See Fig. 5.

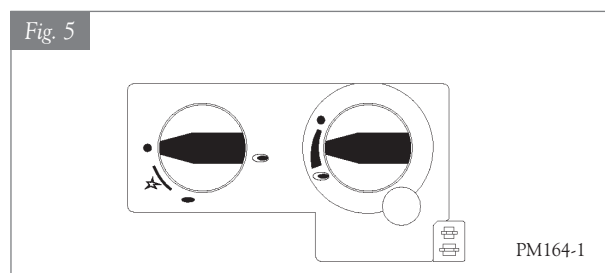

5. TWIN ROTARY CONTROL with OPTIONAL REMOTE

Light the pilot as described in section 4.1a. Turn left hand control anti-clockwise until it is on the large flame setting. You are now able to use the remote control. To increase the flame, the top button should be pressed. Pressing the lower button on the handset will reduce the flame. It is also possible to turn the main burner all the way down so that it is effectively off, leaving only the pilot ignited. See Fig. 5.

5.1 TIMER REMOTE CONTROL

TRANSMITTER FUNCTION



SET THE DISPLAY

After connecting the battery or by simultaneously pressing AUTO and TIMER, the display flashes. You are in set mode.

From set mode, press AUTO to switch from Degrees F (and 12 hour clock) to Degrees C (and 24 hour clock) or vice versa.

The display will automatically return to manual mode after some time, but you may immediately return to manual by depressing the TIMER button.

SET THE CURRENT TIME.

After connecting the battery or by simultaneously pressing AUTO and TIMER, the display flashes. You are in set mode.

From set mode, press ▲ to set the hour and ▼ set the minute.

Wait or press TIMER to return to “manual” mode.

PROGRAMMING THE DESIRED SET TEMPERATURE

Press AUTO until the display flashes.

Press ▲ or ▼ to set the desired temperature.

Wait or press AUTO to switch to automatic mode.

A sensor in the transmitter measures room temperature. The controller compares the room temperature with the set temperature and sends a signal to the receiver to turn the gas valve motor, which adjusts the flame height accordingly.

PROGRAMMING THE TIMER

Press TIMER until P1* flashes (period 1, heating cycle on).

Set the time for the beginning of the first heating period by pressing ▲ for hour and ▼ for minute.

Press TIMER again; P1) appears.

Set the time for the end of the first heating period.)

Press TIMER again to set the second heating period

P2* heat on and P2 (heat off)

Store both heating periods by pressing TIMER again.

If only one period is desired, program the same time for P2* and P 2.)

MANUAL MODE (MAN IN DISPLAY) FOR MANUAL FLAME HEIGHT ADJUSTMENT.

Press ▲ to turn on the fire (main burner) or to increase flame height.

Press ▼ to decrease flame or to turn down to pilot.

To incrementally increase or decrease the flame height lightly tap either the ▲ or ▼ button.

The “send” symbol appears in the upper left corner of the display when either button is depressed.

The LED of the receiver flashes when the larger knob of the valve reaches its end stops.

AUTOMATIC MODE (AUTO IN DISPLAY) FOR TEMPERATURE CONTROL

Briefly press AUTO. The set temperature will appear briefly before the display reverts to the room temperature.

TIMER MODE (TIMER IN DISPLAY)

During heating periods P1* and P2*, the temperature is controlled in the same manner as in automatic mode. When the timer programme turns to) (heating cycle off), the motor will turn the valve to the pilot and there is no temperature control. This minimises battery consumption.

You may press AUTO to verify the set-temperature and then press TIMER to return to timer mode

You may press either the ▲ or ▼ button from any mode for manual override.

To prolong battery life, we recommend switching the transmitter to manual mode and turning the fire to pilot with the ▼ button before turning the appliance off. If the transmitter is left in automatic or timer mode, the batteries will continue to be used when the appliance is off.

CHANGING THE BATTERY

If BATT appears in upper right hand corner of the display or if the LED of the receiver becomes faint, please change the battery from the transmitter or receiver. If the batteries lose power, the flame height can be adjusted by manually turning the larger knob.

USERS INSTRUCTIONS

NOTE

Please note, the placement of the transmitter (temperature sensor) is important to assure proper temperature regulation. Generally, a more constant temperature will be assured, if the transmitter is not too far from the gas appliance.

Before switching to AUTO or TIMER mode, press either button ▲ or ▼ to verify reception (when the send symbol appears in the transmitter display, the receiver's LED must illuminate) For the AUTO or TIMER mode to function correctly, the transmitter must remain within range of the receiver. The transmitter should not be used in very close proximity to the receiver (less than 1m/3ft) as this could, in very rare cases, produce a electronic switching error. This error could block the motor when the larger knob reaches the end points of its turning radius. The knob must then be turned manually to free the blockage.

The temperature is controlled by activating the motor for a specific length of time to adjust the appropriate flame height. This time is calculated by the transmitter and depends on variables such as room size, heater capacity, battery power etc. Therefore, a few cycles are necessary before an optimum is achieved. If a low flame is sufficient to provide enough warmth to the room, then the appliance will cycle between low fire and off. This allows longer periods with the flame on and provides a more uniform room temperature.

It is recommended to turn the combination control either to the off or pilot position if the appliance is left unattended for longer periods (eg. Holidays), so that it cannot receive commands from the remote transmitter. Exercise caution when leaving the appliance unattended, in exceptional cases sound waves from sources other than the transmitter can cause changes in flame height adjustment.

6. VENTILATION

The Exmoor gas stove is rated at less than 7kW; it therefore does not normally require additional ventilation in the room to conform to BS 5871 pt.2. However it is important that adequate air for complete combustion is available. If other gas appliances or extractor fans are fitted in the same room or adjacent rooms. Refer to BS 6714 and BS 5440 pt.2. to ascertain the additional ventilation requirements.

7. ARRANGING THE LAYOUT OF THE COALS

Only the ceramic coals supplied with this appliance are to be used. The coals must be laid only as detailed in this manual. Replacement coals, ceramic and mat are available from your dealer.

The stove should arrive with the following parts as required for the coal layout:

1 No.	Ceramic Mat
1 No.	Matrix
6 No.	Medium Coals
5 No.	Small Coals (Nat.Gas only)

See Fig. 11 to identify components, However please note that the Matrix changes dependent on Gas type.

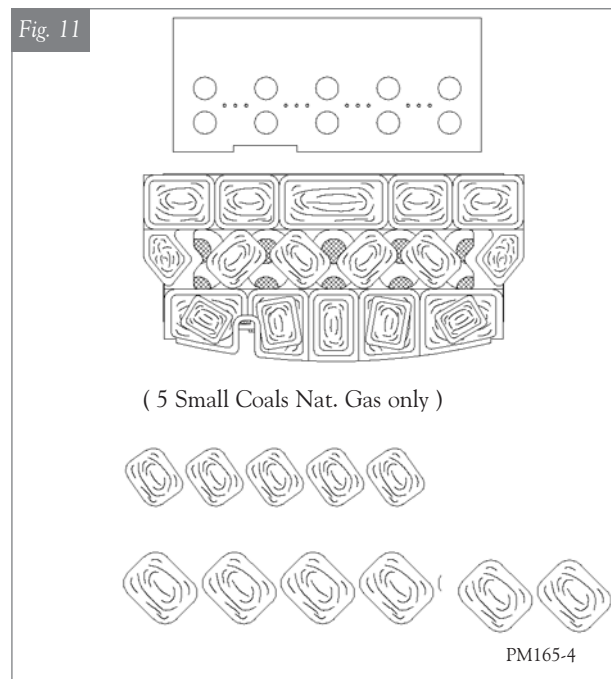

Natural Matrix - 95mm high

LPG Matrix - 65mm high

Please check that the correct parts and quantities have been delivered before commencing installation.

USERS INSTRUCTIONS

8. PROCEDURE FOR ARRANGEMENT

Ensure that the Pilot Assembly remains unobstructed when arranging the coals. Note that there is a viewing slot in the matrix so that the Pilot Flame will be visible when lit, this must also be kept clear.

Please note that once the stove is lit, the coals become very hot, care must be taken when adjusting coals after the appliance has been lit and Yeoman Stoves accept no responsibility for any injury sustained whilst handling hot ceramics.

STAGE 1

Lay the Ceramic Mat on top of the Burner as shown in Fig. 12 making sure that all holes including the 12 small cross lighting holes are not blocked, and that the pilot assembly is not obstructed.

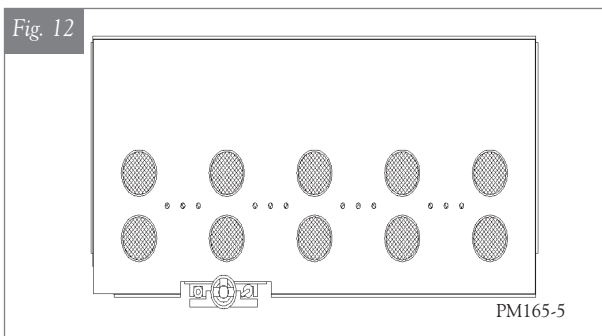

STAGE 2

Place the Ceramic Matrix on top of the mat and burner as shown in Fig. 13.

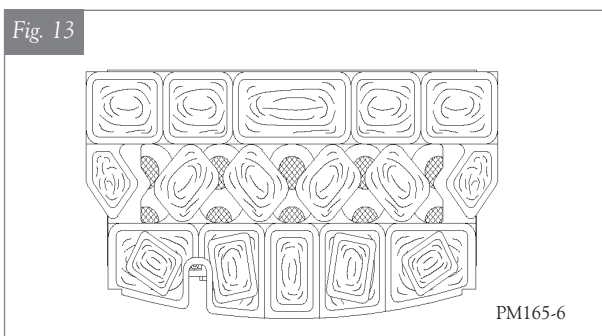

STAGE 3

Place the 6 Medium Ceramic Coals on the back of the Matrix as shown in Fig. 14.

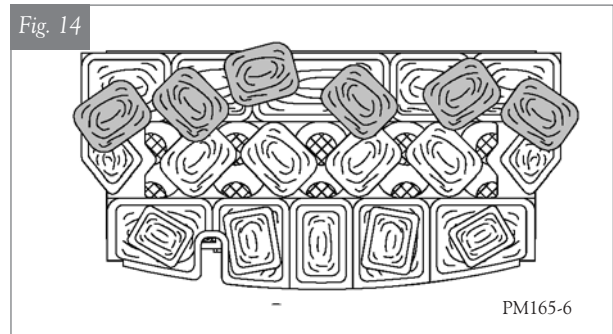

STAGE 4 (NATURAL GAS ONLY)

Place the 5 Small Ceramic Coals around the front of the matrix as shown in Fig. 15

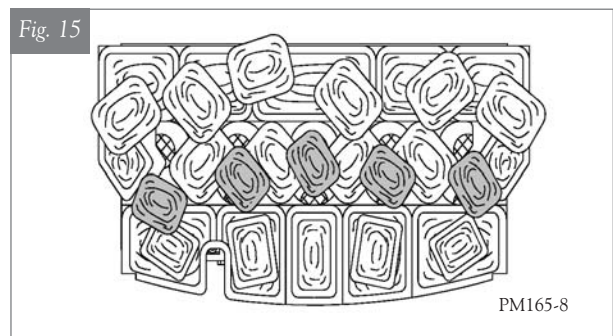

INSTALLATION INSTRUCTIONS - TECHNICAL SPECIFICATIONS

1. LIST OF COMPONENT PARTS FOR EXMOOR GAS STOVE.

1 No.	Stove body complete
1 No.	Ceramic Matrix*
1 No.	Ceramic Mat
1 No.	Bag of Coals
1 No.	Flue Kit Comprising of:
1 No.	125mm Bolt on Flue Connector
1 No.	Flue Blanking Plate
2 No.	Flue Gaskets
6 No.	M6 x 20 Set Screws
3 No.	M6 Washers
1 No.	Flat Top Flue Blank
1 No.	Instruction Manual

*Note; NG Matrix = 95 mm high
LPG Matrix = 65 mm high

2. DIMENSIONS OF STOVE.

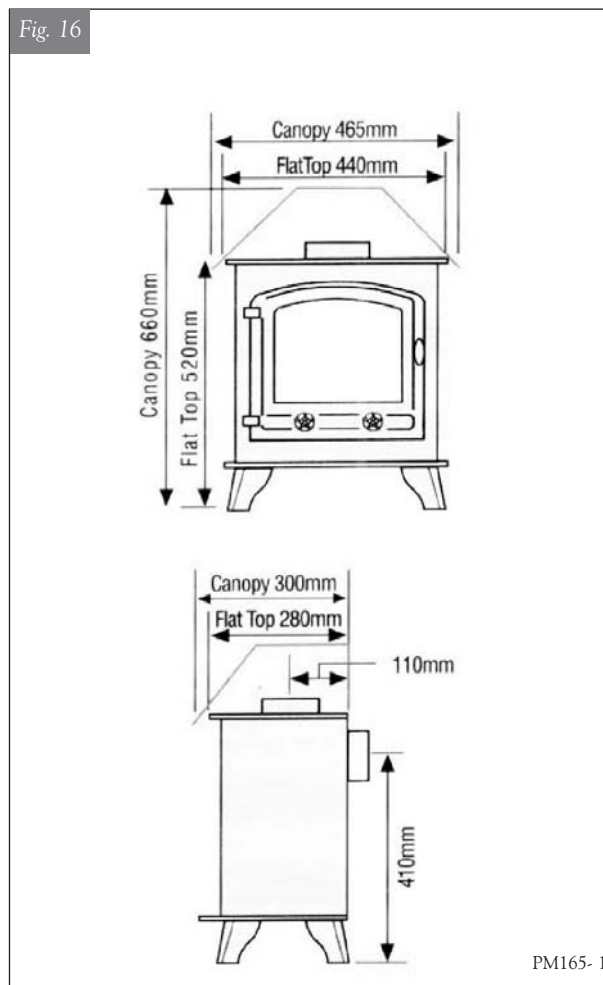

3. TECHNICAL INFORMATION

Inlet pipe connection:	8mm compression.
Chimney requirements:	Class I or Class II
Flue fitting:	125mm diameter Top or Rear Outlet.
Stove control:	Front mounted variable rotary gas Control With Integrated Piezo Ignition, Permanent Pilot Facility, Flame Failure Device and Flue Monitor. OR as above with Remote Control Option.
Battery type (Remote version)	Receiver - 4x AA (Alkaline only) Transmitter - (Alkaline only), 1 x PP3.
Flue Monitor:	Oxygen Depletion Sensor (ODS).
NOx level:	Class 5 (i.e. below 100 mg/kWh).

	N.GAS	LPG
HEAT INPUT	5.4 kW	4.8kW
SUPPLY PRESSURE	20mbar	37mbar
GAS RATE	0.51 m ³ /h	0.18m ³ /h

4. SAFETY NOTES

This appliance incorporates an ODS (Oxygen Depletion Sensor) on the pilot assembly on the burner, which is non adjustable. The ODS shall not be adjusted by the installer, or put out of operation.

Its purpose is to monitor the air condition in the room and cut off the gas to the appliance before the air condition in the room reaches any harmful levels.

The ODS or any of its parts must only be replaced with genuine Yeoman parts.

INSTALLATION INSTRUCTIONS - SITE REQUIREMENTS

1. FLUE REQUIREMENTS

The flue which the appliance is to be attached must conform to BS 5440 2000:pt.1. Before the appliance is installed, the flue system or chimney must be tested and passed as suitable.

This stove is suitable for installation onto either a flexible or fabricated steel flue system and is also suitable for class 1 and pre-cast flues, pre-cast chimney block, pre-cast flue block and ridge tile vent. The minimum effective height of the flue must be three metres measured from the hearth to the termination of the flue. If the flue has any non-vertical sections, the height should be increased in line with BS 5440 pt.1 Prior to installation, the installer should ensure that the flue is free from obstruction, ideally should be swept and subsequently smoke tested. Ensure that any dampers are fixed in a permanently open position. The appliance has been designed with a built in draught diverter, and as such no further draught diverter need be fitted to the flue system.

NOTE: If it is intended to fit the stove into an existing brick built chimney without a closure plate, a 5" (127mm) liner must be used. Larger lined flues may work, but in some instances could cause cold start flue problems resulting in nuisance shutdown. Lined flues above 7" (175mm) are not recommended.

PRIOR TO INSTALLATION A SMOKE TEST MUST BE CARRIED OUT TO ASCERTAIN THAT THERE IS SUFFICIENT DRAUGHT IN THE FLUE FOR SAFE OPERATION OF THE STOVE.

2. FLUE CONNECTION

The Exmoor stove may be installed as either top or rear flue, and as such comes with all relevant parts to enable connection of flue to either flue system.

If the appliance is to be installed with a Top Flue, place 1 of the gaskets on the top flue position. Using 3 set screws and washers attach the flue connector and tighten up to ensure that the gasket is fully sealing and is airtight. Repeat this operation on the back plate with the flue blanking plate (with 3 holes drilled) and 3 set screws; once again ensuring that the gasket enforces a good seal and is air tight. This will leave the Flat Top Flue Blank (no holes); this part is redundant and may be disposed of.

If the stove is to be fitted as rear flue the same procedure as above should be followed but with the Bolt on Flue Connector and Flue Blanking Plate reversed. If fitted as Rear Flue then the Flat Top Flue Blank will sit on top of the screws holding the Flue Blanking plate and will then sit flush with the Top plate.

It is recommended that a minimum height of 610mm from the stove should be established before any significant changes in direction of the flue. Horizontal or

negative gradients in the flue pipe should be avoided.

The flue system may now be connected to the stove; this should be sealed using a fire resistant sealant. Please note that all flue systems should be installed in accordance with the flue manufactures recommendations and BS5871 :pt.1.

When installing the flue in properties of timber framed construction, the regulations (BS 5440 : pt1 : 2000 must be adhered to.

3. VENTILATION

The Exmoor gas stove is rated at less than 7kW; it therefore does not normally require additional ventilation in the room to conform to BS 5871 pt.2. However it is important that adequate air for complete combustion is available, and also if other gas appliances or extractor fans are fitted in the same room or adjacent rooms. Refer to BS 6714 and BS 5440 :pt.2. to ascertain the additional ventilation requirements.

4. LOCATING THE APPLIANCE

The appliance must stand on a fireproof hearth, which must be of a non-combustible material with a minimum thickness of 12mm and must extend to at least the lip of the stove.

The appliance must have a minimum clearance of 75mm between the rear of the draught diverter and any wall/closure plate etc. The appliance must not be fitted against a rear wall constructed from a combustible material; a minimum gap of 280mm should be given all round the stove before combustible materials may be used in the wall construction.

If the appliance has to be located in an opening, there must be a minimum of 150mm each side of the appliance and 75mm to the rear measured from the rear edge of the draft diverter.

A combustible shelf may be fitted over the appliance, if in the case of a 150mm or less deep shelf, there is at least 280mm clearance above the top of the stove. The shelf depth may increase at the same rate as the increase in clearance; i.e. a shelf depth of 200mm would require a clearance of 330mm.

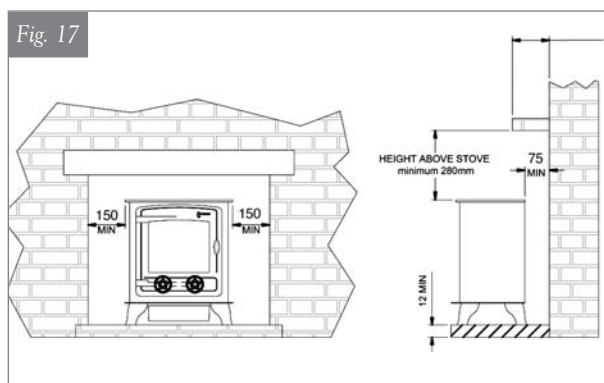

INSTALLATION INSTRUCTIONS - INSTALLATION

1. GAS CONNECTION

Before installation, ensure that the local distribution conditions (identification of the type of gas and supply pressure) and the adjustment of the appliance are compatible.

It is important to ensure that all pipe work installed is fitted in accordance with BS6891 and is capable of supplying sufficient gas flow and pressure to meet the minimum pressures quoted on page 14 of this manual. A minimum pipe size of 15 mm should be used for the gas supply to within 1 metre of the appliance. 8 mm pipe may only be used for the final connection to the stove, or within 1 metre of the appliance. An 8 mm nut and olive is supplied with the stove for the final pipe joint. A length of formed pipe and a test point elbow (with isolation valve) is supplied with the stove, please fit as desired and check soundness before final positioning of the appliance.

Do not make any connections to the appliance until all supply pipes have been purged to expel any dust or debris. Failure to do this may result in a blocked injector or tap and will invalidate the guarantee.

Although a gas soundness test is made on all appliances before they leave the factory, the appliance must be tested for soundness before operating the stove. This is to ensure that the burner has not been damaged in transit.

The Exmoor gas stove is designed to be used with either Natural Gas or LPG, however each individual appliance is only capable of using the gas specified at the time of purchase. It is important to note that once a gas type has been specified, the stove cannot be used with any other gas. The type of gas the stove is capable of burning is stated on the data plate located on the front of the stove, by the control knob, check that the appliance has been correctly supplied.

2. ARRANGING THE LAYOUT OF THE COALS

Only the ceramic coals supplied with this appliance are to be used. The coals must be laid only as shown on the following pages. Replacement coals, ceramic and mat are available from your dealer, but should only be installed by a CORGI registered engineer.

The stove should arrive with the following parts as required for the coal layout:

1 No.	Ceramic Mat
1 No.	Matrix
6 No.	Medium Coals
5 No.	Small Coals (Nat.Gas only)

See Fig. 11 to identify components, However please note that the Matrix changes dependent on Gas type.

Fig. 11

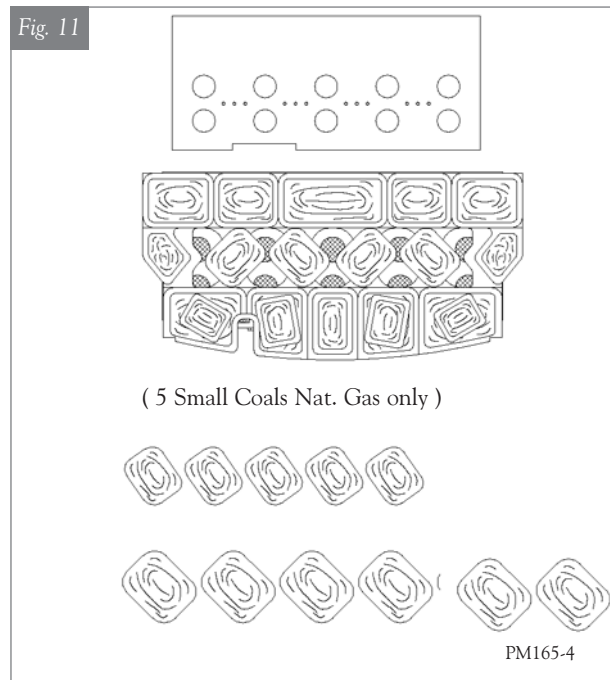

Natural Matrix - 95mm high

LPG Matrix - 65mm high

Please check that the correct parts and quantities have been delivered before commencing installation.

3. PROCEDURE FOR ARRANGEMENT

Ensure that the Pilot Assembly remains unobstructed when arranging the coals.

Note that there is a viewing slot in the matrix so that the Pilot Flame will be visible when lit, this must also be kept clear.

Please note that once the stove is lit, the coals become very hot, care must be taken when adjusting coals after the appliance has been lit and Yeoman Stoves accept no responsibility for any injury sustained whilst handling hot ceramics.

STAGE 1

Lay the Ceramic Mat on top of the Burner as shown in Fig. 12 making sure that all holes including the 12 small cross lighting holes are not blocked, and that the pilot assembly is not obstructed.

Fig. 12

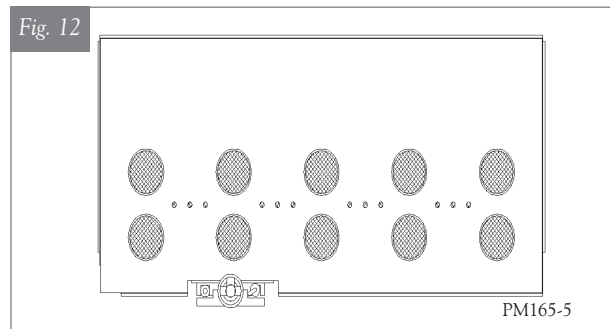

INSTALLATION INSTRUCTIONS - INSTALLATION

STAGE 2

Place the Ceramic Matrix on top of the mat and burner as shown in Fig. 13.

Fig. 13

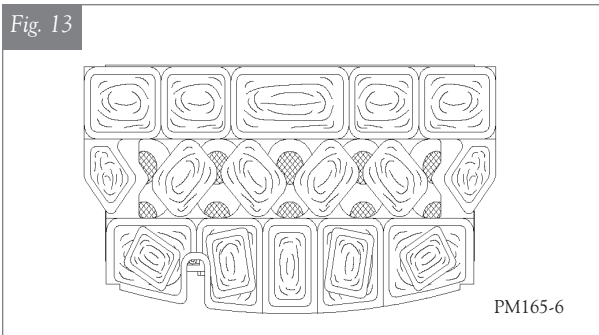

STAGE 3

Place the 6 Medium Ceramic Coals on the back of the Matrix as shown in Fig. 14.

Fig. 14

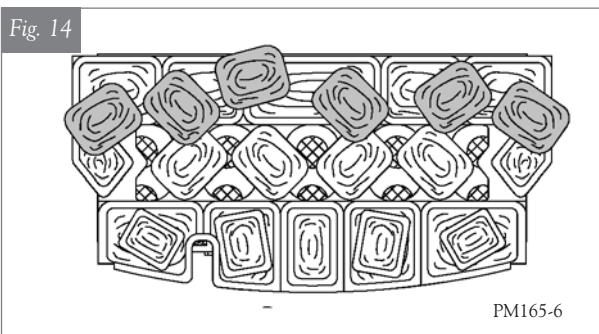

STAGE 4 NATURAL GAS ONLY

Place the 5 Small Ceramic Coals around the front of the matrix as shown in Fig. 15.

Fig. 15

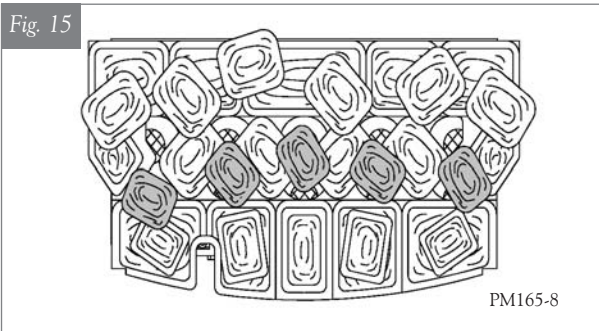

4. OPERATING THE STOVE

SEE USERS SECTION

5. FITTING THE OPTIONAL CANOPY

All Exmoor gas stoves are supplied as Flat tops; an additional canopy is available which can be used to change the appearance of the appliance. Although this is an additional canopy it is still a working surface and will get very hot when the stove is being operated.

When fitting the canopy, all the flue connections will remain connected to the flat top flue spigot. The canopy will then sit on top of the flat top and (if top flue) will slide around the flue pipe. Depending if the stove is top or rear flue the appropriate blank will be used to fill in the gap.

6. REMOTE CONTROL

Refer to the installation instructions supplied with the remote control unit for fitting of the motor and receiver. This requires no external power to operate. The receiver unit can be hidden under or behind the appliance, ensuring that the receiver is located in an area that has a temperature below 60°C and that the customer knows where the receiver is for future battery replacement.

INSTALLATION INSTRUCTIONS - COMMISSIONING

1. COMPLETING THE INSTALLATION

THE APPLIANCE MUST NEVER BE OPERATED WITH THE DOOR REMOVED OR GLASS BROKEN.

When the coals and matrices have been arranged as shown on page 12 above, the door must be closed and a good seal achieved.

The door is closed by tightening the supplied washer and nut. Finally, the cast knob should be screwed onto the same bolt as the nut. This can then be tightened up with orientation either horizontal or vertical, noting that it is not necessary to “wrench” this knob on tight. Ensure that the rope seal is forming a good seal around the door in all places.

2. APPLIANCE TESTING

The gas pressure to the appliance must be measured; this should be measured with all gas appliances with the gas meter operating on full, including the Exmoor stove. It should be 20mb +/-5%. The flow rate should be checked using the method described in the CORGI Essential Gas Safety book. See Technical Specification section 3. +/-5%. cm³/hr as in section 2 +/-5%

The above values are on “HIGH” and should be measured whilst all appliances are on full.

3. COMMISSIONING THE STOVE

A spillage test **MUST** be made before the installed fire is left with the customer. Carry out the test by first closing all doors and windows in the room containing the stove.

Ensure that the fire is burning at full rate for a minimum of 5 minutes to warm the flue. Using a smoke match - run along the edge of a draught diverter as shown in Fig.22. below. The smoke should be drawn into the draught diverter. The test should be made over the full width of the draught diverter, and the test may be done from either left to right.

Fig.22 - Spillage test (shown as rear flue, top flue draught diverter identical)

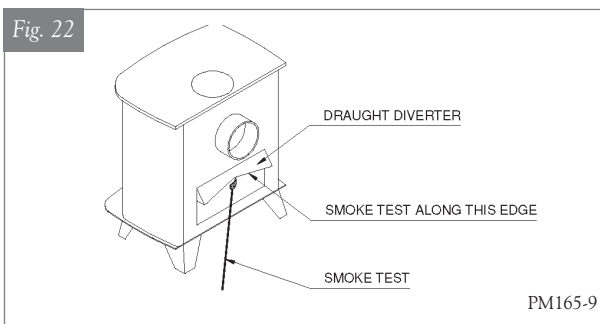

If most of the smoke is not drawn into the draught diverter leave for a further 10 minutes and repeat.

If there is a fan in the room (or adjacent rooms) the spillage test must be repeated with the fan running on full power and all connecting doors between the fire and fan left open.

If there are problems, the chimney/flue may require attention. Isolate the stove and seek expert advice.

The stove will produce an odour and/or smoke for the first few hours of use. Please ventilate the room.

4. POST INSTALLATION CHECKS

BEFORE LEAVING THE APPLIANCE CONNECTED TO THE GAS SUPPLY, THE INSTALLER IS REQUIRED TO VISUALLY EXAMINE THE APPLIANCE AND FLUE WAY TO ENSURE THAT:

- The seal between the combustion chamber and the room is intact and in good condition.
- The flue has been correctly sealed.
- There is no debris contained within the flue assembly.
- All pipe work must be purged.

PLEASE EXPLAIN TO THE CUSTOMER THE LIGHTING AND EXTINGUISHING PROCEDURES.

INSTALLATION INSTRUCTIONS - SERVICING AND FAULT FINDING

ADVICE ON HANDLING AND DISPOSAL OF FIRE CERAMICS

The fuel effect matrix and coals in this appliance are made from Refractory Ceramic Fibre (RCF), a material which is commonly used for this application.

Protective clothing is not required when handling these articles, but we recommend you follow normal hygiene rules of not smoking, eating or drinking in the work area and always wash your hands before eating or drinking.

To ensure that the release of RCF fibres are kept to a minimum, during installation and servicing a HEPA filtered vacuum is recommended to remove any dust accumulated in and around the appliance before and after working on it. When servicing the appliance it is recommended that the replaced items are not broken up, but are sealed within heavy duty polythene bags labelled as RCF waste.

RCF waste is classed as stable, non-reactive hazardous waste and may be disposed of at a licensed landfill site.

Excessive exposure to these materials may cause temporary irritation to the eyes, skin and respiratory tract; wash hands thoroughly after handling the material.

1. SERVICING INSTRUCTIONS

The following outlines only the minimum work that should be performed on an annual basis. This service work, like any other work on the appliance, must only be done by a qualified and competent engineer who is registered with C.O.R.G.I.

- a) Open the door. This is achieved by first un-screwing the cast handle to reveal an M6 nut, un-screw the nut, and door will open.
- b) Remove all coals and matrix from top of burner.
- c) Remove ceramic mat from top of burner and discard.
- d) Remove any debris from the top of the burner using a vacuum cleaner and brush.
- e) Inspect the burner unit.
- f) Perform an ignition check.
- g) Perform a flame failure check.
- h) There should be no need to service the burner. If however this is required, then the engineer should check the setting pressure at inlet to burner; the correct pressure is shown on the data information plate.
- i) **Place new ceramic mat in position.** Brush off and replace coal arrangement as shown on pages 12-13, replacing any damaged pieces.
- j) Check all seals on door (including glass) and close the Door.
- k) Check the installation for gas leaks.
- l) Check flue for clearance of products of combustion. If any parts need to be replaced use only genuine Yeoman parts, non-standard parts will invalidate the guarantee and may be dangerous.

2. TROUBLE SHOOTING

A) The gas pilot will not ignite or stay lit?

- i) Ensure the gas is turned on at the appliance and the meter/cylinder.
- ii) Depress the control knob for at least twenty seconds once the pilot is alight to ensure the operation of the safety thermocouple valve.
- iii) Ensure that the pilot injector is not obstructed or blocked and it is free from any dust or dirt.
- iv) Ensure that the thermocouple has not been damaged in transit. This is a very delicate Electro-magnetic device.
- v) On propane, the cylinder could be empty.

B) The pilot is not burning or performing correctly?

- i) Ensure the pilot flame is the correct size for the type of gas. The flame should be focused on the thermocouple probe.
- ii) The pilot flame will have been set correctly in the factory.

C) The Main Burner does not seem to be burning correctly?

- i) Ensure adequate gas pressure to the appliance. The pressure can be checked by unscrewing the pressure test nipple and applying a suitable pressure gauge (i.e. a manometer). Ensure adequate volume of gas is being used. Once the fire is burning on maximum, turn off all other gas appliances in the house and calculate the fuel being burned from the gas meter.
- ii) Make sure that the burner is burning correctly. The flame should be even across the top of the burner before any coals are placed on top.

D) Optional Remote Control will not function.

- i) Check PP3 battery in the handset is fully charged, if not, change battery. Check the four AA batteries in the receiver box are fully charged, if not, replace them.

3. SHORT SPARES LIST

Only original Yeoman parts may be used when replacing parts on this appliance.

Exmoor/Exmouth NG Matrix set	YM-YG76142
Exmoor/Exmouth LPG Matrix set	YM-YG76342
Exmoor/Exmouth Ceramic Mat	YM-YG76131
Mertik Gas Tap NG	YM-YG75308
Mertik Gas Tap LPG	YM-YG75309
Exmoor NG Injector	YM-YG60077
Exmoor LPG Injector	YM-YG60177
ODS Nat Gas Pilot assembly	YM-YG80282
ODS LPG Pilot assembly	YM-YG80982
Exmoor Electrode	YM-YG14082
Ignition Lead	YM-YGC0090
Remote Motor Unit	YM-EL0234
Exmouth Glass 262.4x228.5mm curved 630R	GL0242

SERVICE RECORDS

1ST SERVICE

Date of Service:

Next Service Due:

Signed:

Dealer's Stamp/CORGI Registration Number

2ND SERVICE

Date of Service:

Next Service Due:

Signed:

Dealer's Stamp/CORGI Registration Number

3RD SERVICE

Date of Service:

Next Service Due:

Signed:

Dealer's Stamp/CORGI Registration Number

4TH SERVICE

Date of Service:

Next Service Due:

Signed:

Dealer's Stamp/CORGI Registration Number

5TH SERVICE

Date of Service:

Next Service Due:

Signed:

Dealer's Stamp/CORGI Registration Number

6TH SERVICE

Date of Service:

Next Service Due:

Signed:

Dealer's Stamp/CORGI Registration Number

7TH SERVICE

Date of Service:

Next Service Due:

Signed:

Dealer's Stamp/CORGI Registration Number

8TH SERVICE

Date of Service:

Next Service Due:

Signed:

Dealer's Stamp/CORGI Registration Number

9TH SERVICE

Date of Service:

Next Service Due:

Signed:

Dealer's Stamp/CORGI Registration Number

10TH SERVICE

Date of Service:

Next Service Due:

Signed:

Dealer's Stamp/CORGI Registration Number

NOTES

NOTES

YEOMAN STOVES

A division of Stovax Ltd

Falcon Road, Sowton Industrial Estate, Exeter, EX2 7LF

Tel 01392 474500 Fax 01392 219932

www.yeoman-stoves.co.uk

Email: yeoman@stovax.com