



icast range



F2 FIRES

Vue (Landscape)

5kW (Nom 8kW) Multi Fuel
Free Standing

Installation and operating manual



PAUL AGNEW | DESIGNS

English



Vue (Landscape)

5kW (N. 8kW) Multi Fuel
Free Standing

PAUL AGNEW | DESIGNS



Introduction and safety

| | |
|---|---|
| Safety - Installation | 4 |
| Safety - Ventilation | 4 |
| Safety - Clean air act 1993 and smoke control areas | 5 |

Before you start

| | |
|-------------------------|---|
| Before you start | 6 |
| Item check list | 7 |
| Safety check list | 7 |
| Considerations | 8 |

Installation and testing

| | |
|-------------------------------|---|
| Adjusting the handle | 8 |
| Fitting and connections | 9 |
| Testing | 9 |

Operation

| | |
|---------------------------------------|----|
| Lighting | 10 |
| How to light and sustain a fire | 11 |
| Types of fuel | 12 |

Maintenance

| | |
|-------------------|----|
| Maintenance | 13 |
|-------------------|----|

Operational issues

| | |
|---------------------------|----|
| Problem solving | 14 |
| Running temperature | 15 |

Specifications

| | |
|----------------------------|----|
| Dimensions | 16 |
| Operating parameters | 16 |
| Warranty card | 17 |
| Installer notes | 19 |

INTRODUCTION AND SAFETY

F2 Fires Limited and Paul Agnew Designs have created this stove to exceed our customers' expectations. Functionality, design and high quality are the main priorities for our entire range of superior appliances and related products. It is our extensive experience and knowledge that ensures your home will be warm and cosy for many years to come. Sitting in the light and warmth of the fire, you will understand that we simply **Create Atmosphere**.

This manual is for the **5kW Vue Landscape Stove**, which is designed to be used as a Freestanding stove. Throughout this manual, we will refer to this model as the 'appliance'. To further appreciate your new appliance please read the following carefully:

This appliance is designed, tested and manufactured as a closed stove for burning wood to BSEN13240 standard, smokeless fuel and anthracite. F2 Fires recommends that this appliance is installed by a HETAS registered installation engineer or a competent person only and failure to comply will invalidate your warranty.

Safety - Installation

Installation of your appliance must comply with all local building regulations, including those referring to UK National and European Standards. We advise prior to any installation that a full site survey is conducted by a qualified installation engineer, recognised within an industry standard such as NACS or HETAS, to check the suitability of your chimney and appliance beforehand.

Within the UK, **Document J** of the Building Regulations contains further information regarding the installation of solid fuel appliances. This can be viewed by searching for '**Planning Approved Document J**' online at www.gov.uk within the United Kingdom. You should also check the relevant planning and building regulations in your own country and your local area, as they may differ from UK National regulations.

Safety - Ventilation

In order for smoke to be drawn up the chimney, the correct amount of ventilation is required. A chimney requires air movement to work correctly, which is not possible if there is an inadequate source of air. Prior to installation, you should ensure that your appliance has the correct conditions in order to operate as intended.

Other heating appliances that also require air for combustion should not be used in the same room as this appliance, unless adequate additional ventilation is provided.

For combustion and the evacuation of dangerous flue gases, this appliance requires a supply of air. Without adequate air supply, the appliance will not operate correctly and smoke may escape back out into your house.

Any air inlet grilles should be positioned so that they are not liable to becoming blocked. Ongoing maintenance of the air inlet systems is essential to ensure the continued safe operation of this appliance.

An air extraction device should not be used in the same room as this appliance, unless adequate additional ventilation is provided. Extractor fans when operating in the same room or space as the appliance may cause problems with the extraction of dangerous flue gases.

We recommend that you discuss your ventilation and installation requirements with your local F2 Fires authorised retailer if you have any doubts or queries.

Images within this manual will not necessarily be exactly as the model referenced, and may be subject to change.

Clean air act 1993 and smoke control areas

Under the Clean Air Act, local authorities may declare the whole or part of the district of the authority to be a **Smoke Control Area**. It is an offence to emit smoke from a chimney of a building, from a furnace or from any fixed boiler, if located in a designated smoke control area. It is also an offence to acquire an “unauthorised fuel” for use within a smoke control area unless it is used in an “exempt” appliance (“exempted” from the controls which generally apply in the smoke control area).

In England, appliances are exempted by publication on a list by the Secretary of State in accordance with changes made to sections 20 and 21 of the Clean Air Act 1993 by section 15 of the Deregulation Act 2015. In Scotland appliances are exempted by publication on a list by Scottish Ministers under section 50 of the Regulatory Reform (Scotland) Act 2014. Similarly, in Northern Ireland appliances are exempted by publication on a list by the Department of Agriculture, Environment and Rural Affairs under Section 16 of the Environmental Better regulation Act (Northern Ireland) 2016. In Wales appliances are exempted by regulations made by Welsh Ministers. Further information on the requirements of the Clean Air Act can be found by searching for '**Smoke control area rules**' online at www.gov.uk within the United Kingdom.

Your local authority is responsible for implementing the Clean Air Act 1993 including designation and supervision of smoke control areas and you can contact them for details of Clean Air Act requirements.

Our appliance - the 8kW Tuscany multifuel stove, has been recommended as suitable for use in smoke control areas when burning wood logs. All appliances have been fitted with a modified air control to prevent closure of the secondary air control beyond 6mm (30%) open.

Please note the following guidance :

Refuelling on to a low fire bed

If there is insufficient burning material in the firebed to light a new fuel charge, excessive smoke emission can occur. Refuelling must be carried out onto a sufficient quantity of glowing embers and ash that the new fuel charge will ignite in a reasonable period. If there are too few embers in the fire bed, add suitable kindling to prevent excessive smoke.

Fuel overloading

The maximum amount of fuel specified in this manual should not be exceeded, overloading can cause excess smoke.

Operation with door left open

Operation with the door open can cause excess smoke. The appliance must not be operated with the appliance door left open except as directed in the instructions.

Dampers left open

Operation with the air controls or appliance dampers open can cause excess smoke. The appliance must not be operated with air controls, appliance dampers or door left open except as directed in the instructions.

BEFORE YOU START

1.

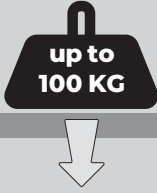

First, check the load bearing capacity of your floor

Before installing the appliance, you must ensure that the load bearing capacity of the floor is equal to the weight of the appliance, as well as any flue pipes and connections. The weight of the appliance is 84kg approximately when empty. Remember to also account for the additional weight once the appliance contains the internal components and fuel.

2.

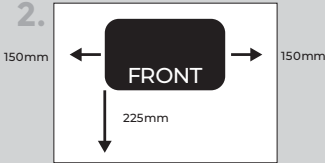

Ensure the suitability of your hearth

The appliance should be installed on a minimum 12mm thick, non-combustible hearth. The hearth should extend to a minimum distance of 225mm in front of the appliance and 150mm to each side, measured from the door of the combustion chamber. Please refer to **document J** of the building regulations for further information on hearth requirements.

3.

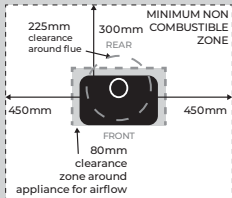

Check clearance to combustibles

The minimum clearance to combustible materials is 450mm on both sides of the appliance, 300mm to the rear of the appliance. A minimum of 80mm clearance should be left at the back and sides of the appliance to allow free air movement and for heat to enter the room. There should be a minimum clearance around the 5" flue pipe of 225mm radius above the appliance.

4.

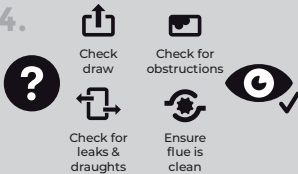

Inspect your chimney

An existing chimney or a new flue installation should be given a visual inspection to check that it is in good order, clear of obstructions and is of a suitable size and type for the appliance. It is essential to first sweep the flue before fitting the appliance or lining a chimney.

5.



Inspect your airflow

In order for smoke to be drawn up the chimney, ventilation into the room is required. Normally, sufficient air will come into a room naturally, however in some modern passive homes, there may be a need for additional ventilation. A chimney requires air movement to work, which may not be possible if there is an inadequate source of air. Prior to installation, you should ensure you have the correct conditions in order to operate this appliance which is 550mm² free air.

Item check list



Cast Stove Body

The appliance is a single unit and is very heavy. See *Lifting warnings* below.

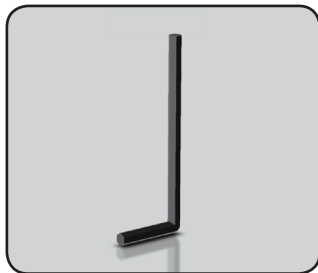

Allen Key

For making door adjustments if necessary.

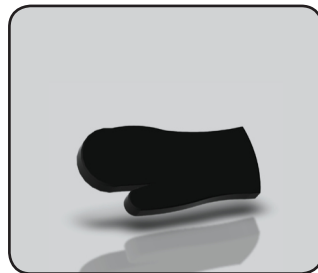

Glove

For ensuring safe operation of the handle when the appliance is hot.

Safety check list



TAKE CARE WHEN LIFTING - 89kg

This product weighs 89kg. Take necessary precautions and care when lifting and handling this appliance. A minimum of two competent people will be required to lift and manipulate this appliance into position. Firstly, ensure the area is clear and free from obstructions. Check the appliance is secure and stable when moving and that you are wearing adequate safety gear.



ENSURE YOU HAVE AN APPROVED CARBON MONOXIDE ALARM FITTED

An approved carbon monoxide alarm with a 7-year life sealed or replaceable battery must be installed before any Solid Fuel appliance is installed. Carbon monoxide alarms need to meet European safety standards and **must be audible**. They must be fitted in accordance with the manufacturer's instructions. Please Note: Regular maintenance and chimney sweeping is still essential.

The appliance must not be modified in any way. Any changes will invalidate your warranty and may damage the appliance or cause an unforeseen safety issue. Any replacement parts that you may require over the lifetime of the appliance must be official F2 Fires appliance parts ONLY.

Considerations

Test the chimney thoroughly

We recommend that a smoke test is carried out to check for gas tightness within your flue and for chimney draughts. Lining and insulating your chimney before installation is highly recommended. Ensure there is adequate access to the chimney to allow for sweeping on a regular basis.

Consider additional ventilation

We strongly recommend that you consider ventilation requirements before installation of your appliance. If your appliance smokes or does not burn very keenly, but improves noticeably when you open a window, this is a sign that you need to install additional ventilation. See *Ventilation - Introduction and Safety* section for more information.

Suitability

Make sure that the area in which the appliance is to be fitted is suitable for this appliance. Walls adjacent to the appliance should be of a suitable non-combustible construction material, preferably brick, as this appliance can reach external temperatures of up to and above 300°C. Check adequate precautions are taken to prevent touching hot appliances. Always use adequate heat proof protection, such as the supplied glove, when operating the metal handle as it will become hot during use and for some time afterwards.

Air Damper

It is recommended that chimneys with a strong updraught be fitted with a flue damper or draught stabiliser to allow the chimney draught to regulate properly. No damper should close the flueway completely - not less than 20% of the total chimney or flue pipe should remain open at all times.

INSTALLATION AND TESTING

Adjusting the handle



Adjustment points on the appliance

The door handle has a sophisticated adjustment system, however, it comprises of only 4 parts and can be adjusted very simply from the outside. Over time, the door rope will flatten and the seal may start to let uncontrolled air into the appliance. This may allow unwanted air into the combustion box and could increase the speed of the burn. This will affect the controllability of the appliance and at this point, you should adjust the handle;

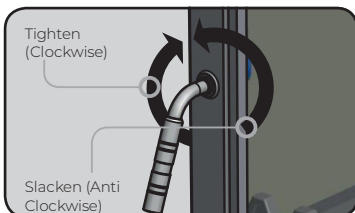

Insert the supplied Allen key into the hole in the side of the door containing the set-screw. Turn it anti-clockwise to slacken the set-screw until the door handle becomes loose. Once loose, turn the handle the correct way as shown in the drawing to the left. On completion, slowly re-tighten the set-screw until the handle is set properly and the door shuts tightly again.

Fitting and connections

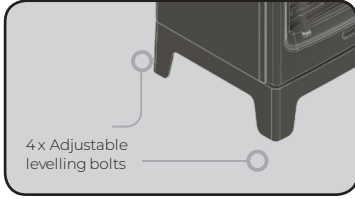

Adjustment points on the appliance

This is a free standing appliance designed to be suitable for 12mm hearths. Once the flue is in position, the appliance should be secure. However if the floor surface is uneven, additional fixings are supplied to allow the adjustment of the four feet. Always ensure the appliance is level and secure after adjustments are made.

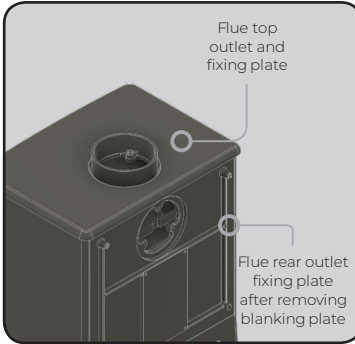

Flue connections

This appliance has a **top** and **rear** outlet. The top outlet is the most common for flue connections. The rear outlet has the same connections but the blanking plate will need to be removed first before it can be used. The minimum flue draught required for nominal heat output is 12 Pascals.

At nominal heat output, the flue gas temperature will be in the region of 242°C. The appliance should never be connected to a shared flue. Seal the flue connections with fire cement or a high temperature rope seal. The flue blanking plate should be positioned over whichever outlet is not being used.

A register plate (not supplied) may be required to seal off the throat of the fireplace and has a hole for a flue pipe. It also provides access for sweeping and, if required, has a connection for a bracket to support the flue. A 5" (127mm) flue pipe is required from the appliance to the register plate. Consult your installation engineer if you require one.

Testing



Testing points

This appliance has a flue test point which has various functions:

- Helping to ensure correct installation and aiding the installer to set up the Tuscany with the flue-pull in order to match the manufacturer's recommendations. See *Safety - Ventilation*.
- For measuring the flue-pull during servicing to check for soot or tar buildup in the chimney.

The test point is situated discreetly at the top right hand side of the appliance. The M8 screw can be removed and a flue test meter can be placed in the hole in order to measure the flue-pull. On completion, always ensure the M8 screw is re-fitted.

Lighting

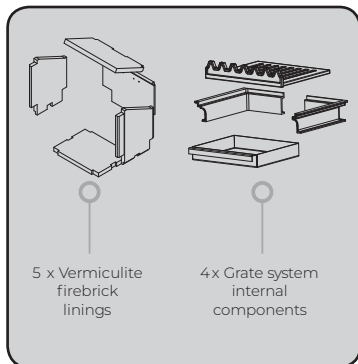

Before lighting the appliance

Before lighting the appliance for the first time, please ensure all firebrick linings and other internal components are in position and that all packaging has been removed.

When lighting your appliance for the first time, it should not be stoked excessively as the materials must be given time to adapt to the effects of heat. Your appliance has been painted with specialist High Temperature paint and oven cured during the manufacturing process. However upon initial lighting of the appliance, further curing may occur and a slight smell may be evident. We recommend that windows and doors are left open during this time, which will allow the smell to dissipate.



Step 1 Place rolled up crumpled paper at the back of the appliance. Next, place a small amount of tinder/kindling on top of the paper followed by a few larger pieces of wood. Light the paper and close the door. NEVER USE FLAMMABLE LIQUIDS

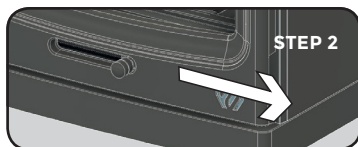

Step 2 Open the front air control (Primary air) fully, using the glove provided.

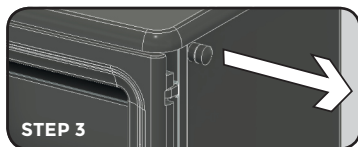

Step 3 Allow the fire to burn until all the pieces of wood are alight and burning. The side air intake (Secondary air) can be used if additional air is needed. More larger pieces of fuel can now be added. Be careful not to add so much fuel that it is in danger of overflowing the fuel bar or touching the glass.

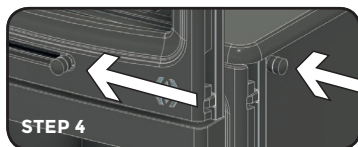

Step 4 Once the fire is established, both air controls can be reduced in order to maintain a steady burn rate dependant on your fuel type.

REMEMBER:

You should never run the appliance with the door open.

HOT SURFACES DURING OPERATION



All parts of the appliance will become hot during use. Always use the glove provided to operate any element on the appliance, especially the air control and the door handle. Once lit, ensure that adequate precautions are taken to ensure that others, including children, pets and combustibles cannot come into contact with any of the appliance's hot surfaces.

How to light and sustain a fire

First stage

The fire is usually smokiest just after lighting due to the coldness of the wood and appliance, which can take heat away from the flames. During this stage, ensure that the primary air inlet is fully open to increase the flame temperature and initial heat. Heat will escape straight into the flue system, however, this is a necessary part of starting an efficient fire. The inbuilt tertiary air supply inside the appliance is non-adjustable. Using the primary and secondary inlets allows you to increase air above and beyond what the inbuilt tertiary air system supplies.

Initial heat

The additional heat at the first stage will prime the chimney, producing a strong draught. It will also help to keep the chimney or flue clean by loosening anything deposited during a previous fire. The hot initial burn also drives moisture from the firewood and gives an ignition source for the smoke that is released from the wood.

Adding fuel

When adding fuel, only make small, gradual changes. Do not add too much fuel at once. Adding fuel gradually will help to maintain a steady optimum temperature and burning rate so that the appliance burns efficiently and cleanly. Adding too much fuel will also dramatically reduce the temperature inside the firebox. After adding large pieces of fuel, it is recommended that you increase the air opening slightly so that the new fuel begins to burn and the appliance returns to optimum operational temperature.

This also applies to the air control. Adjusting it gradually will help maintain a steady combustion rate. In most instances, you will arrive at the best combustion air settings yourself, as the height and diameter of the chimney, as well as the quality of the fuel used are decisive factors in determining your appliance's efficiency.

Small hot fires are more efficient than large slumbering ones. Most of the energy in burning wood is released as a bright flame. The turbulence in the flames creates good mixing between the combustion air and the gases that are released from the wood as it heats up. The heat of the fire ignites and burns these gases. In contrast, the dense smoke from a slow, smoldering fire is potential heat energy that can escape up the chimney and either cling to the chimney flue or pollute the atmosphere with unburnt carbons.

To gain the most heat from each burn, the fuel should be flaming throughout the burn cycle until it is reduced to ash. Should any regular slow-burning occur, it is always good practice to burn a hot fire at regular intervals to keep the chimney clean and dry. When refueling, always place the fuel towards the back of the appliance where it will burn at a higher temperature.

The removal of ashes

The ashes should only be removed when the fire is out and has been left to cool completely. The log retaining bar can be removed for easier access by lifting it up. Wood burns well on a thin layer of ash and leaving this behind when cleaning will provide protection for the base and insulating bricks, thus prolonging their life.

NEVER attempt to remove the ashes when the stove is hot or warm. DO NOT attempt to remove ashes directly after use. Allow the stove and ashes to cool down fully before attempting any maintenance. Ashes can remain hot even when they appear to be no longer lit. Please ensure you use the correct tools to dispose of them safely, and if you are unsure, allow them to cool further before attempting to remove them.

Types of fuel

Wood

Wood needs to be well seasoned before it is burnt. For the best performance, you should use kiln dried wood or seasoned wood with no more than 20% moisture content. As a general guide, wood should be cut to length, split and then stacked under cover outside with the sides open to the air, for at least 12 months. You can tell that wood is ready for burning when radial cracks appear at the end of the logs.

It is then good practice to store the wood in a log basket inside your property for a few days prior to its use. The internal width of the firebox of the Tuscany is 395mm, therefore firewood should be no longer than this and a little shorter to aid refueling. Logs over 100mm diameter should be split before use.

Smokeless Fuel

There are several types of smokeless fuel, we recommend only smokeless coal, coke or briquettes that are HETAS approved and authorised for use in smokeless zones. Smokeless fuels can give over 30% more heat and last over 30% longer than traditional house coals, whilst at the same time emitting upto 80% less smoke and 25% less Carbon Dioxide, making it much kinder to the environment.

Smokeless fuels have an excellent heat output and a very long fire life, that easily lasts through the night. Smokeless fuels are not difficult to light and produce little ash.

Anthracite

Anthracite is a natural hard, shiny form of coal that is naturally smokeless. Although anthracite can take longer to light, it can burn for very long periods producing a large amount of heat per volume. It can be a higher price-per-bag than other fuels, but anthracite can work out to be one of the more cost effective fuels long term.

We recommend the small-nut size. Smaller anthracite nuts pack together tighter to create a more intense and long lasting fire bed which is popular with those looking for efficient heat. Anthracite is a high performance fuel which burns with a high heat and low flame, and leaves little ash behind. Suitable for burning in smoke control areas.

Restrictions

- **DO NOT burn unseasoned wood in your appliance.**
- **DO NOT burn particle board, lacquered, painted or treated wood, plastics, rubber or liquid fuels.**
- **DO NOT use starter fluids or liquid fuels to start a fire**
- **DO NOT burn waste. This appliance should not be used as an incinerator.**

Should the fire be used to burn any of the restricted materials mentioned above, it will not only invalidate your warranty but may damage the appliance or cause an unforeseen safety issue.

MAINTENANCE

Any maintenance of the appliance should only be carried out when the appliance is **COLD**. Daily maintenance should be limited to vacuum cleaning the appliance externally or brushing down with a soft brush. Never use spirits to clean the appliance as this may damage the paint surface. Regularly check the flue exit from the appliance to make sure there is no buildup of deposits that may restrict the exit of the flue gases.

Chimney sweeping

The chimney should be swept a minimum of once per year. This must be carried out by a registered and competent person. If the appliance is used more regularly, the chimney should be swept accordingly. Your appliance should also be given a visual inspection every time the chimney is swept.

These checks should include the rope seals, door handle, firebricks and baffle. Any buildup of soot and ashes within the appliance should be removed, the cause determined and rectified.

Fire bricks

The fire bricks are manufactured from vermiculite. Vermiculite is a non-combustible fire resistant board, with excellent thermal insulation properties and is safe to handle. As vermiculite is a porous material, it may over time become worn or damaged. Please handle with care, especially when re-fueling the appliance. The insulation only needs replacing once it has deteriorated to an extent that it is no longer protecting the body of the appliance from the flames. Cracks in the vermiculite are normal and will not interfere with the efficiency of the appliance.

The vermiculite insulation is not covered by the manufacturer's warranty and may need replacing over time.

Door glass

Blackening of the door glass is usually a result of burning damp wood (See *Problem solving - Blackened glass*). The longer staining is left to build up on the glass, the harder it becomes to clean it off. We recommend wiping the glass after each fire to prevent any buildup of deposits over time.

This is best done using a paper towel or newspaper to avoid scratching the glass. Using a piece of newspaper to wipe the inside of the window glass before lighting the appliance each time will also help to prevent the gradual buildup of deposits and make future cleaning much easier. For more stubborn stains, a suitable stove glass cleaner will be available from your authorised F2 Fires dealer.

Glass is not covered by the manufacturer's warranty and may need replacing if it becomes damaged.

Surface

The high temperature paint finish should require no further treatment. However, any damage or wear on small areas of the paint finish may be remedied by using our high temperature aerosol paints. We recommend Calfire Stove Bright® paints, as other paints may not be suitable to such high temperatures and substrates. Please read the instructions on the aerosol carefully before applying and ensure the appliance is completely cold.

NEVER attempt any kind of maintenance when the stove is hot or warm. DO NOT attempt to clean the glass directly after use. Allow the stove to cool down fully before attempting any maintenance or cleaning.

Problem solving

| Problem | Possible causes and solutions |
|--|---|
| <p>Blackened glass</p> | <ul style="list-style-type: none"> ● The wood is too damp. Only use wood that has been stored for at least 12 months under cover and ideally with a moisture content of less than 20%. (See <i>How to light and sustain a fire - Types of fuel</i>) ● Insufficient intake of air from the air control. Open the air controls further to determine the correct balance for your fuel type. (See <i>Operation - Lighting</i>) ● Insufficient ventilation. The appliance is being run at too low a temperature. (See <i>Operation - Lighting, Operational issues - Running temperature, Safety - Ventilation</i>) |
| <p>Smoke in the room when refueling</p> | <ul style="list-style-type: none"> ● Poor chimney performance. Consult a chimney sweep or your installation engineer. ● Check the position of any fitted flue damper to make sure it is in the 'open' position. ● Never open the door when there are high flames on the fuel. Wait until the fuel is burning low before refueling. |
| <p>Uncontrollable combustion</p> | <ul style="list-style-type: none"> ● If there is excessive chimney draught, you may need to fit a draught stabiliser in the flue pipe. Consult a chimney sweep or your installation engineer. ● Door not closed tightly, Adjust the set-screw on the handle. (See <i>Installation and testing - Adjusting the handle</i>) ● Damaged door seal. Consult your installation engineer or approved dealer about fitting a new rope seal. |

Running temperature

Thermometers are available that attach to the flue pipe directly above the appliance and aid in running the appliance at the correct temperature. Your installation engineer should advise you of the correct settings after installation and testing is complete, by using this test procedure.

150°C-300°C

Perfect. The flue gases should be within this temperature range for the safest and most efficient operation of your appliance.

Below 150°C

Too low. This will cause the condensation of wood gases and the buildup of tar in the chimney. It can also dirty the glass with excess soot and results in the inefficient burning of fuel.

Above 300°C

Too hot. Heat will be wasted up the chimney. Excess heat may damage the appliance over time or ignite the existing accumulation of tar, which can result in a chimney fire (See *Warning* below).

Overheating

Should the appliance be allowed to get too hot and overheat, you should close the Primary and Secondary air controls fully, using the glove provided. Keep the fire door closed and allow the fire to burn down and the temperature to drop before allowing air back in gradually (See *Above 300 °C* above).

Chimney Fire



In the event of a chimney fire, always **dial 999** and ask for the **Fire Service**. If safe to do so, fully close all air controls and keep the appliance door closed. Move any combustibles away from the appliance and chimney. Check any other rooms that the chimney passes through and move any combustibles away from the chimney breast. Before using the appliance again after a chimney fire, the chimney should be thoroughly cleaned and inspected by a qualified person to ensure further damage has not occurred.

SPECIFICATIONS

Dimensions

| | |
|----------------------|--|
| Width | 430mm |
| Height | 570mm |
| Depth | 394mm |
| Firebox width | 395mm ??? |
| Weight | <ul style="list-style-type: none">• Appliance 84kg• Packaging 5kg• Combined 89kg |

OFFSET

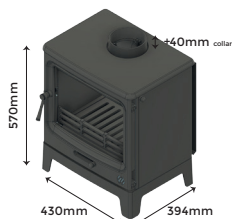

TOP

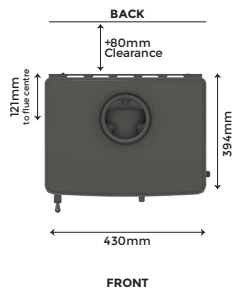

FRONT



SIDE

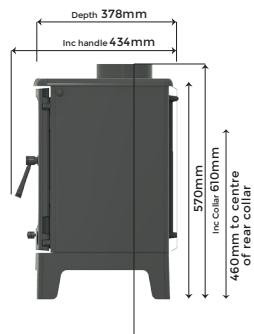

Operating parameters

| | |
|--|------------------------------|
| Nominal heat output | 8kW |
| Ideal operating temperature range | 150 - 300°C |
| Efficiency | 80.3% Wood 82% Anthracite |

Warranty



Vue (Landscape)

5kW (N. 8kW) Multi Fuel
Free Standing

PLEASE RETURN TO THE RETAILER

*FAILURE TO DO SO WILL
AFFECT THE WARRANTY*

Your stove is guaranteed **for 5 years*** from date of purchase

**Excluding consumable parts - Vermiculite / rope / glass / grate*

This document must be completed by the installer; this constitutes a 'Hearth Notice' for purposes of the England and Wales Building Regulations 2000.

To be completed by the Installation Engineer:

| | |
|--|--|
| Model | |
| Serial number | |
| Installer's name | |
| Registration number | |
| Date | |
| Installation Contact <small>Only used for the purposes of administrating the warranty</small> | |

Who certifies that this installation is safe, has been demonstrated to the householder, conforms to current building regulations, has at least a 12Pa flue draught measurement and has been through these instructions with the owner of the appliance.

| | |
|-----------------------------|--------------------|
| Commissioned by (Signature) | Pascal Measurement |
| | |

TO FIND A QUALIFIED INSTALLER, FUEL SUPPLIER or CHIMNEY SWEEP, CONTACT:

UK | The Solid Fuel Association, 95 High Street, Clay Cross, Chesterfield, Derbyshire, S45 9DZ, England | Tel: 0845-601-4406 | www.solidfuel.co.uk
ROI | Irish Nationwide Fireplace Organisation, P.O. Box 11563, Finglas, Dublin 11, County Dublin, Ireland | Tel: 086-236-6553 | www.fireplace.ie



F2 FIRES

Thank you

for choosing

F2 Fires

sit back, relax and enjoy...