

**CHARNWOOD
COUNTRY 6 FT**

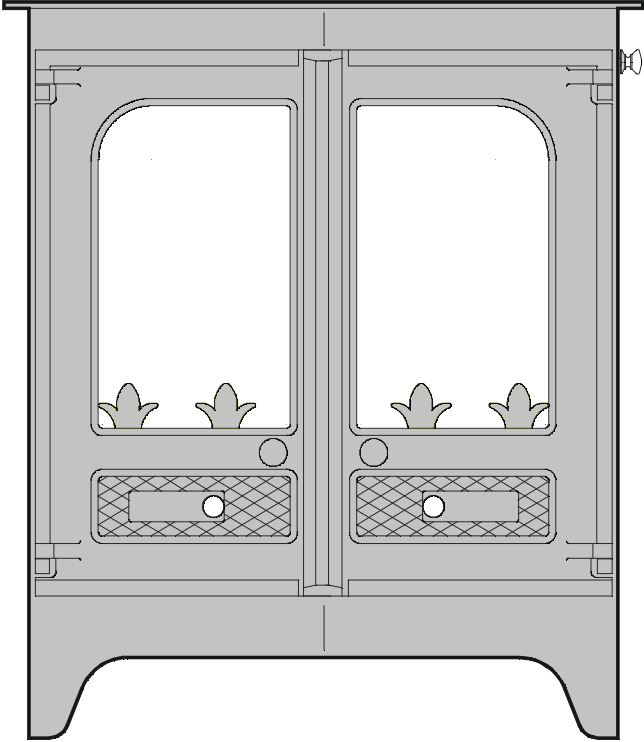

**Operating
and
Installation Instructions**



A. J. WELLS & SONS

CHARNWOOD COUNTRY 6 OPERATING INSTRUCTIONS

Before lighting the stove check with the installer that the work and checks described in the Installation Instructions have been carried out correctly and that the chimney has been swept, is sound and free from any obstructions.

FUELS

Wood

Wood must be dry and well seasoned. Ideally it should be cut, split and stacked under cover for at least a year and preferably two years before being burnt. Hard woods, such as Ash, Beech and Oak are preferable to Soft woods such as Pine.

The wood should be burnt in a bed of ash on the flat base of the stove.

Burning wet unseasoned wood will result in heavy tar deposits in the chimney and reduced outputs.

Peat

Cut peat should be dried before burning to reduce tar deposits. Peat should be burnt in the same manner as wood, on the flat base of the stove in a bed of ash.

House Coal

Doubles, Trebles and Cobbles may be burnt, do not use singles or coal dust (or "slack"). Coal must only be burnt with the optional coal kit, burning it on the flat base of the stove may cause damage. A little extra care is needed when burning coal, please refer to the section "Special Points When Burning House Coal" later in the instructions.

Smokeless Fuel

A wide variety of smokeless fuels are available, many of which are suitable for use on your Country 6. Some of these are listed below:

Ancit
Anthracite Large Nuts
Centurion
Extracite
Homefire
Maxibrite
Phurnacite
Welsh Dry Steam Coal (Large Nuts).

Smokeless fuels must only be burnt with the optional coal kit, burning it on the flat base of the stove may cause damage.

At first you may find it helpful to try several fuels to find the most suitable. If you are unable to obtain the fuel you want ask your supplier, or an approved fuel distributor to suggest an alternative.

Only smokeless fuels may be burnt in smoke control areas.

**PETROLEUM COKE IS NOT
SUITABLE FOR USE ON THIS
APPLIANCE, ITS USE WILL
INVALIDATE THE GUARANTEE**

DOOR OPERATION

Using the tool turn the right-hand door knob anti-clockwise to open and clockwise to close, (see Fig. 1.)

FITTING THE OPTIONAL COAL KIT

Before burning coal or smokeless fuel the coal kit must be fitted. This consists of a grate and an ashpan.

Remove the front fence and place the grate in the stove so that it comes

hard up against the back fire brick. Replace the front fence so that the slope rests on the top of the grate. Slide the ashpan in under the grate.

LIGHTING

On initial lighting, the stove may smoke and give off an odour as the silicon paint with which the firebox is painted reacts to the heat. This is normal and will cease after a short time, but meanwhile the room should be kept well ventilated.

At first only light a small fire and burn it slowly for two hours to allow any residual moisture in the bricks to evaporate.

IMPORTANT When burning wood or peat on the base of the stove there must be a bed of ash to prevent damage to the base. When first lighting the stove, if there is no ash available then a make a layer of sand or earth about 12mm (1/2 inch) thick on the base to prevent any damage.

The stove may be lit using dry kindling wood and paper or fire lighters. Place the paper, or fire

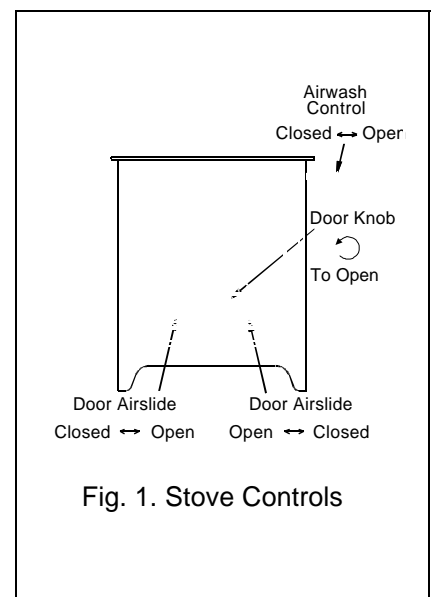

Fig. 1. Stove Controls

lighters, and kindling on the base or the grate and cover with approximately 2 inches of fuel. Open the air slides in the doors and open the airwash control fully (see Fig. 1). Light the paper or fire lighters. Close the doors until the fuel is well ignited then load with fuel and adjust the air controls to the required setting.

When relighting the stove, leave the ash on the base, if burning wood or peat, unless it is beginning to block the slots in the front fence, in which case some of it may be removed. If burning solid fuel clear the grate and empty the ashpan before relighting.

CONTROLLING THE FIRE

The rate of burning and hence the output is controlled by the door air slides and the airwash control (see Fig. 1).

The air slides in the doors should be used when lighting or when rapid burning is required. They should not be left fully open for long periods as this can cause over-firing. For overnight burning they should be closed.

The airwash control is used most of the time to control the burning rate and to keep the glass clean. Fully extended gives full airwash for faster burning and clean glass whereas fully closed gives slow overnight burning. It will not be possible to keep the glass clean if this control is fully closed, particularly after refuelling.

REFUELLING

Keep the firebox well filled but do not allow fuel to spill over the top of the front fire bars.

Care should be taken, especially when burning wood, that fuel does not project over the front fire bars or damage to the glass may be caused when the doors are closed, it can also cause the glass to black up.

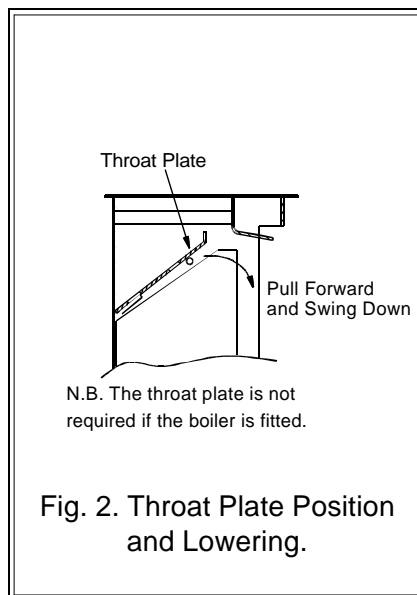

Fig. 2. Throat Plate Position and Lowering.

ASH CLEARANCE

When burning wood or peat the ash should be allowed to build up on the base of the fire. It will only be necessary to remove some ash once or twice a week when it begins to restrict the flow of air through the front fence.

When burning coal or smokeless fuel the ashpan should be emptied regularly before it becomes too full, generally once or twice a day. Never allow the ash to accumulate in the ashpan so that it comes in contact with the underside of the grate as this will seriously damage the grate. Care should be taken to ensure that ash is cool before emptying it into plastic liners or bins. After emptying the ashpan, poke the fire with a poker to clear the firebed of ash.

To make ash removal easier, when burning coal or smokeless fuel, there is a special Charnwood ash carrier available. This enables the whole ashpan to be placed in the sealed carrier and taken outside. These may be purchased from your supplier or, in case of difficulty, from ourselves.

SPECIAL POINTS WHEN BURNING HOUSE COAL

When loading the stove take care not to smother the fire, instead fill the firebox in two stages waiting between each stage for the flames to appear above the fire.

After a period of slumbering always open the door air slides and wait until flames appear above the fuel bed before opening the doors.

Burning coal will produce more soot deposits than other fuels, especially if the fire is run at low levels for long periods. It is therefore vital to clean the throat plate regularly, weekly cleaning is recommended.

Never fully close the Airwash control when burning coal.

RUNNING THE FIRE WITH THE DOORS OPEN

The fire may be run with the doors open if required. The more reactive fuels, such as wood, peat, coal and homefire, will burn better with the doors open than fuels like phurnacite and ancit. Do not leave the fire unattended with the doors open.

OVERNIGHT BURNING

For overnight burning the fire doors must be closed.

When burning wood load some large logs on the fire and allow to burn for half an hour before closing the door air slides, (this will help to reduce tar deposits in the chimney.) Leave the airwash control slightly open to help keep the glass clear.

When burning coal or smokeless fuel, if the fire is very low then open the air controls and revive the fire, adding a small amount of fuel if necessary. Empty the ashpan and

poke the fire, load with fuel, and then close the door air slides. The airwash control should be kept slightly open to help keep the door glass clean.

Some experimentation may be necessary to find the setting most suitable for the type of fuel being used and the draw on the chimney.

To revive the fire, empty the ashpan, (if burning coal or smokeless fuel), poke the fire, and open the air controls to maximum. When the fire is burning well load on more fuel as necessary and adjust the air controls to the desired setting.

CLEANING AND MAINTENANCE

The stove is finished with a high temperature paint which will withstand the temperatures encountered in normal use. This may be cleaned with a damp lint-free cloth when the stove is cold. Should re-painting become necessary, high temperature paints are available from your supplier or from stove shops.

Most deposits on the glass may be burnt off simply by running the fire at a fast rate for a few minutes. If it becomes necessary to clean the glass then open the doors and allow them to cool. Clean the glass using a damp cloth and then wiping over with a dry cloth. Any stubborn deposits on the glass may be removed with a proprietary stove glass cleaner or ceramic hob cleaner. Do not use abrasive cleaners or pads as these can scratch the surface which will weaken the glass and cause premature failure.

THROAT PLATE AND FLUEWAY CLEANING

It is important that the throat plate and all the stove flueways are kept clean in order to prevent potentially dangerous fume emission. They should be cleaned at least monthly, and more frequently if necessary. It is

necessary to let the fire out completely to carry out these operations.

The front of the throat plate is pulled forward and then lowered as shown in Fig. 2. Any sooty deposits should then be swept from the plate and into the fire.

Return the throat plate to its correct position - raise the front of the plate, push it back and then lower it onto the retaining lugs.

CHIMNEY SWEEPING

The chimney should be swept at least twice a year. Where the top outlet or vertical rear flue connector is used it will generally be possible to sweep the chimney through the appliance.

First remove the front fence and the throat plate. Then sweep the chimney ensuring that soot is removed from all horizontal surfaces after sweeping.

In situations where it is not possible to sweep through the appliance the installer will have provided alternative means, such as a soot door. After sweeping the chimney the appliance flue outlet and the flue pipe connecting the stove to the chimney must be cleaned with a flue brush.

After clearing any soot from within the stove, replace the throat plate (see Fig. 2.) and the front fence.

Different types of sweep's brushes are available to suit different flueways. For standard brick chimneys a wire centre sweep's brush fitted with a guide wheel is recommended. For prefabricated insulated chimneys the manufacturers instructions with regard to sweeping should be consulted.

TROUBLE SHOOTING

Fire Will Not Burn.

Check that:

a) the air inlet is not obstructed in any way,

- b) chimneys and flueways are clear,
- c) that a suitable fuel is being used,
- d) that there is an adequate air supply into the room,
- e) that an extractor fan is not fitted in the same room as the stove.
- f) there is sufficient draw in the chimney. Once the chimney is warm a draught reading of at least 2.5 mm (0.10 inches) water gauge should be obtained.

Door Glass Blacks Up

Differences in chimney draughts mean that the best settings of the air controls will vary for different installations. A certain amount of experimentation may be required, however the following points should be noted and with a little care should enable the glass to be kept clean in most situations:

- a) The airwash relies on a supply of heated air to keep the glass clean, therefore, when lighting the stove allow the firebed to become well established before closing the airslides. This may also be necessary when re-fuelling the stove.
- b) When re-fuelling keep the fuel as far back from the front fence as possible, do not try to fit too much fuel into the firebox.
- c) Never completely close the airwash control - as a guide it should be at least a quarter open.
- d) The airslides in the doors may be kept slightly open to assist in keeping the glass clean.
- e) Wet wood or logs overhanging the front fence will cause the glass to blacken.

It is always more difficult to keep the glass clean when running the stove very slowly for long periods.

If blackening of the glass still occurs check that all flue connections and the blanking plate are well sealed. It is also important that the chimney draw is sufficient and that it is not affected by down-draught.. When the

chimney is warm a draught reading of at least 2.5 mm (0.10 inches) water gauge should be obtained.

When burning coal some blackening of the glass may occur below the level of the front fence. This will not obscure the view of the fire or affect its performance.

Fume Emission.

Warning Note: Properly installed and operated this appliance will not emit fumes. Occasional fume from de-ashing and re-fuelling may occur. Persistent fume emission is potentially dangerous and must not be tolerated. If fume emission does persist, then the following immediate actions should be taken:

- a) **Open doors and windows to ventilate the room.**
- b) **Let the fire out and safely dispose of the fuel from the**

appliance.

- c) **Check for flue or chimney blockage, and clean if required.**
- d) **Do not attempt to re-light the fire until cause of fume has been identified, if necessary seek professional advice.**

The most common cause of fume emission is flueway or chimney blockage. For your own safety these must be kept clean.

Fire blazing out of control

Check that :

- a) The doors are tightly closed.
- b) The airslides are turned down to the minimum setting.
- c) The airwash control is closed.
- d) A suitable fuel is being used.
- e) Door seals and airwash slide are intact.

Chimney Fires.

If the chimney is thoroughly and regularly swept, chimney fires should not occur. However, if a chimney fire does occur close the door air slides and the airwash control, and tightly close the doors of the appliance. This should cause the chimney fire to go out in which case the controls should be kept closed until the stove has gone out. The chimney and flueways should then be cleaned. If the chimney fire does not go out when the above action is taken then the fire brigade should be called immediately.

After a chimney fire the chimney should be carefully examined for any damage. Expert advice should be sought if necessary.

CHARNWOOD COUNTRY 6 INSTALLATION INSTRUCTIONS

HEALTH AND SAFETY PRECAUTIONS

Please take care when installing the stove that the requirements of the Health and Safety at Work Act 1974 are met.

Some types of fire cement are caustic and should not be allowed to come into contact with the skin. In case of contact wash with plenty of water.

If there is a possibility of disturbing any asbestos in the course of installation then please use appropriate protective equipment.

There must not be an extractor fan fitted in the same room as the stove as this can cause the appliance to emit fumes into the room.

There must be an adequate air supply into the room in which the appliance is installed totalling at least 100 square cm. (16 square inches) to provide combustion air. This is particularly necessary if the room is double glazed.

In addition to these instructions the requirements of BS.8303 and BS.6461 Pt 1&2; 1984 must be fulfilled. Local Authority Bylaws and Building Regulations regarding the installation of Solid Fuel burning appliances, flues and chimneys must also be observed.

PERFORMANCE

The output of the Country 6 is 6.0 kW (20,500 Btu/h). The optional add-in boiler has an output of 2.9 kW (10,000 Btu/h), if the boiler is fitted then the heat output to the room will be reduced by this amount.

These outputs are based on a 2 hourly re-fuelling cycle burning seasoned hardwood logs, or a 4 hourly

re-fuelling cycle burning smokeless fuel.

CHIMNEY

In order for the appliance to perform satisfactorily the chimney height must not be less than 4 metres measured vertically from the outlet of the stove to the top of the chimney. The internal dimensions of the chimney should preferably be 175 mm (7 inches) or 200mm (8 inches) either square or round and **MUST NOT BE LESS THAN 150 mm (6 INCHES)**.

If an existing chimney is to be used it must be swept and checked, it must be in good condition, free from cracks and blockages, and should not have an excessive cross sectional area. If you find that the chimney is in poor condition then expert advice should be sought regarding the necessity of having the chimney lined. If it is found necessary to line the chimney then a lining suitable for Solid Fuel must be used.

If there is no existing chimney then a prefabricated block chimney or a twin walled insulated stainless steel flue to BS.4543 can be used either internally or externally. These chimneys must be fitted in accordance with the manufacturers instructions and Building Regulations.

Anki pumice liners or chimney blocks will give a highly insulated chimney which will work well with all fuels. For details ring (01983) 527997.

Single wall flue pipe is suitable for connecting the stove to the chimney but is not suitable for using for the complete chimney.

If it is found that there is excessive draw in the chimney then a draught

stabilizer should be fitted.

It is important that there is sufficient draw in the chimney and that the chimney does not suffer from down-draught. When the chimney is warm the draw should be not less than 2.5mm (0.10 inches) water gauge. If in doubt about the chimney seek expert advice.

HEARTH AND FIRE SURROUND

The stove must stand on a fireproof hearth and must be situated at least 300mm (12 inches) from any combustible material. There must be a gap behind the stove of at least 25mm to allow air to enter the airwash inlets. The positioning of the stove and the size of the hearth are governed by building regulations for Class 1 appliances. These building regulations state that the hearth must extend in front of the stove by at least 300mm (12 inches) and to the sides of the stove by at least 150mm (6 inches). If in doubt as to the positioning of the stove expert advice should be sought either from the supplier or the local building inspector.

The fireplace must allow good circulation of air around the appliance to ensure that maximum heat is transferred to the room and also to prevent the fireplace from overheating. A gap of 150mm (6 inches) each side and 300mm (12 inches) above the appliance should give sufficient air circulation. If a wooden mantelpiece or beam is used in the fireplace it should be a minimum of 460mm (18 inches), and preferably 600mm (24 inches) from the appliance. In some situations it may be necessary to shield the beam or mantelpiece to protect it.

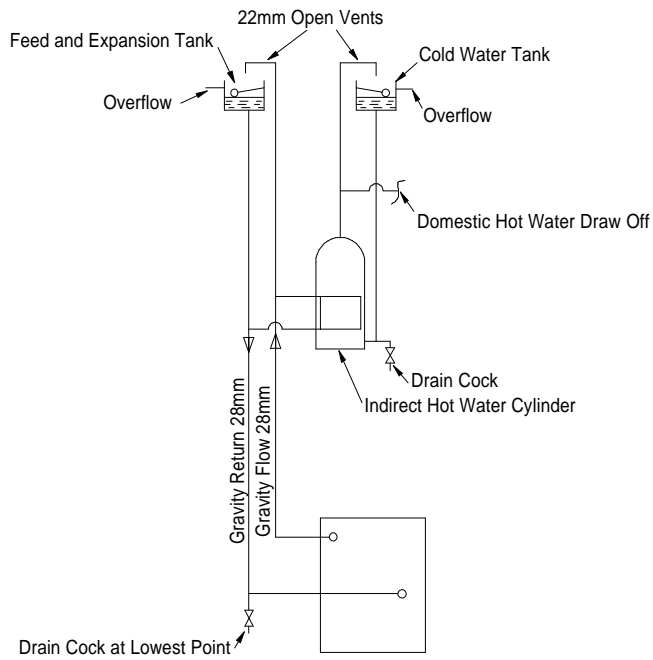

Fig. 3. Typical Gravity Hot Water System

HOT WATER SYSTEM

The optional add-in boiler which may be fitted in the appliance has an output sufficient for domestic hot water heating. If the boiler is fitted then the room heating will be reduced.

The hot water system should be a gravity circuit and must be correctly vented as shown in Fig. 3.

A double feed indirect hot water storage cylinder to BS:1566 part 1 should be used in most situations with the standard steel boiler. If the appliance is to be fitted in a soft water area then a direct hot water cylinder may be used provided that the stainless steel boiler is fitted.

All pipework in the primary circuit must be 28mm diameter and the flow pipe must rise continuously from the boiler to the open vent.

If an indirect cylinder is used then the primary circuit should be filled

with a suitable inhibitor to prevent the build up of scale and corrosion.

FITTING THE OPTIONAL ADD-IN BOILER

The boiler replaces the rear firebrick and the throat plate.

Before fitting the boiler, remove the front fence, the throat plate and the rear firebrick. Knock out the knock-outs for the boiler tappings in the back of the firebox.

Fit one back nut on the flow tapping to come flush with the back face of the boiler, and fit the boiler into the appliance. Place the fibre washers over the tappings on the outside of the appliance and fit the two remaining backnuts, ensuring that the boiler is held tightly against the rear inside face of the appliance and that the top edge of the boiler is level or runs uphill to the flow tapping.

Gaps between the boiler and the

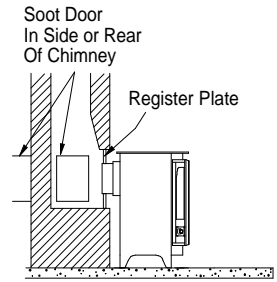

Fig. 4. Vertical Register Plate With Bricked Up Fireplace

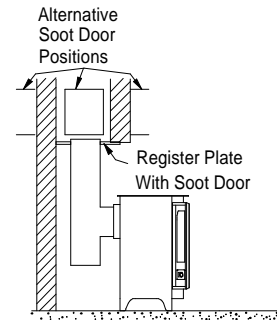

Fig. 5. Horizontal Register Plate With Rear Flue Connection

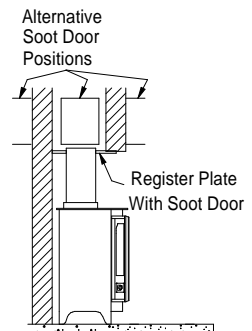

Fig. 6. Horizontal Register Plate With Top Flue Connection

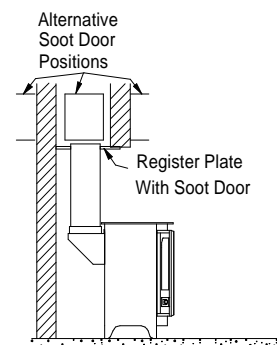
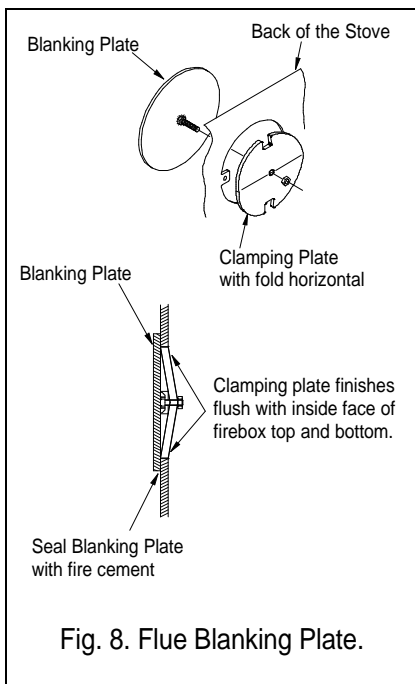

Fig. 7. Horizontal Register Plate With Optional Vertical Rear Flue Connector



firebricks should be filled with fire cement.

Connect the boiler to the heating system ensuring that the flow pipe rises from the boiler. Fill the system with water and check for leaks.

CONNECTIONS TO FLUES

There are several ways of connecting the stove to the flue. These are illustrated in Figs. 4 to 7.

If the optional vertical rear flue connector is used and no boiler is fitted then the chimney may be swept through the appliance.

Horizontal lengths of flue must be kept to a minimum and should not be more than 150mm (6 inches) long. The sealing face of the flue collar must be coated with fire cement before fixing to the body of the stove using the two screws provided. The blanking plate must be removed, sealed with fire cement and refitted, care being taken to ensure that the fold on the blanking plate is in line with the lugs on the firebox as shown in Fig. 8. Ensure that the clamping plate does not prevent the throat plate from seating correctly. All flue connections must be well sealed.

SOOT DOORS

It is possible to pass a 16 inch diameter sweeps brush through the appliance but in most back outlet installations it will be necessary to have a soot door to enable the chimney to be swept. The optional vertical rear flue connector does allow the chimney to be swept through the stove, except when a boiler is fitted.

Soot doors may either be in the actual brickwork of the chimney or in the register plate. Various positions of

soot doors are shown in Figs. 4 to 7.

PRE LIGHTING CHECK

If the optional boiler is fitted, then the throat plate is not required.

If the optional boiler is not fitted then ensure that the throat plate is fitted in the roof of the appliance. The location and positioning of the throat plate is shown in Fig. 2.

Before initial lighting check that the front fence is fitted correctly and that the doors tighten properly.

COMMISSIONING

On completion of the installation and after allowing a suitable period of time for the fire cement and mortar to dry out, make a layer of ash or sand on the base of the stove before lighting it and checking to ensure that smoke and fumes are taken from the appliance up the chimney and emitted safely. Also check all joints and seals. On completion of the installation and commissioning please leave the operating instructions with the customer and advise them on the use of the appliance.

