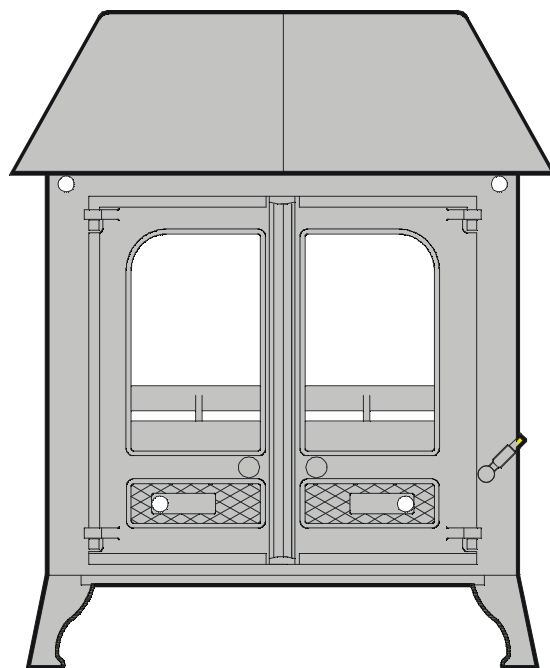


**CHARNWOOD**  
**Country 8 MkII and Country 12 MkII**  
**Flat Top, Low Canopy & High Canopy**  
**Multifuel Roomheaters**



**Operating**  
**and**  
**Installation Instructions**



**A. J. WELLS & SONS**

# CHARNWOOD

## COUNTRY 8 Mk II & COUNTRY 12 Mk II

### Operating and Installation Instructions

## Contents

### Operating Instructions

Fuels.....	3
Door Operation.....	3
Multifuel Grate.....	3
Lighting.....	4
Controlling The Fire.....	4
Riddling .....	4
Refuelling .....	4
Ash Clearance .....	4
Special Points When Burning Coal.....	4
Special Points When Burning Wood and Peat....	4
Overnight Burning .....	5
Maintenance .....	5
Throat Plate & Flueway Cleaning.....	5
Chimney Sweeping.....	5
Trouble Shooting.....	6

### Installation Instructions

Health & Safety Precautions .....	7
Performance.....	7
Chimney .....	7
Hearth and Fire Surround.....	7
Hot Water System.....	7
Fitting The Optional Add-In Boiler.....	8
Connections To Flues .....	8
Soot Doors.....	9
Pre-Lighting Check .....	9
Commissioning.....	9
Overall Dimensions Country 8 .....	10
Overall Dimensions Country 12 .....	11



**A. J. WELLS & SONS**

Bishops Way, Newport, Isle of Wight, PO30 5WS, U.K.

Tel: (01983) 537799 Fax: (01983) 537788

E-Mail: [charnwood@ajwells.co.uk](mailto:charnwood@ajwells.co.uk)

# OPERATING INSTRUCTIONS FOR THE CHARNWOOD COUNTRY 8 MkII & COUNTRY 12 MkII

Before lighting the stove check with the installer that the work and checks described in the Installation Instructions have been carried out correctly and that the chimney has been swept, is sound and free from any obstructions.

## FUELS

The following fuels may be burnt on this stove. Please pay careful attention to the special points made with each type of fuel as they will help you to get the best from your stove. It must be remembered that only smokeless fuels may be burnt in smoke control areas on this stove. If you are not sure whether you are in a smoke control area, then please check with your Local Authority.

### Smokeless Fuels

The recommended smokeless fuels which are suitable for use in smoke control areas on this stove are as follows:

Ancit, (Phurnacite Plus)  
Anthracite Large Nuts,  
Cosycoke  
Homefire,  
Maxibrite,  
Phurnacite,  
Sunbrite Doubles,  
Welsh Dry Steam Coal (Large Nuts).

### Coal

Housecoal doubles, trebles or cobbles may all be burnt. Do not use singles, small nuts, or coal dust

It is important that large size coal is used (ie. larger than 2 inch or 50 mm in size). The coal should be dry.

When burning bituminous coal a little extra care is needed. Please take note of the section "Special Points For Burning Coal".

## Wood

Only dry well seasoned wood should be burnt on this appliance as burning wet unseasoned wood will give rise to heavy tar deposits in the stove, on the glass and within the chimney. For the same reason hard wood is better than soft wood. Burning wet unseasoned wood will also result in considerably reduced outputs. The wood should be cut and split and then left to season in a well ventilated dry place for at least one year but preferably two years before use.

## Peat

Ensure that the peat is well dried before use. Burning wet peat will give rise to heavy tar deposits and reduced outputs.

**PETROLEUM COKE IS NOT  
SUITABLE FOR USE ON THIS  
APPLIANCE. ITS USE WILL  
INVALIDATE THE  
GUARANTEE.**

At first you may find it helpful to try several fuels to find the most suitable. If you are unable to obtain the fuel you want ask your supplier, or an approved fuel distributor to suggest an alternative.

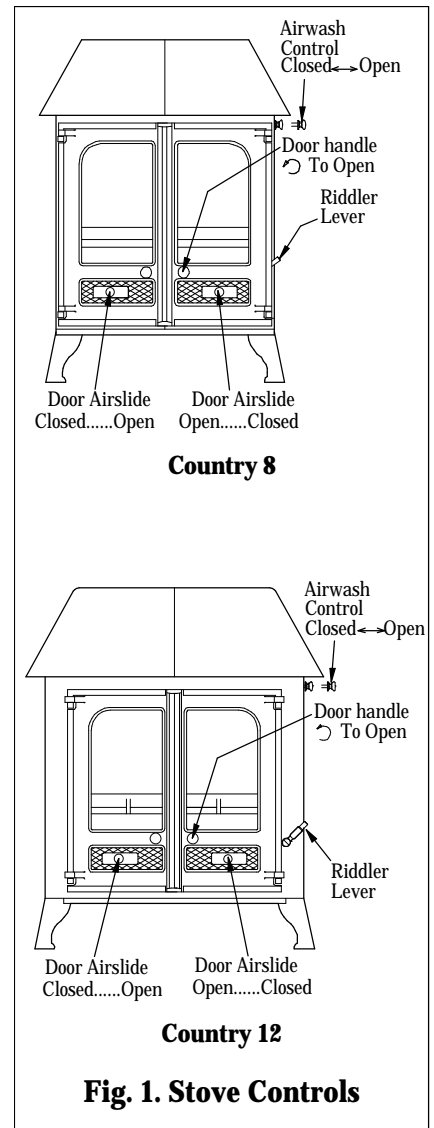
## DOOR OPERATION

Use the door opening and ashpan tool to open and close the doors. Turn the right-hand door knob anti-clockwise to open and clockwise to close.(see Fig. 1)

## MULTIFUEL GRATE

Your Charnwood stove is fitted with a multifuel grate which enables both solid fuels and wood to be burned equally effectively. The grate has two positions:-

1) In the solid fuel position the grate



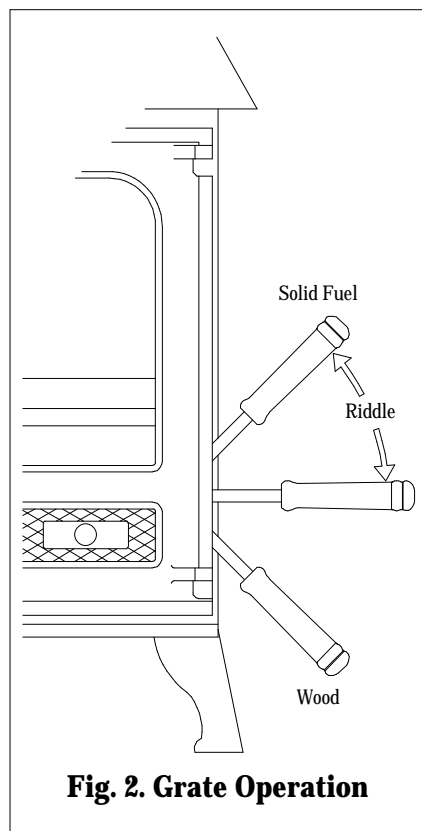
**Fig. 1. Stove Controls**

bars are vertical with gaps in between allowing the primary combustion air to come up through the grate and through the fuel bed.

2) In the wood position the grate bars are horizontal, allowing the combustion air to come round the sides of the grate and over the top of it. When in the wood position ash is able to build up on the grate as is necessary for effective wood or peat burning.

Movement of the grate from one position to the other is effected using the tool supplied as shown in Fig. 2. The grate is put into the solid fuel

position by moving the tool up until the handle is in the 1 o'clock position. The grate is put into the wood position by moving the tool down until the handle is in the 5 o'clock position. To riddle the appliance when burning solid fuels the tool should be moved between the 1 o'clock and 3 o'clock positions several times. When burning wood or peat the ash should be allowed to build up and riddling should only be carried out once or twice a week.



**Fig. 2. Grate Operation**

## LIGHTING

The stove may be lit using dry kindling wood and paper or fire lighters. Set the grate into either the wood position or the solid fuel position as required. Place the paper, or fire lighters, and kindling on the grate and cover with approximately 2 inches of fuel. Open the air slides in the doors and open the airwash control fully (see fig. 1). Light the paper or fire lighters. Close the doors until the fuel is well ignited then load with fuel and adjust the air controls to the required setting.

On initial lighting, the stove may smoke and give off an odour as the silicon paint with which the firebox is painted reacts to the heat. This is

normal and will cease after a short time, but meanwhile the room should be kept well ventilated.

At first only light a small fire and burn it slowly for two hours to allow any residual moisture in the bricks to evaporate.

When relighting the stove, riddle (if burning solid fuel), remove any clinker from the firebed and then empty the ashpan.

## CONTROLLING THE FIRE

The rate of burning and hence the output is controlled by the door air slides and the airwash control (see Fig. 1).

The door airslides are used when lighting and requiring rapid heating. They may be left slightly open to help keep the glass clean.

The airwash control is used most of the time to control the burning rate and to keep the glass clean. Fully extended gives full airwash for faster burning and clean glass whereas fully closed gives slow overnight burning. It will not be possible to keep the glass clean if this control is fully closed, particularly after refuelling.

## RIDDLING

When burning solid fuels riddling twice a day is usually sufficient. When burning wood or peat, ash should be allowed to build up and generally weekly riddling will be sufficient. The fire should be riddled with the doors shut (see Fig 2.) Place the tool onto the riddling lever and rotate between the 1 o'clock and 3 o'clock positions several times. Too much riddling can result in emptying unburnt fuel into the ashpan and should therefore be avoided. If any clinker forms it should be removed from the firebed. After riddling, the grate should be put back into the solid fuel or wood position as required (the tool should be in the 1 o'clock position for solid fuel or in the 5 o'clock position for wood).

## REFUELLING

Keep the firebox well filled but do

not overfill to prevent fuel from spilling over the top of the front fire bars.

Care should be taken especially when burning wood that fuel does not project over the front fire bars or damage to the glass may be caused when the doors are closed, it can also cause the glass to black up .

## ASH CLEARANCE

The ashpan should be emptied regularly before it becomes too full. Never allow the ash to accumulate in the ashpan so that it comes in contact with the underside of the grate as this will seriously damage the grate bars. The ashpan is handled using the tool provided. Care should be taken to ensure that ash is cool before emptying it into plastic liners or bins.

To make ash removal easier there is a special Charnwood ash carrier available. This may be purchased from your supplier or, in case of difficulty, from ourselves.

## SPECIAL POINTS WHEN BURNING COAL

When loading the stove take care not to smother the fire, instead fill the firebox in two stages waiting between each stage for the flames to appear above the fire.

After a period of slumbering always turn the air control up to maximum and wait until flames appear above the fuel bed before opening the doors.

Burning coal will produce more soot deposits than other fuels, especially if the fire is run at low levels for long periods. It is therefore vital to clean the throat plate regularly, weekly cleaning is recommended.

Never fully close the Airwash control when burning coal.

## SPECIAL POINTS WHEN BURNING WOOD AND PEAT

The grate should be kept in the wood burning position and should not be riddled until the ash becomes so deep

that it begins to block the passage of air into the firebox at the side of the grate. When this is the case do not remove all of the ash using the riddling mechanism but keep a layer about half an inch thick as this enables the wood to burn more effectively. When burning wood or peat use the airwash control in the same way as described (see "CONTROLLING THE FIRE" )but keep the door airslides closed once the desired temperature has been reached.

## OVERNIGHT BURNING

For overnight burning the fire doors must be closed.

When burning solid fuel the ashpan should be emptied and the fire riddled. The air controls should be turned up to maximum for a brief period and then when the fire is burning brightly it should be loaded with fuel. When the new fuel has ignited, the door airslides should be almost closed and the airwash control moved to a low setting. Some experimentation will be necessary to find the settings most suitable for the particular fuel used and the draw on the chimney. To revive the fire, empty the ashpan, riddle, and open the air controls to maximum. When the fire is burning well load on more fuel as necessary and move the air controls to the desired setting.

When burning wood use large logs rather than small ones. Proceed as above, but do not riddle the fire either when shutting down or reviving.

## MAINTENANCE

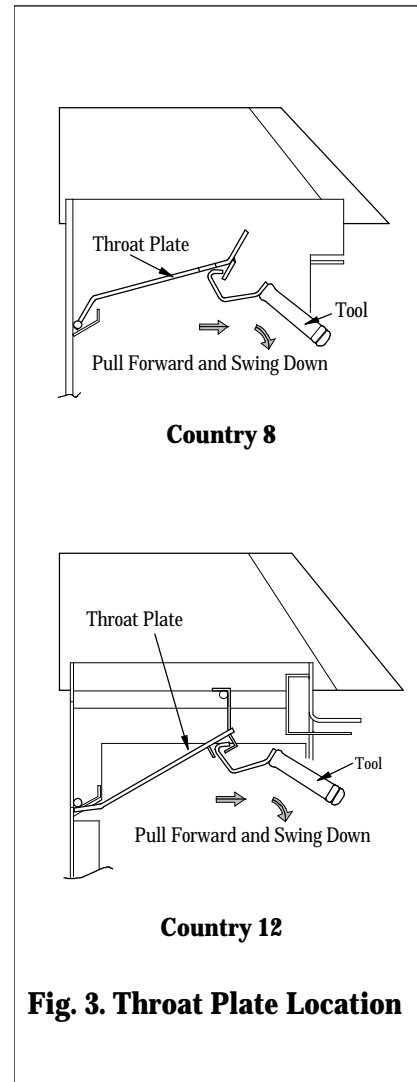
### Cleaning

The stove is finished with a high temperature paint which will withstand the temperatures encountered in normal use. This may be cleaned with a damp lint-free cloth when the stove is cold. Should re-painting become necessary, high temperature paints are available from your supplier or from stove shops.

### Cleaning the Glass

The glass in the doors is a special ceramic glass which is able to

withstand high temperatures. Before cleaning the glass open the doors and allow them to cool. Clean the glass using a damp cloth and then wiping over with a dry cloth. Any stubborn deposits on the glass may be removed with a proprietary stove glass cleaner or ceramic hob cleaner. Some deposits on the glass may be burnt off simply by running the fire at a fast rate for a few minutes. Do not use



**Fig. 3. Throat Plate Location**

abrasive cleaners or pads as these can scratch the surface which will weaken the glass and cause premature failure. Aerosol spray cleaners should not be used near the appliance whilst it is under fire.

### When not in use

If the fire is going to be out of use for a long period, (for instance in the summer,) then to prevent condensation, and hence corrosion, the thermostat should be left at the maximum setting and the main doors

left ajar. It is also advisable to sweep the chimney and clean out the fire. Spraying the inside of the doors and firebox with a light oil, such as WD40, will also help to keep all internal parts working well.

After long periods where the fire has been out of use, the chimney and appliance flueways should be cleaned before lighting.

### Door Seals

For the fire to operate correctly it is important that the door seals are in good condition. Check that they do not become worn or frayed and replace them when necessary.

### Servicing

It is recommended that the fire is serviced once a year to keep it in first class working order. After cleaning out the firebox thoroughly, check that all internal parts are in good working order, replacing any parts that are beginning to show signs of wear. Check that the doors seals are in good condition and that the doors seal correctly. A servicing guide is available on request.

## THROAT PLATE AND FLUEWAY CLEANING

It is important that the throat plate and all the stove flueways are kept clean. When burning smokeless fuels they should be cleaned monthly. When burning other fuels they should be cleaned at least once a week, and more frequently if necessary. It is not necessary to let the fire out completely to carry out these operations.

The throat plate is lowered using the tool. The front of the throat plate is pulled forward and then lowered as shown in figure 3. Any sooty deposits should then be swept from the plate and into the fire.

Return the throat plate to its correct position - raise the front of the plate, push it back and then lower it onto the retaining lugs.

## CHIMNEY SWEEPING

The chimney should be swept at least twice a year. Where a top outlet is used it will generally be possible to

sweep the chimney through the appliance.

First remove the side fire plates, front firebars and the throat plate. Then sweep the chimney ensuring that soot is removed from all horizontal surfaces after sweeping.

In situations where it is not possible to sweep through the appliance the installer will have provided alternative means, such as a soot door. After sweeping the chimney the appliance flue outlet and the flue pipe connecting the stove to the chimney must be cleaned with a flue brush.

After clearing any soot from within the stove, replace the throat plate (see fig. 3), the front firebars, and side fireplates.

Different types of sweep's brushes are available to suit different flueways. For standard brick chimneys a wire centre sweep's brush fitted with a guide wheel is recommended. For prefabricated insulated chimneys the manufacturers instructions with regard to sweeping should be consulted.

## TROUBLE SHOOTING

### Fire Will Not Burn.

Check that:

- a) the air inlet is not obstructed in any way,
- b) chimneys and flueways are clear,
- c) that a suitable fuel is being used,
- d) that there is an adequate air supply into the room,
- e) that an extractor fan is not fitted in the same room as the stove.
- f) there is sufficient draw in the chimney, (once the chimney is warm a draught reading of at least 0.10 inches water gauge should be obtained).

### Door Glass Blacks Up

Keeping the glass clean requires a certain amount of experimentation due to the differences in the draw of different chimneys. The following points should be noted and with a little care should enable the glass to be kept clean in most situations:

- a) The airwash relies on a supply of heated air to keep the glass clean,

therefore, when lighting the stove allow the firebed to become well established before closing the airslides. This may also be necessary when re-fuelling the stove.

- b) When re-fuelling keep the fuel as far back from the front firebars as possible, do not try to fit too much fuel into the firebox.

- c) Never completely close the airwash control - as a guide it should be at least a quarter open.

- d) The airslides in the doors may be kept slightly open to assist in keeping the glass clean.

- e) Wet wood or logs overhanging the front firebars will cause the glass to blacken.

It is always more difficult to keep the glass clean when running the stove very slowly for long periods.

If blackening of the glass still occurs check that the top of the stove is bolted on securely, and that the seal between the top and the body is intact. Also check that all flue connections and the blanking plate are well sealed. It is also important that the chimney draw is sufficient, (when the chimney is warm a draught reading of at least 0.10 inches water gauge should be obtained), and that it is not affected by down-draught.

When burning coal some blackening of the glass may occur below the level of the front firebars. This will not obscure the view of the fire or affect its performance.

### Fume Emission.

**Warning Note: Properly installed and operated this appliance will not emit fumes. Occasional fume from de-ashing and re-fuelling may occur. Persistent fume emission is potentially dangerous and must not be tolerated. If fume emission does persist, then the following immediate actions should be taken:**

- a) **Open doors and windows to ventilate the room.**
- b) **Let the fire out and safely dispose of the fuel from the appliance.**
- c) **Check for flue or chimney**

**blockage, and clean if required. d) Do not attempt to re-light the fire until cause of fume has been identified, if necessary seek professional advice.**

The most common cause of fume emission is flueway or chimney blockage. For your own safety these must be kept clean.

### Fire blazing out of control

Check that :

- a) The doors are tightly closed.
- b) The airslides are turned down to the minimum setting.
- c) The airwash control is closed.
- d) A suitable fuel is being used.
- e) Door seals and airwash slide are intact.

### Chimney Fires.

If the chimney is thoroughly and regularly swept, chimney fires should not occur. However, if a chimney fire does occur turn the controls to the minimum setting, and tightly close the doors of the appliance. This should cause the chimney fire to go out in which case the control should be kept at the minimum setting until the stove has gone out. The chimney and flueways should then be cleaned. If the chimney fire does not go out when the above action is taken then the fire brigade should be called immediately.

After a chimney fire the chimney should be carefully examined for any damage. Expert advice should be sought if necessary.

# INSTALLATION INSTRUCTIONS FOR THE CHARNWOOD COUNTRY 8 MkII & COUNTRY 12 MkII

## HEALTH AND SAFETY PRECAUTIONS

Please take care when installing the stove that the requirements of the Health and Safety at Work Act 1974 are met.

Some types of fire cement are caustic and should not be allowed to come into contact with the skin. In case of contact wash with plenty of water.

If there is a possibility of disturbing any asbestos in the course of installation then please use appropriate protective equipment.

There must not be an extractor fan fitted in the same room as the stove as this can cause the appliance to emit fumes into the room.

There must be an adequate air supply into the room in which the appliance is installed totalling at least 100 square cm. (16 square inches) to provide combustion air. This is particularly necessary if the room is double glazed.

In addition to these instructions the requirements of BS.8303 and BS.6461 Pt 1&2; 1984 must be fulfilled. Local Authority Bylaws and Building Regulations regarding the installation of Solid Fuel burning appliances, flues and chimneys must also be observed.

## PERFORMANCE

The output of the Country 12 LC and FT is 12.0 kW (40,900 Btu/h), the Country 12 HC output is 12.5kW (42650 Btu/h). The output of the Country 8 LC and FT is 8.0 kW (27,300 Btu/h) the Country 8 HC output is 8.5 kW (29,000 Btu/h). The optional add-in boilers for all Country models have an output of 2.9 kW (10,000 Btu/h), if the boiler is fitted then the heat output to the room will be reduced by this amount.

The outputs were obtained burning

smokeless fuel over a four hourly re-fuelling cycle.

## CHIMNEY

In order for the appliance to perform satisfactorily the chimney height must not be less than 4 metres measured vertically from the outlet of the stove to the top of the chimney. The chimney should preferably be 175 mm (7 inches) or 200mm (8 inches) internal diameter or square with sides of 175mm or 200mm internally and **must not be less than 150 mm (6 inches) internal diameter or 150 x 150mm internal square.**

If an existing chimney is to be used it must be in good condition, free from cracks and blockages, and should not have an excessive cross sectional area. If you find that the chimney is in poor condition then expert advice should be sought regarding the necessity of having the chimney lined. If it is found necessary to line the chimney then a lining suitable for Solid Fuel must be used.

If there is no existing chimney then a prefabricated block chimney or a twin walled insulated stainless steel flue to BS.4543 can be used either internally or externally. These chimneys must be fitted in accordance with the manufacturers instructions and Building Regulations.

Single wall flue pipe is suitable for connecting the stove to the chimney but is not suitable for using for the complete chimney.

If it is found that there is excessive draw in the chimney then a draught stabilizer should be fitted.

It is important that there is sufficient draw in the chimney and that the chimney does not suffer from down-draught. When the chimney is warm the draw should be not less than 0.10 inches water gauge. If in

doubt about the chimney seek expert advice.

## HEARTH AND FIRE SURROUND

The stove must stand on a fireproof hearth and must be situated at least 300mm (12 inches) from any combustible material. The positioning of the stove and the size of the hearth are governed by building regulations for Class 1 appliances. These building regulations state that the hearth must extend in front of the stove by at least 300mm (12 inches) and to the sides of the stove by at least 150mm (6 inches). If in doubt as to the positioning of the stove expert advice should be sought either from the supplier or the local building inspector.

The fireplace must allow good circulation of air around the appliance to ensure that maximum heat is transferred to the room and also to prevent the fireplace from overheating. A gap of 150mm (6 inches) each side and 300mm (12 inches) above the appliance should give sufficient air circulation. If a wooden mantelpiece or beam is used in the fireplace it should be a minimum of 460mm (18 inches), and preferably 600mm (24 inches) from the appliance. In some situations it may be necessary to shield the beam or mantelpiece to protect it.

In order for the airwash to operate correctly there must be an air gap behind the appliance of at least 25mm.

## HOT WATER SYSTEM

The optional add-in boiler which may be fitted in the appliance has an output sufficient for domestic hot water heating. If the boiler is fitted then the room heating will be reduced.

The hot water system should be a gravity circuit and must be correctly vented as shown in Fig. 4.

The steel boiler together with a double feed indirect hot water storage cylinder to BS:1566 part 1 should be used in most situations, unless the appliance is to be fitted in a soft water area in which case the stainless steel boiler may be used with a direct hot water cylinder.

All pipework in the primary circuit must be 28mm diameter and the flow pipe must rise continuously from the boiler to the open vent.

If an indirect cylinder is used then the primary circuit should be filled with a suitable inhibitor to prevent the build up of scale and corrosion.

## FITTING THE OPTIONAL ADD-IN BOILER

The boiler replaces the rear firebrick. On the Country 8 the boiler also replaces the throat plate, on the Country 12 a special throat plate, (part no. 010/BV35), is required.

Before fitting the boiler, remove the front firebars, the side and back fire plates, the throat plate and the rear

firebrick. Knock out the knock-outs for the boiler tappings in the back of the firebox.

Remove the backnuts and fibre washers from the boiler tappings and fit the boiler into the appliance. Place the fibre washers over the tappings on the outside of the appliance and fit the backnuts, ensuring that the boiler is held tightly against the rear inside face of the appliance and that the top edge of the boiler is level or runs uphill to the flow tapping.

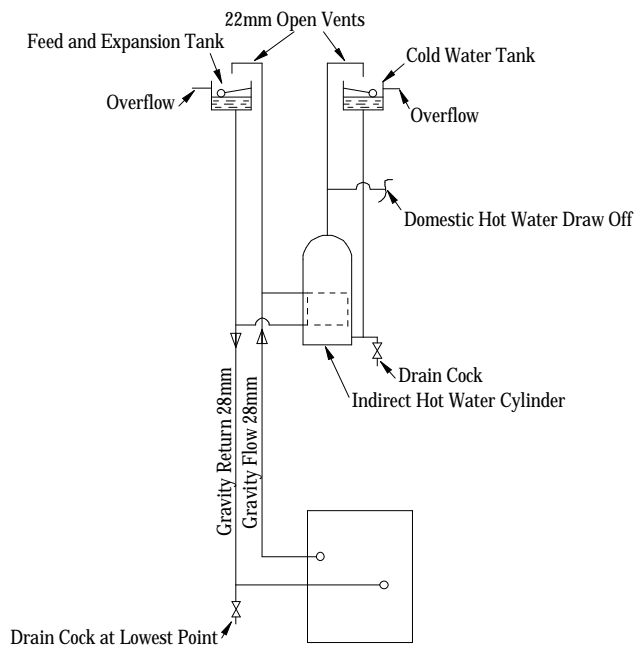
Gaps between the boiler and the firebricks should be filled with fire cement. Replace the back fireplate, the side fireplates and the front firebar. On the Country 12, fit the new throat plate.

Connect the boiler to the heating system ensuring that the flow pipe rises from the boiler. Fill the system with water and check for leaks.

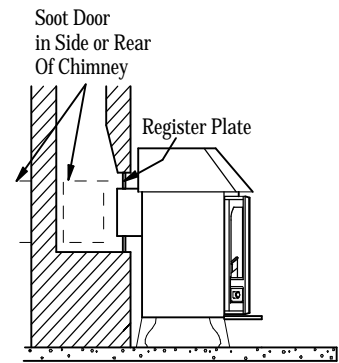
## CONNECTIONS TO FLUES

There are several ways of connecting the stove to the flue. These are illustrated in figures 5 to 8.

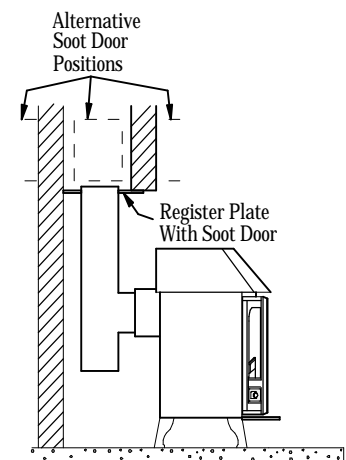
If the vertical rear flue connector is used and no boiler is fitted then the



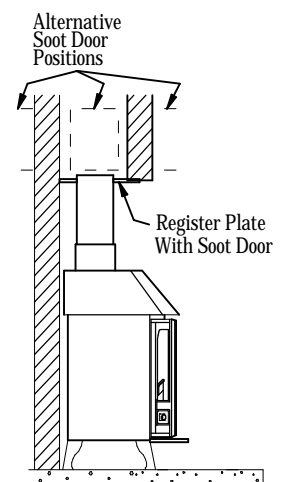
**Fig. 4. Typical Gravity Hot Water System**



**Fig 5. Vertical Register Plate  
With Bricked Up Fireplace**

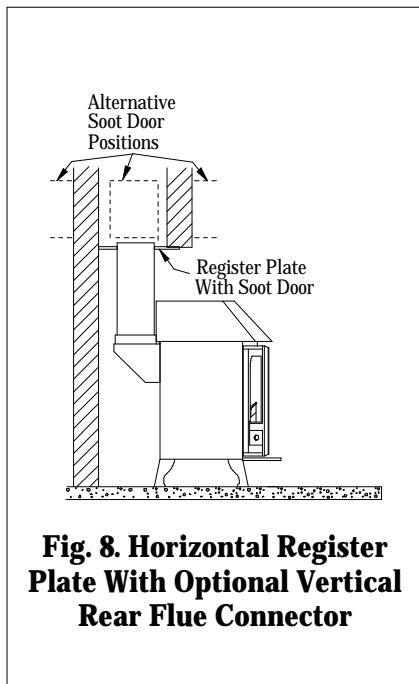


**Fig. 6. Horizontal Register Plate  
With Rear Flue Connection**



**Fig. 7. Horizontal Register Plate  
With Top Flue Connection**





**Fig. 8. Horizontal Register Plate With Optional Vertical Rear Flue Connector**

chimney may be swept through the appliance.

Horizontal lengths of flue must be kept to a minimum and should not be more than 150mm (6 inches) long. The sealing face of the flue collar should be coated with fire cement before fixing to the body of the stove using the two screws provided. The blanking plate must be removed, sealed with fire cement and refitted, care being taken to ensure that the fold on the blanking plate is in line with the lugs on the firebox as shown in Fig. 9. Ensure that the clamping plate does not prevent the throat plate from seating correctly. All flue connections must be well sealed. Ensure that the flat top or canopy is securely bolted to the body of the stove.

## SOOT DOORS

It is possible to pass a 16 inch diameter sweeps brush through the appliance but in most back outlet installations it will be necessary to have a soot door to enable the chimney to be swept. This may either be in the actual brickwork of the

chimney or in the register plate. Various types and positions of soot doors are shown in figures 5 to 8.

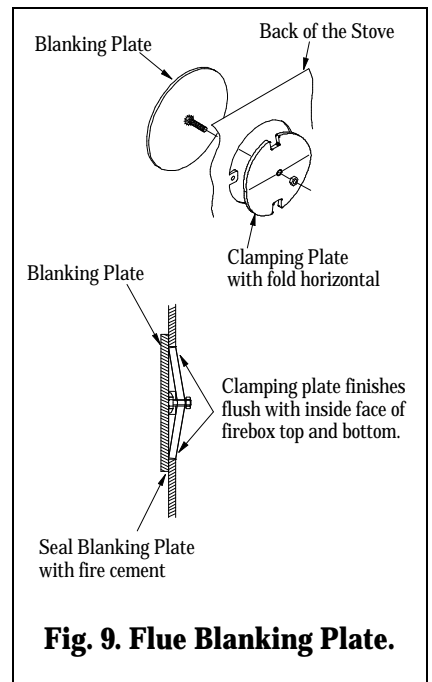
## PRE LIGHTING CHECK

Before initial lighting the following points should be checked :-

1. The bottom grate bars must all be fitted and should move freely and easily when the riddling mechanism is operated.
2. The plates round the sides and back of the grate must be in position and sitting correctly.
3. The throat plate must be fitted in the roof of the appliance and should be checked to ensure that it has not become dislodged in transit. The method of location and positioning of the throat plate is shown in fig 3.
4. The top or canopy must be securely bolted to the body of the stove using the fixings provided to ensure proper sealing.

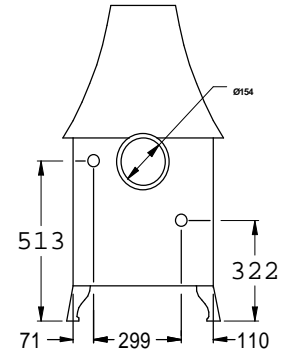
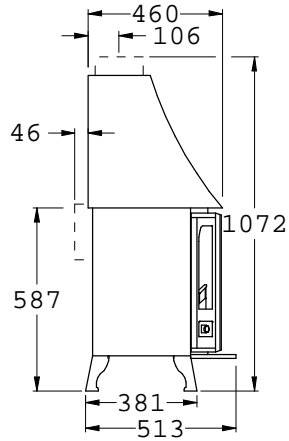
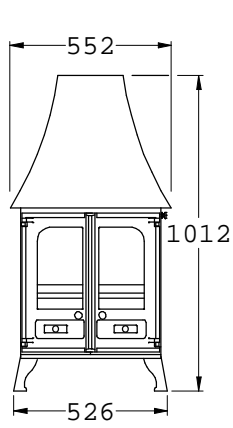
## COMMISSIONING

On completion of the installation and after allowing a suitable period of time for the fire cement and mortar to dry out, the stove should be lit and checked to ensure that smoke and fumes are taken from the appliance up the chimney and emitted safely. Also check all joints and seals. On completion of the installation and commissioning please leave the operating instructions with the customer and advise them on the use of the appliance.

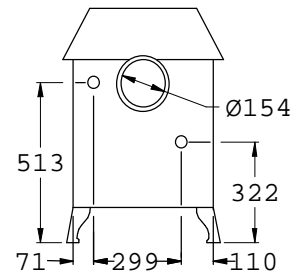
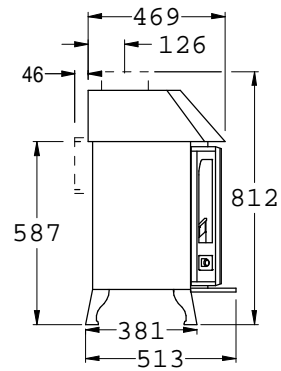
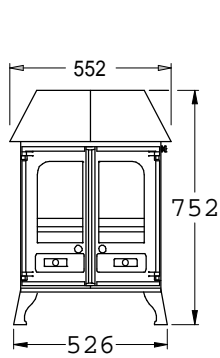


**Fig. 9. Flue Blanking Plate.**

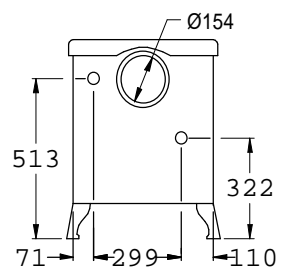
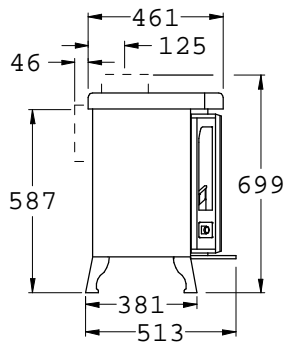
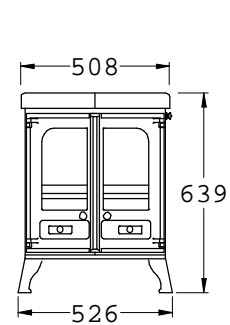
Country 8 HC  
(High Canopy)



Country 8 LC  
(Low Canopy)

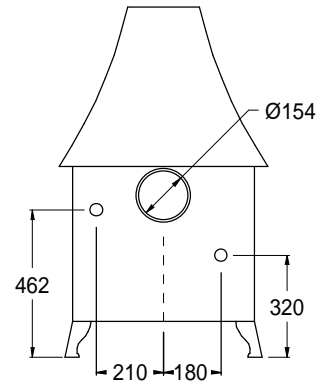
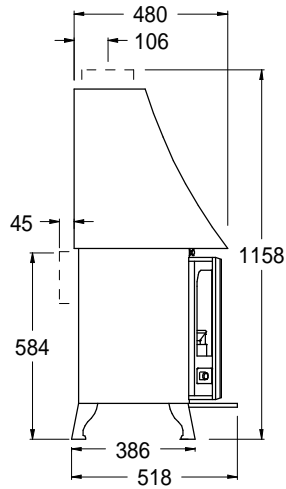
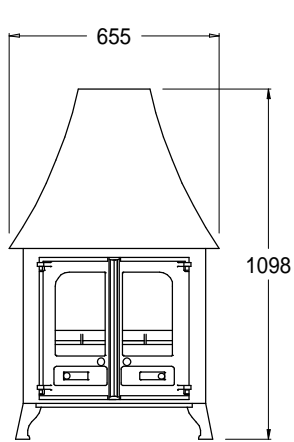


Country 8 FT  
(Flat Top)

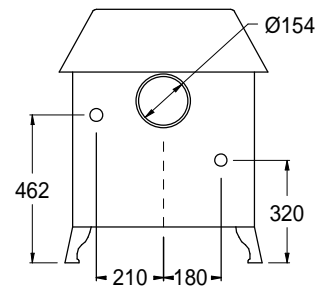
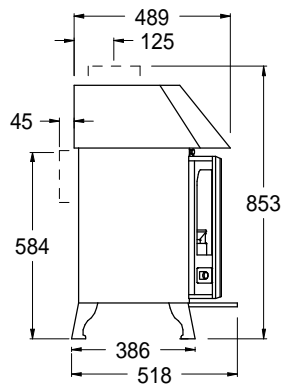
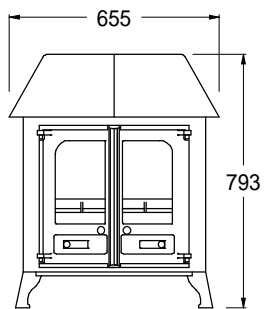


**Country 8 MkII Dimensions**  
(All dimensions are in mm)

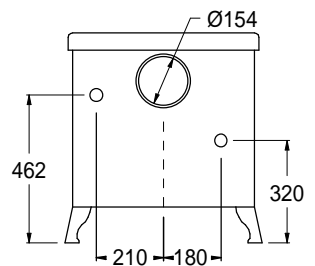
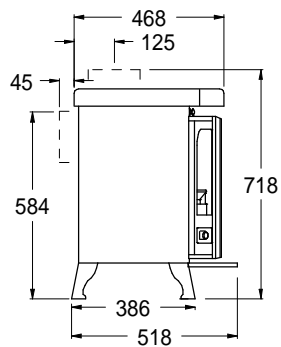
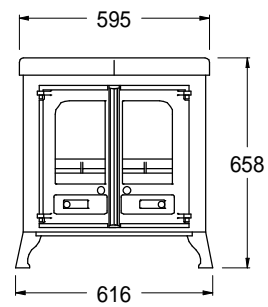
Country 12 HC  
(High Canopy)



Country 12 LC  
(Low Canopy)



Country 12 FT  
(Flat Top)



**Country 12 MkII Dimensions**  
(All dimensions are in mm)