



Eden HE

HIGH EFFICIENCY INSET ROOM HEATER

Installation, Maintenance & User Instructions

Hand these instructions to the user

Model No's BHVG**RN is for use on Natural Gas (G20) at a supply pressure of 20 mbar in G.B. / I.E.

Model No's BHVG**RP is for use on Propane Gas (G31) at a supply pressure of 37 mbar in G.B. / I.E.

** Denotes trim & colour variant

CONTENTS

	PAGE
Section 1 Information and Requirements	
1.0 Appliance information	3
1.1 Conditions of installation	4
1.2 Flue & Chimney Suitability	4
1.3 Shelf position	5
1.4 Hearths	5
1.5 Efficiency Declaration	5
Section 2 Installation of Fire	
2.1 Unpacking the combustion chamber	6
2.2 Preparing the combustion chamber opening (In studded wall)	7
2.3 Preparing the combustion chamber opening (In chimney breast)	8-9
2.4 Securing the fire to the opening	10
2.5 Installation of the gas supply	11
2.6 Making the electrical connection	12
2.7 Removal & re-fitting of the glass panel	13-14
2.8 Removing the burner assembly	15-17
2.9 Finishing the product aperture / fitting the plaster frame	18
Section 3 Assembling Fuel Bed and Commissioning	
3.1A Fitting the fuel bed logset	19-23
3.1B Fitting the fuel bed pebbles set	24
3.2 Lighting the appliance	25-29
3.3 Checking for clearance of combustion products	29-30
3.4 Removal / Re-fitting of the efficiency baffle	30
3.5 Fitting the handset wall bracket	30
Section 4 Maintenance	
4.1 Removal of the burner assembly	31
4.2 Removal of the gas control valve	31-32
4.3 Removal of the ultrasonic reciever	32
4.4 Removal of the pilot assembly	32
4.5 Removal / Replacement of the convection fan / thermal switch	32
4.6 Removal / Replacement of the handset battery	33
4.7 Checking for flue debris	33
Section 5 User Instructions	
5.1 Installation Information / about the Eden HE	34-35
5.2 Lighting the appliance	36-39
5.3 Important safety information	40
5.4 Cleaning & removing / replacing the glass panel	41-43
5.5A Removal & re-fitting the fuel-bed logset	44-48
5.5B Removal & re-fitting the pebble fuel-bed pebble set	49

Model numbers **BHVG**RN & BHVG**RP** are manufactured by:-

BFM Europe Ltd. Trentham Lakes, Stoke-on-Trent, Staffordshire, ST4 4TJ

SECTION 1 INFORMATION AND REQUIREMENTS

1.0 APPLIANCE INFORMATION

Main injector : (1 off)	Stereomatic Cat 82 – size 2.05 (NG) Stereomatic Cat 82 – size 1.31 (LPG)
Pilot Type :	NG - Seagas P5-29D LPG - Seagas P5-30LP
Max. Gross Heat Input :	6.9 kW
Min. Gross Heat Input :	2.0 kW
Cold Inlet Pressure :	G20 20.0+/-1.0 mbar (8.0 +/- 0.4 in w.g.) G31 37.0+/-1.0 mbar (14.8 +/- 0.4 in w.g.)
Ignition :	Integral to gas valve
Electrode Spark Gap :	4.0mm
Packed Weight Combustion Chamber :	66.0 kg
Supply Voltage :	230V a.c.
Supply Frequency :	50Hz
Supply Fuse :	3 Amp to BS 1362
Electrical Supply Required	230v AC, 50Hz

Fig. 1

Top View of Combustion Chamber

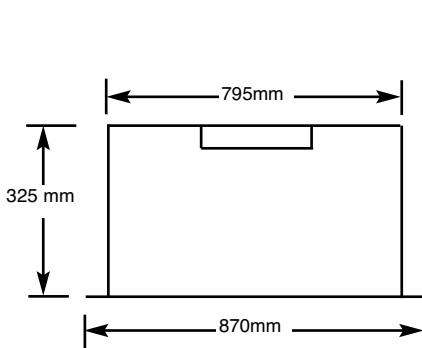
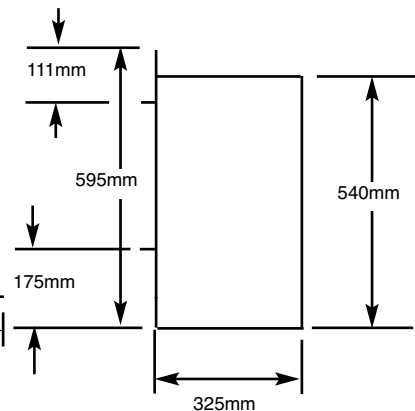

Fig. 2

Side View of Combustion Chamber



INSTALLATION REQUIREMENTS

1.1 CONDITIONS OF INSTALLATION

It is the law that all gas appliances are installed only by a GAS SAFE Registered Installer, in accordance with these installation instructions and the Gas Safety (Installation and Use) Regulations 1998 as amended. Failure to install appliances correctly could lead to prosecution. It is in your own interest and that of safety to comply with the law. The installation must also be in accordance with all relevant parts of the Local and National Building Regulations where appropriate, the Building Regulations (Scotland Consolidation) issued by the Scottish Development Department, and all applicable requirements of the following British Standard Code of Practice.

1. BS 5871 Part 2 Installation of Inset Live Fuel Effect Gas Fires
2. BS 6891 Installation of Gas Pipework
3. BS 5440 Parts 1 & 2 Installation of Flues and Ventilation
4. BS 1251 Open fire place components
5. BS 715 / BS EN 1856-2 Metal flue pipes for gas appliances
6. BS EN 1858 Clay Flue Blocks and Terminals
7. IS 813 : Domestic Gas Installation (Republic of Ireland)

No purpose made additional ventilation is normally required for this appliance, when installed in G.B. When installing in I.E. please consult document I.S. 813 : Domestic Gas Installation, which is issued by the National Standards Authority of Ireland. If installing in Northern Ireland, please consult local building regulations. Any purpose made ventilation must be checked periodically to ensure that it is free from obstruction.

1.2 FLUE AND CHIMNEY SUITABILITY

This appliance is designed for use with conventional brick built or lined chimneys and fabricated flues and metal flue boxes conforming to BS 715 / BS EN 1856-2. All flues must conform to the following minimum dimensions.

Minimum diameter of circular flues	125 mm
Minimum effective height of all flue types	4 metres

Safe clearance of products must always be checked by carrying out a smoke match test as described in section 3.3

1.3 SHELF POSITION

The fire may be fitted below a combustible shelf providing there is a minimum distance of 300mm above the top of the fire and the shelf does not project more than 150mm. If the shelf overhangs more than 150mm the distance between the fire and the shelf must be increased by 15mm for every 25mm of additional overhang over 150mm.

1.4 HEARTHES

This appliance does not require the fitting of a hearth that projects in front of it when installed into a recess in either an existing chimney breast or a stud wall, providing the appliance is installed a minimum of 225mm above the floor level. The appliance must however stand on a non-combustible base that is a minimum thickness of 12mm

1.5 APPLIANCE EFFICIENCY DECLARATION

The efficiency of this appliance has been measured as specified in BS EN 7977-1 : 2002 and the result is 75%.

The gross calorific value of the fuel has been used for this efficiency calculation. The test data from which it has been calculated has been certified by GL Industrial Services.

The efficiency value may be used in the UK Government's Standard Assessment Procedure (SAP) for energy rating of dwellings.

SECTION 2 INSTALLATION OF FIRE

2.1 UNPACKING THE COMBUSTION CHAMBER

Carefully lift the combustion chamber out of the carton. Remove the loose item packaging carefully from the pack. Check the contents as listed :-

DO NOT UNDER ANY CIRCUMSTANCES USE THIS APPLIANCE IF THE GLASS PANEL IS BROKEN OR NOT SECURELY FIXED TO THE FIREBOX.

Packing Check List

- | | | |
|--------|---|----------------------------|
| 1 off | Combustion Chamber & Glass Assembly | |
| 1 off | Boxed ceramic fuel-bed set (packed inside combustion chamber) | |
| 1 off | Installation instruction / user manual | |
| 1 off | Plastering frame | |
| 11 off | Thermostatic remote handset | |
| 1 off | Loose items pack – containing :- | |
| | | 4 off No. 12 x 40mm Screws |
| | | 4 off Rawlplugs |
| | | 1 off 9V Battery |
| | | 1 off Glass clamp |
| | | 1 off Handset bracket |

PLEASE NOTE : Due to the high level of heat produced by this product we recommend that Plasma / LCD televisions are not placed in close proximity to this product.

2.2 PREPARATION OF THE COMBUSTION CHAMBER OPENING (INTO STUDDED WALL) USING A 125MM OR 175MM FLUE LINER.

All combustible parts of the studwork must be set at the distances as shown below in Fig. 3 & 4. For installation into such applications a flue box with 125mm flue pipe adaptor is available to purchase as a cost option extra, please order part number 1130-127730, from your local BFM fires stockist.

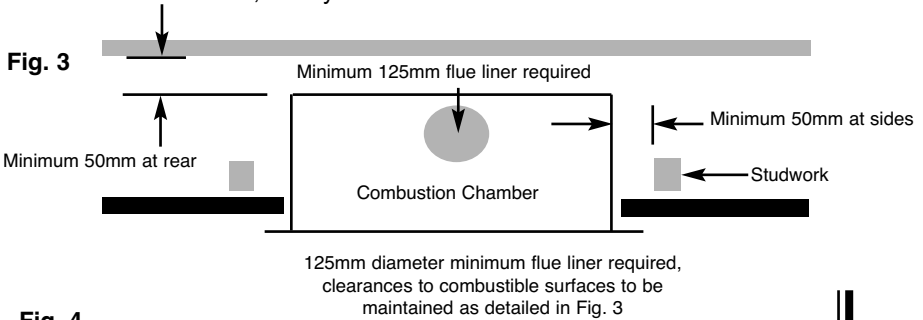
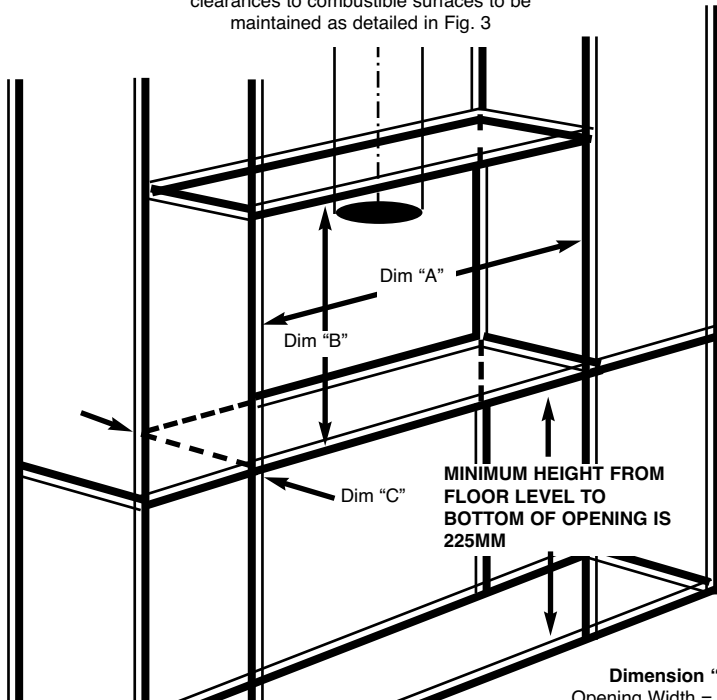

Fig. 4



PLEASE NOTE : For the front face of the studwork a non combustible board such as "Versa Tecbor" should be used in a double 12mm thickness. "Versa Tecbor" board is available from Euroform Products Ltd, Tel : (01925) 860999, www.euroform.co.uk

Dimension "A"
Opening Width = 835mm

Dimension "B"
Opening Height = 560mm to 570mm

Dimension "C"
Minimum Depth 340mm

2.3 PREPARATION OF THE COMBUSTION CHAMBER OPENING (INTO EXISTING CHIMNEY BREAST)

An opening should be constructed to the following dimensions in the existing chimney breast. See fig. 5 below

Fig. 5

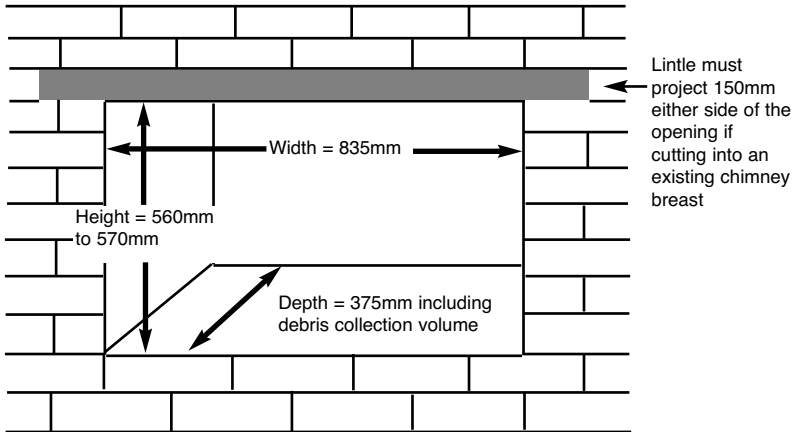

PLEASE NOTE : The opening size as detailed above will require reducing in size to the product aperture and finishing in a high temperature plaster finish as detailed in section 2.9

CHECK ANY LOAD BEARING STRUCTURAL ITEMS ARE NOT AFFECTED BY THE INSTALLATION OF THE PRODUCT. SEE FIG 6 OVERPAGE.

If the flue requires lining, an optional extra flue connection plate assembly can be ordered to assist with the flue connection. This assembly can be obtained from your local BFM Fires stockist, please quote part number 1130-127120. Included with this assembly are fitting instructions.

Fig. 6

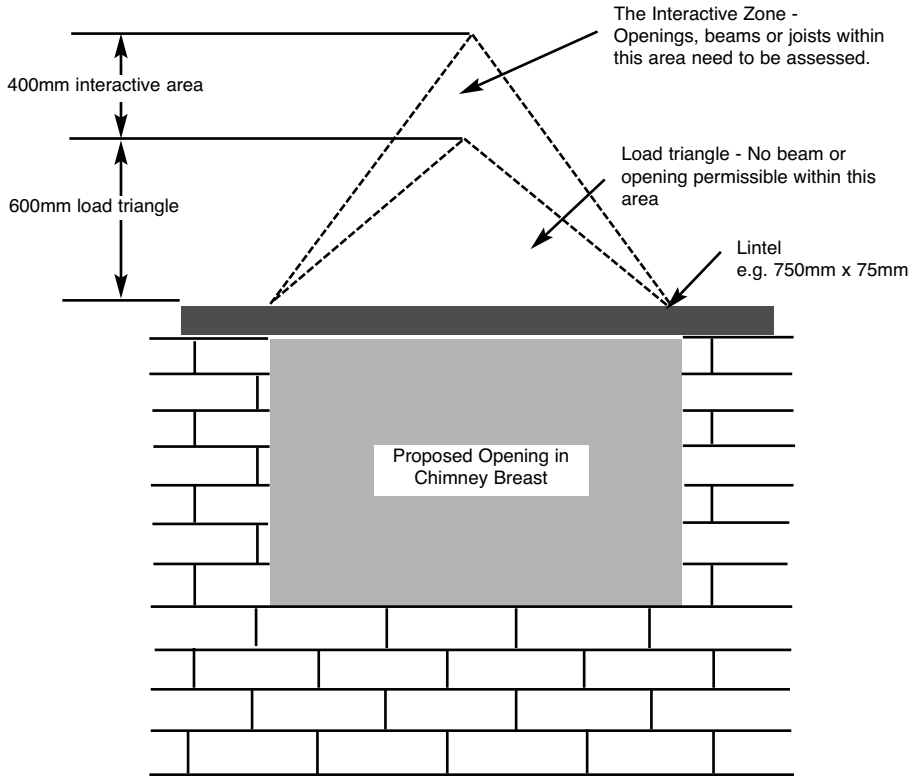

The opening needs to be sufficient to accommodate the combustion chamber. To support the wall above the opening, a suitable lintel must be inserted across the top of the opening. The lintel could be either pre-cast concrete or steel - Catnic CN52 or CN 46 could be used, depending upon the inner wall thickness. Before proceeding with the installation of the fire, an assessment of the area immediately above the fire is required, see Fig. 6 above. If there is no existing openings within either triangle, proceed with forming the opening. However, if opening or beams occur within either triangle, then you should seek specialist advice from a structural engineer or consider relocating the proposed position of the firebox.

2.4 SECURING THE COMBUSTION CHAMBER TO THE OPENING

- a) The combustion chamber must be secured to the opening via the four off screw and rawlplugs provided. Fig. 7 below shows the hole centres in the mounting flanges of the combustion chamber.

Fig. 7

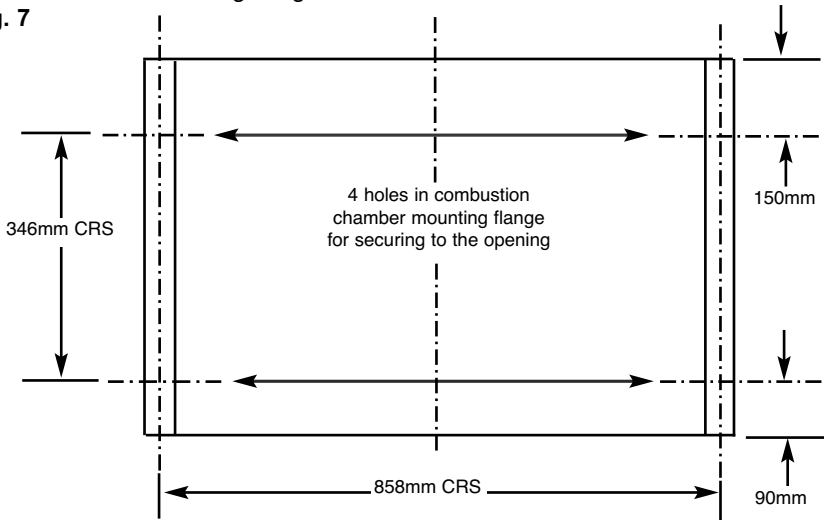

- b) DO NOT SECURE THE COMBUSTION CHAMBER INTO THE OPENING AT THIS POINT AS ACCESS WILL STILL BE REQUIRED TO RUN THE GAS SUPPLY PIPEWORK AS DETAILED IN SECTION 2.5

Fig. 8

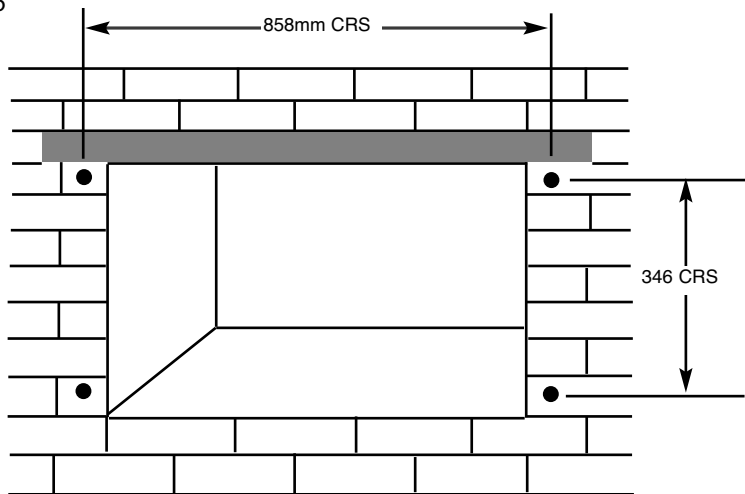

2.5 INSTALLATION OF THE GAS SUPPLY (INTO STUDDED WALL OR EXISTING CHIMNEY BREAST)

Before installing the combustion chamber, decide from which side or if a rear connection to the gas supply is required. Plan the pipe run to enter from the rear or below the firebox from the left, right or rear and connect to the inlet elbow. See Fig. 9, 10 & 11 below. The gas connection is located at the front right hand side of the fire. **Note : Before breaking into the gas supply a gas tightness test should be carried out to establish that the existing pipework is sound.**

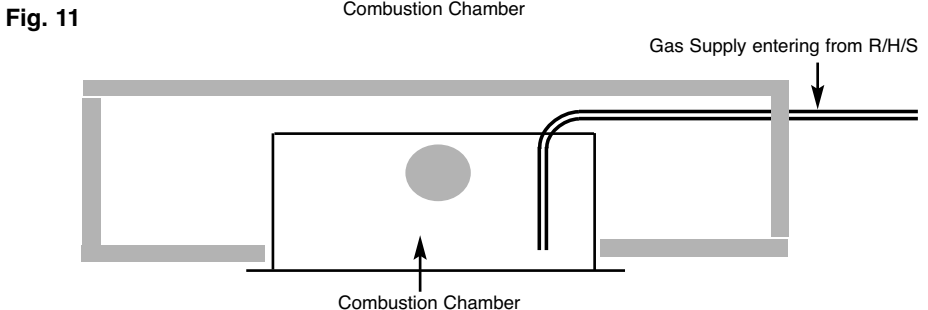
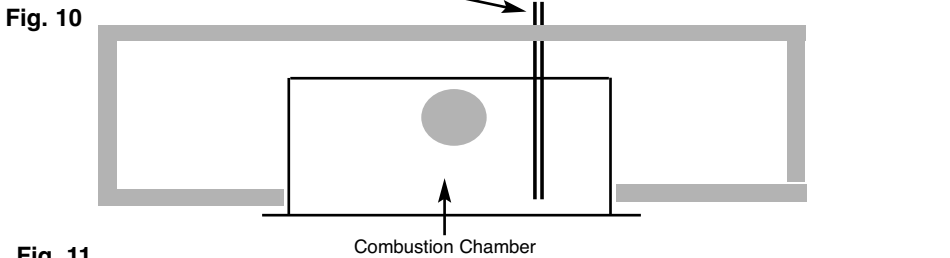
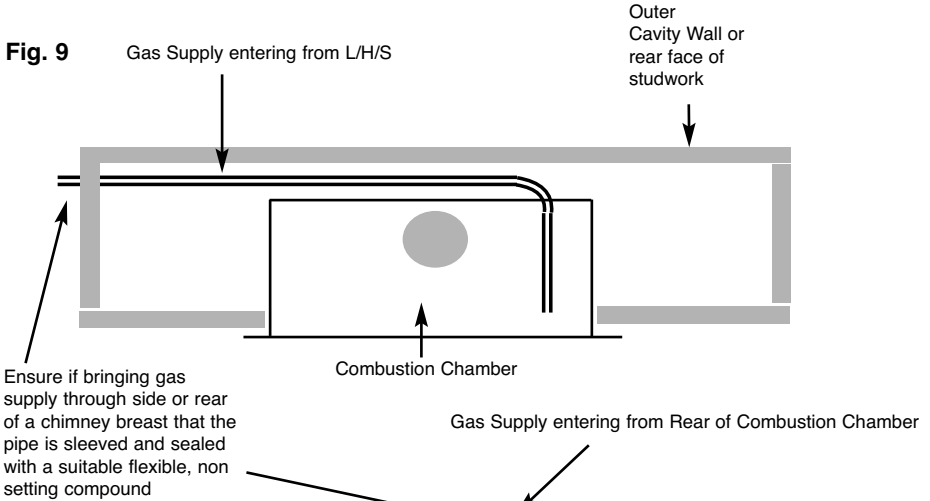

2.6 MAKING THE ELECTRICAL CONNECTION.

WARNING : THIS APPLIANCE MUST BE EARTHED AND SHOULD BE PREFERABLY CONNECTED VIA A 3 AMP FIXED FUSED SPUR WITH A MINIMUM CONTACT SEPARATION OF 3MM.

IT MAY HOWEVER BE CONNECTED TO A 3 PIN PLUG TO BS 5733, THAT IS FITTED WITH A 3 AMP FUSE TO BS 1362.

- a) The product is supplied with a mains cable and 3 pin plug fitted. The mains cable will exit the combustion chamber from the rear left hand side (viewed from the front), through the grommet.
- b) Plug the mains cable supplied into a suitable socket in close proximity to the appliance or remove the plug and wire into a fixed fused spur.

2.7 REMOVING / RE-FITTING THE GLASS PANEL

- a) To remove the glass frame, the glass clamp as supplied in the loose items pack will be required. Secure the clamp to the glass panel as shown below in Fig. 12

Fig. 12

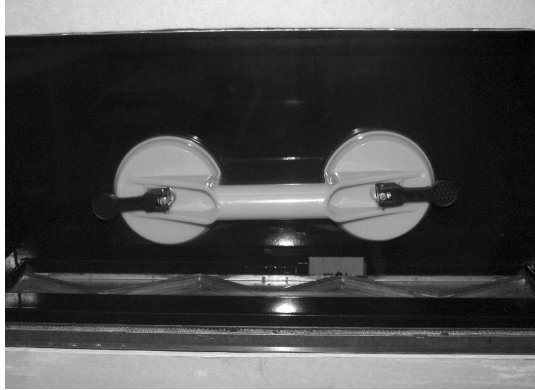

- b) Remove the front grill by removing the 2 off retaining screws from the upturned tabs, 1 off at each end of the trim. Remove the side trims by simply lifting clear (they are retained by magnets). See Fig. 13 below.

Fig. 13

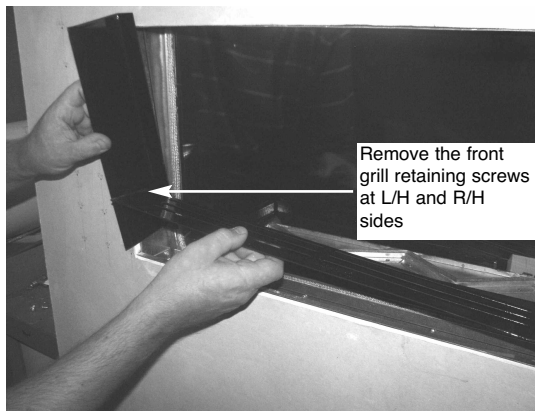

NOTE : Always ensure that a consistent seal between the combustion chamber and the glass frame is achieved when replacing the glass panel.

- c) Remove the 5 off securing screws and glass panel retaining bracket that are located on the top underside face of the combustion chamber behind the canopy. See Fig. 14 below.

Fig. 14

Glass Panel Retaining Bracket, secured by 5 off screws

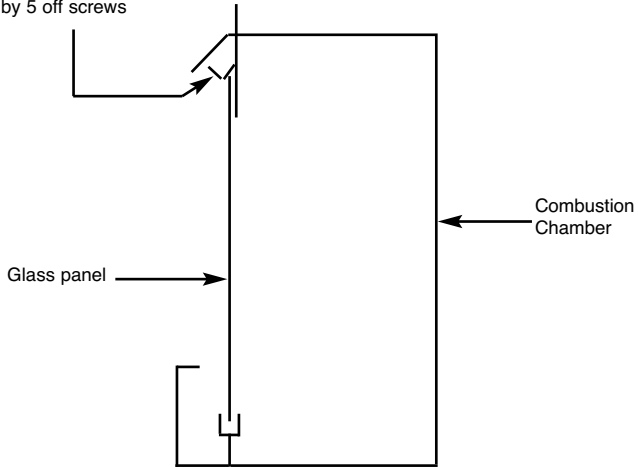

- c) Lift the glass panel vertically to release from the bottom retaining channel and then tilt forwards as shown below in Fig. 15 / 16 to release.

Fig. 15

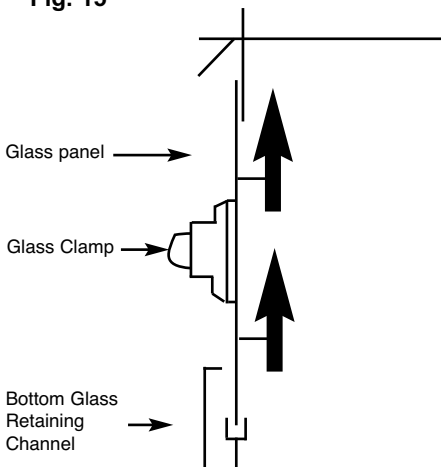
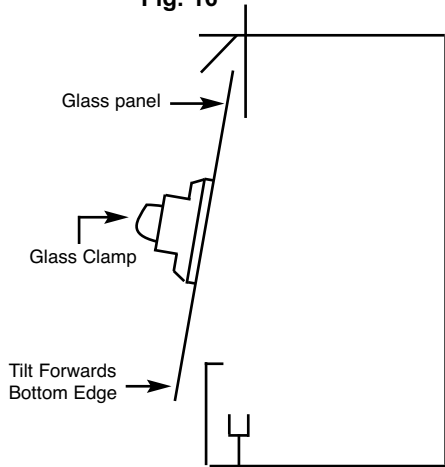

Fig. 16



2.8 REMOVING THE BURNER ASSEMBLY

- a) Lift the burner tray cover vertically clear as shown below in Fig. 17 and store in a safe place.

Fig. 17

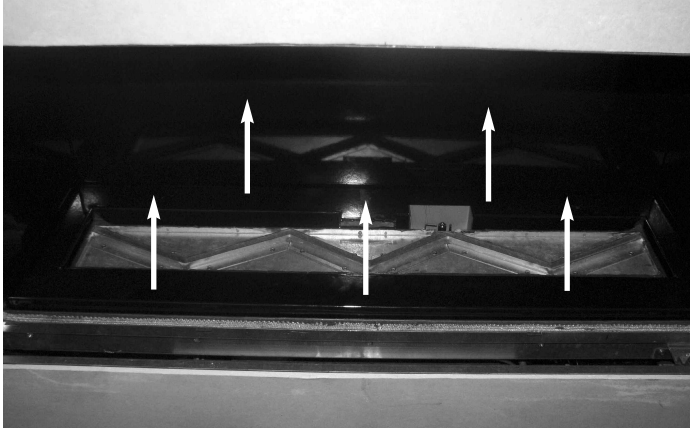

- b) This will allow access to the 6 off burner retaining screws, 3 off at the front of the burner and 3 off at the rear as shown below in Fig. 18

Fig. 18

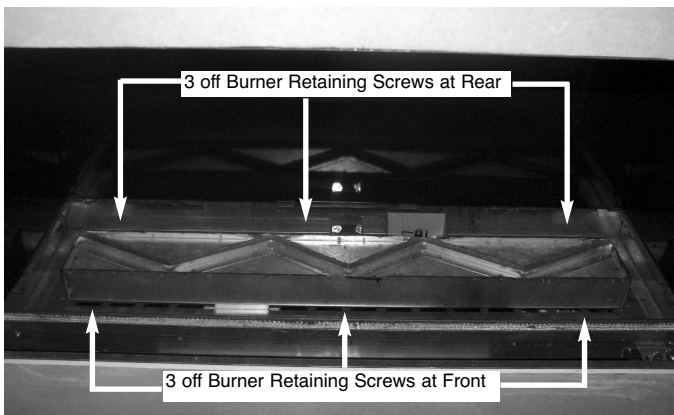

- c) With the 6 off burner screws removed, remove the isolation switch from it's retaining bracket at the front right hand side. This is achieved by lifting the switch clear from the bracket as shown below in Fig. 19

Fig. 19

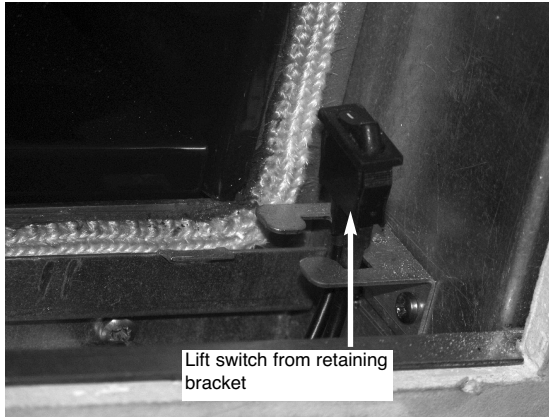

- d) Disconnect the burner gas supply pipe from the inlet elbow at the front right hand side by unscrewing the nut as shown below in Fig. 20

Fig. 20

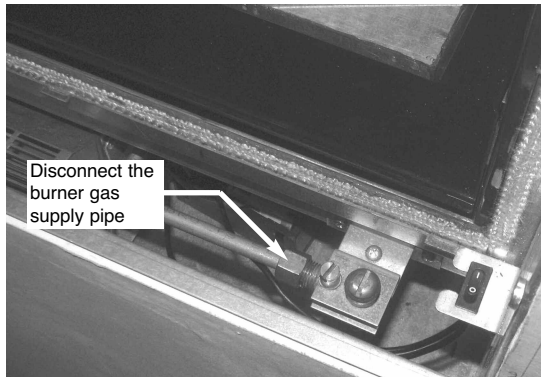

- e) The burner can then be lifted, tilted forwards and removed from the combustion chamber as shown below in Fig. 21

Fig. 21

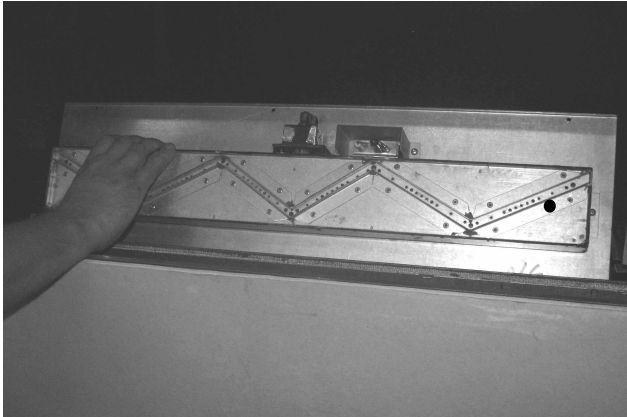

- f) Make the gas connection to the inlet elbow as prepared in section 2.5
Before making the final gas connection, thoroughly purge the gas supply pipework to remove all foreign matter, otherwise serious damage may be caused to the gas control valve on the fire.
Failure to purge the gas supply will invalidate the guarantee.
- g) Replace the burner unit in reverse order and re-connect the gas supply pipe.
- h) Replace the isolation switch into it's retaining bracket in reverse order, taking care not to damage the wiring.
- i) Remove the pressure test point screw from the inlet elbow and fit a manometer.
- j) Turn on the main gas supply and carry out a gas tightness test.
- k) Turn on the electrical supply to the appliance via the fixed fused spur or plug.
- l) Finish the surface covering below the opening as shown in section 2.8
- m) Fit the ceramics as shown in section 3.1A/B, replace the burner tray cover, glass panel and glass panel securing bracket / 5 off screws. Replace the side trims which are retained by magnets and the front grill, then proceed to section 3.2 (lighting the appliance).

2.9 FINISHING OF THE PRODUCT APERTURE / FITTING THE PLASTERING FRAME

- a) The area below around the appliance will require a high temperature plaster finish around the appliance due to the high heat output level of the product, see Fig. 22. A plastering frame is supplied with the product to assist in obtaining this finished surface. To prevent plaster cracking and discolouration, finish the 600mm area above and the 300mm area at the side and below with a high temperature plaster finish as follows :-

Fig. 22

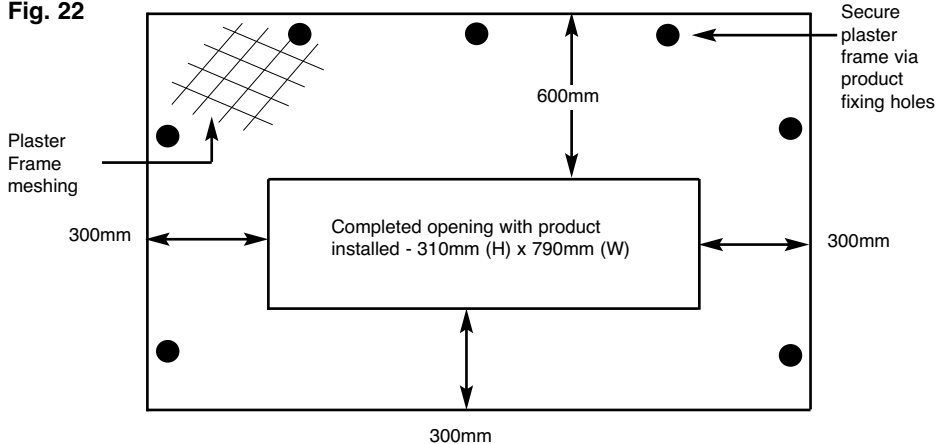

- b) The high temperature plaster should be applied over a heat proof screed to the manufacturers instructions (see below for manufacturers contact details) and left to dry for a minimum of 3 days.
- c) Supplier's contact details for heat proof screed & plaster are as follows :-

Vitcas Ltd.
8 Bonville Road
Brislington
Bristol
BS4 5NZ
Tel : 0117 911 7895
www.vitcas.com
info@vitcas.com

or The Greener Company
The Old Canteen
Rosemount Works
Huddersfield Road
Elland
HX5 0EE
Tel : 01925 750290
www.thegreenercompany.com

SECTION 3 INSTALLATION OF FIRE

3.1 A FITTING THE FUEL-BED LOGSET

IF FITTING THE PRODUCT WITH THE PEBBLE FUELBED, PLEASE PROCEED TO SECTION 3.1B

- a) The vermiculite material should then be first layed around the burner tray as shown below in Fig. 23, resulting in an even layer.

Fig. 23



- b) Place Log "1" at the left hand side of the burner tray fitting the holes in the bottom face of the log onto the 2 off location pegs as shown below in Fig. 24

Fig. 24



- c) Place Log “2” at the right hand side centre of the burner tray fitting the hole in the bottom face of the log onto the single location peg as shown below in Fig. 25

Fig. 25

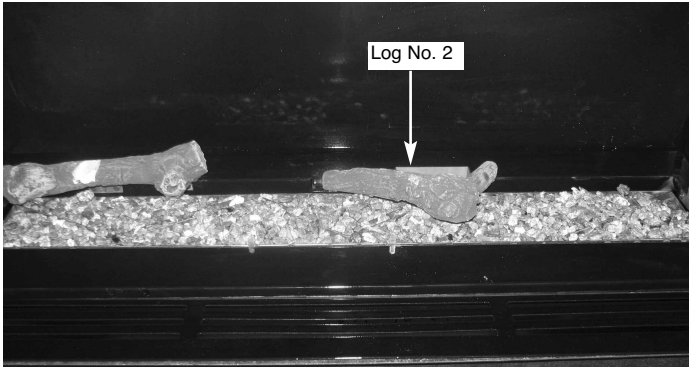

- d) Place Log “3” at the right hand side of the burner tray fitting the hole in the bottom face of the log onto the single location peg as shown below in Fig. 26

Fig. 26



- d) Place Log “4” at the centre of the burner tray fitting the holes in the bottom face of the log onto the 2 off location pegs as shown below in Fig. 27

Fig. 27

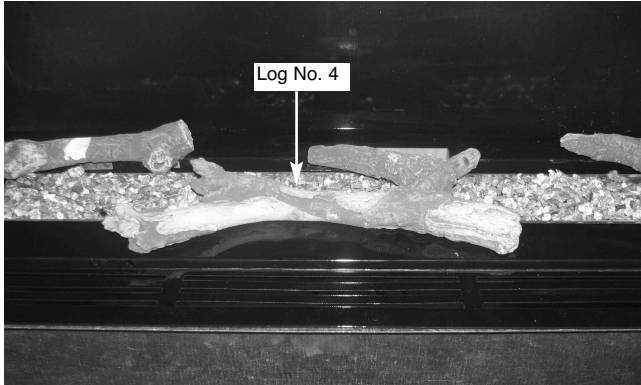

- e) Place Log “5” at the right hand side of the burner tray locating in the groove of Log “3” as shown below in Fig. 28

Fig. 28

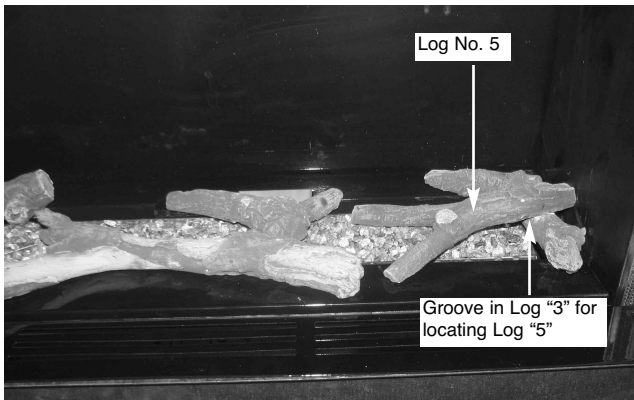

- f) Place Log “6” at the left hand side of the burner tray locating in the groove of Log “1” as shown below in Fig. 29

Fig. 29

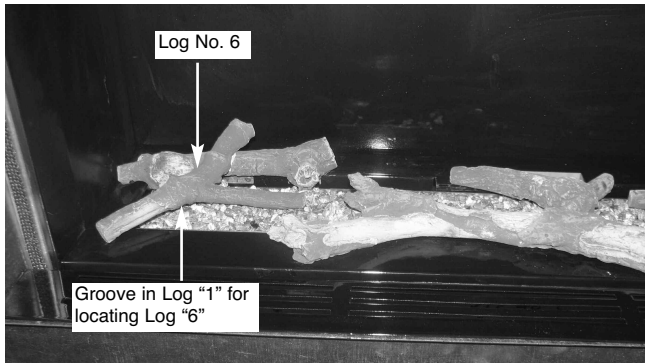

- g) Place Log “7” to the left hand centre side of the burner tray locating on the branch of Log “1” as shown below in Fig. 30

Fig. 30

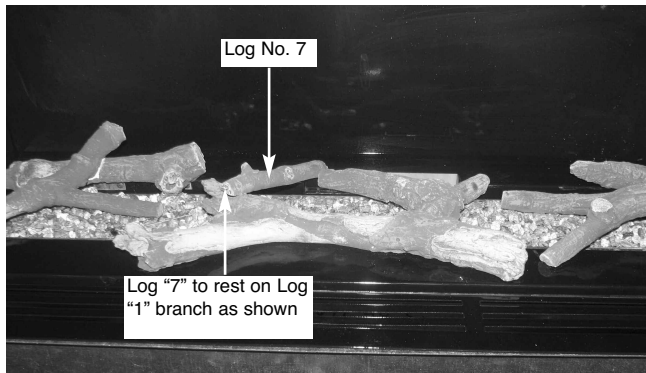

- h) If required, fit the glow fibre material over the flame ports. To do this, separate into short strands and place randomly over the flame porting area as shown below in Fig. 31. **This material is only supplied to improve flame aesthetics and is optional to install.**

Fig. 31



- g) Refit the glass panel as described in section 2.7, then light the appliance as described as in section 3.2

IMPORTANT NOTE : PLEASE ENSURE THAT WHEN COMMISSIONING THE FIRE THE FLAME PATTERN IS EVEN ACROSS THE WIDTH OF THE BURNER. IF AN UNEVEN FLAME PATTERN IS FOUND THEN RELAY THE QUANTITY VERMICULITE TO ACHIEVE AN EVEN FLAME PATTERN.

Warning : Use only the logs supplied with the fire. When replacing the logs remove the old logs and discard them. Fit a complete set of logs of the correct type. Do not fit additional logs or any logs other than a genuine replacement set.

This appliance does not contain any component manufactured from asbestos or asbestos related products.

3.1 B FITTING THE FUEL-BED PEBBLES

- a) Remove the log retaining brackets (which are held in place by self tapping screws) from the fuel-bed support plate and retain them in a safe place. Fold the log retaining bracket mounted to the burner to the flat position. Fit the pebbles to the burner tray as shown below in Fig. 32, do not fill the flame ports in the burner with pebbles.

Fig. 32



- b) Fit the vermiculite material into the burner ports as shown below in Fig. 33. **This material must be fitted in an even layer to ensure correct operation of the fire.**

Fig. 33

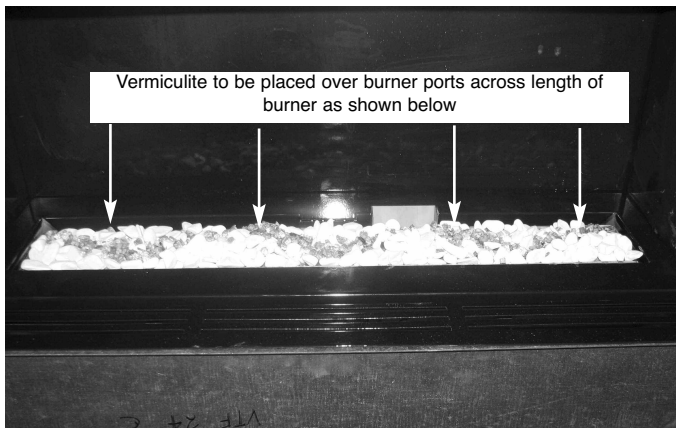

- c) If required, fit the embaglow material over the flame ports. To do this, separate into short strands and place randomly over the flame porting area as shown on previous page in Fig. 31. **This material is only supplied to improve flame aesthetics and is optional to install.**
- d) Refit the glass panel as described in section 2.7, then light the appliance as described as in section 3.2

3.2 LIGHTING THE APPLIANCE

IMPORTANT : IF THE BURNER IS EXTINGUISHED FOR ANY REASON YOU MUST ENSURE THAT YOU WAIT A FULL FIVE MINUTES BEFORE ATTEMPTING TO RE-LIGHT THE FIRE.

The BFM Fires Eden HE is controlled by the remote handset supplied with the fire. Ensure the 9V battery as supplied in the loose items pack has been fitted to the handset before attempting to light it. There are 3 modes of operation of the product, “MANUAL mode”, “TEMPERATURE mode” and “TIMER mode”.

3.2.1 Operation of the Fire in “MANUAL” mode

- a) Locate the ON/OFF switch on the appliance, it is situated at the right hand side in front of the glass panel. Ensure that the on / off switch on the valve is in the “ON” (1) position as shown below in Fig. 34

Fig. 34

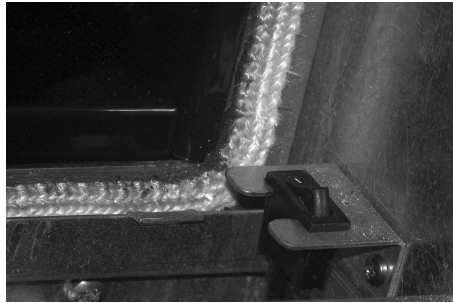

- b) The remote handset is now used to control all functions of the fire. To light the fire, press the “UP” arrow and and “OFF” button simultaneously, as shown on Fig. 35 below. You will hear a click and the fire begins a 30 second ignition process. The pilot and main burner will light. The appliance is now in “MANUAL mode” which will be shown via the “MAN” graphic on the display of the handset as shown below in Fig. 35

Fig. 35

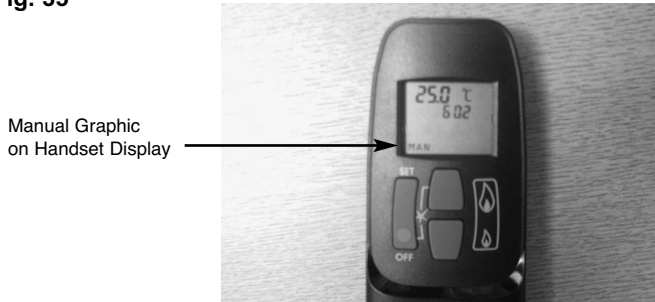

- c) With the product in “MANUAL” mode the fire can now be switched between HIGH rate heat input and LOW rate heat input by pressing the “DOWN” arrow on the handset. To reduce the flame height of the main burner incrementally, press the arrow momentarily. To reduce the heat input directly down to the minimum level, press the “SMALL” flame arrow on the handset twice, “LO” will be displayed. NOTE : The flame will go to HIGH rate heat input before going to designated LOW rate heat input. To return back to HIGH rate heat input press the “LARGE” flame button twice. To put the fire in In “STANDBY MODE” (only the pilot remains lit) press and hold the “SMALL” flame arrow on the handset. See Fig. 36 below

Fig. 36

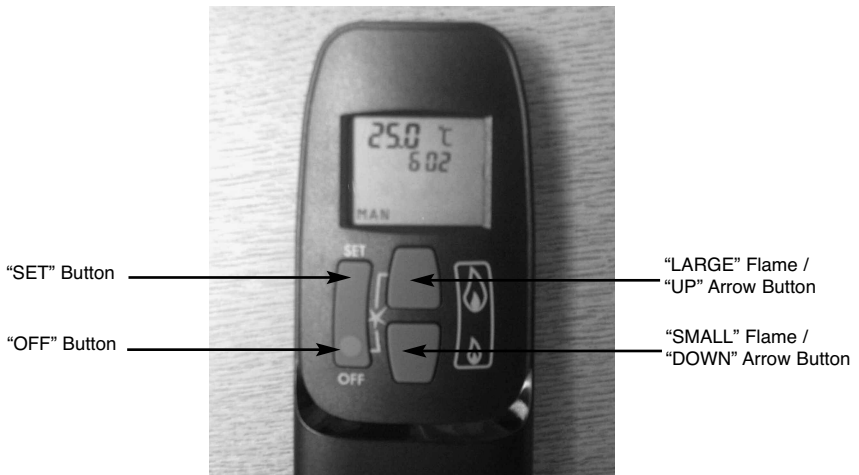

- d) To turn the fire off, press the “OFF” button, this will extinguish all flames including the pilot.

3.2.2 Operation of the Fire in “TEMPERATURE” mode

- a) In order to change the mode of operation from “MANUAL” to “TEMPERATURE”, press the “SET” button, the fire will then change to either “DAY TEMP” (Fig. 37) mode or “NIGHT TEMP” mode (Fig 38). To alternate between the 2, press the “SET” button. **The display on the handset will show the current temperature in the room.**

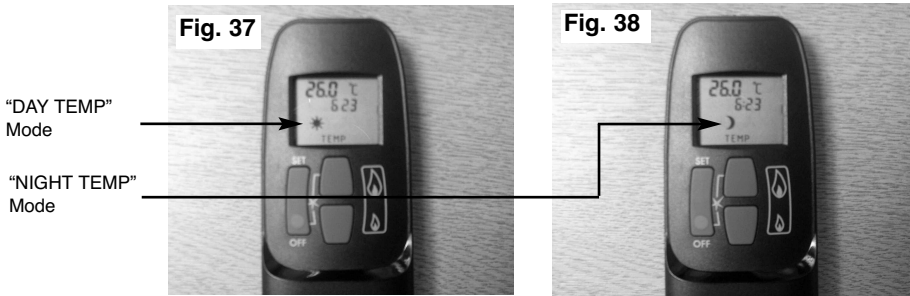

NOTE : The “SET” button allows you to alternate between all modes of operation :- “MANUAL”, “DAY TEMP”, “NIGHT TEMP”, “TIMER” and back to “MANUAL”. Alternatively, pressing either the “UP” or “DOWN” arrow allows the unit to revert to “MANUAL” mode.

- b) Within the “TEMPERATURE” mode there are options for either “DAY TEMP” or “NIGHT TEMP”. These temperatures can be set independently to allow a higher temperature to be maintained at night than during the day, or if setting the same temperature for day and night the fire will compensate for the generally cooler evening temperatures and automatically increase the heat input level accordingly.
- c) To set the temperature, ensure the handset is in “TEMPERATURE” mode and then press the “SET” button until the “TEMP” display flashes then let go. Proceed to set the desired temperature by pressing the “UP” (large flame) or “DOWN” (small flame) arrows as necessary, then press “OFF” to complete the process.
- NOTE :** Minimum temperature is 5°C, Maximum temperature is 30°C, or minimum 41F to maximum 86F when in Fahrenheit mode.
- d) Press the “OFF” button to stop the display flashing or wait to return to “TEMPERATURE” mode. **NOTE :** If you set a temperature below the current room temperature the fire will switch to standby mode (pilot burner only) until the room has cooled to the temperature you have set on the handset display.
- e) If you would like the “NIGHT TEMP” to turn the fire off then decrease the temperature until [----] is displayed.

3.2.3 Operation of the Fire in “TIMER” mode

- a) In order to change the mode of operation from “MANUAL” to “TIMER”, press the “SET” button, the fire will then alternate between the settings until the “TIMER” mode is displayed.

NOTE : The “SET” button allows you to alternate between all modes of operation :- “MANUAL”, “DAY TEMP”, “NIGHT TEMP”, “TIMER” and back to “MANUAL”. Alternatively, pressing either the “UP” or “DOWN” arrow allows the unit to revert to “MANUAL” mode.

- b) Within the “TIMER” setting mode there are two programmable settings you can make over a 24 hour period, namely P1 and P2. To set the timer, ensure the handset is in “TIMER” mode as detailed in section a) above.
- c) To set the P1 timed start setting, press and hold the “SET” button until the P1 (sun symbol is displayed as per Fig. 39 below) and the time flashes. Set the hour by pressing the “UP” (large flame) and set the minutes (in ten minute increments) by pressing the “DOWN” (small flame) as necessary, then press “OFF” button to complete the process. Repeat for the P1 (moon symbol is displayed as per Fig. 40 below) Set the hour by pressing the “UP” (large flame) and set the minutes (in ten minute increments) by pressing the “DOWN” (small flame) as necessary, then press “OFF” button to complete the process.

P1 with “Sun”
symbol
illuminated

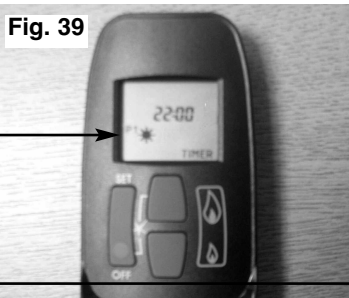

Fig. 39

P1 with “Moon”
symbol
illuminated

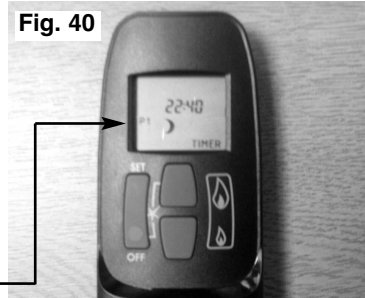

Fig. 40

- d) To set the P2 timed setting, press the “SET” button until the “TIMER” mode is displayed. Hold the “SET” button until the display flashes the current time for P1. Press the “SET” button again to scroll past the setting for P1 (sun) and P1 (moon). The time should now be flashing on the handset. Set the hour by pressing the “UP” (large flame) and set the minutes (in ten minute increments) by pressing the “DOWN” (small flame) as necessary, then press “OFF” button to complete the process.

3.2.4 Low Battery Signal

- a) When the battery in the handset needs replacing, "BATT" will be displayed on the handset.
- b) Remove the cover on the rear of the handset and replace the 9V battery as necessary.

3.2.5 To Set the Time on the Remote Handset

- a) Simultaneously press the "UP" (large flame) arrow and "DOWN" (small flame) arrow buttons on the remote handset.
- b) Press the "UP" (large flame) arrow to set the hour and the "DOWN" (small flame) arrow to set the minutes.

3.2.6 To Set the °C / 24 Hour or °F / 12 Hour Clock

- a) Press and hold the "OFF" and the "DOWN" (small flame) arrow buttons on the handset simultaneously until the display changes from °C to °F and vice versa

3.3 CHECKING FOR CLEARANCE OF COMBUSTION PRODUCTS

- a) Close all doors and windows in the room.
- b) Light the fire and allow to run for approximately 5 minutes on high position.
- c) After approximately 5 minutes hold a smoke match just inside and below the centre of the lower front canopy at the top of the fire (see Fig. 41 overpage). It is recommended that a suitable smoke match holder is used when checking for clearance of combustion products). All smoke generated should be drawn back into the flue. If slight spillage occurs or if in doubt, repeat the test after a further 5-10 minutes. **If the test indicates that spillage is occurring and the flue restrictor baffle has been fitted, it should be removed (see overpage) and the test repeated after the fire has cooled.**
- d) If spillage persists, the flue is not functioning correctly and a fault exists. If, after investigation the fault cannot be traced and rectified, the fire must be disconnected from the gas supply and expert advice obtained.
- e) If there is an extractor fan fitted anywhere in the vicinity of the appliance, or in adjacent rooms the spillage test should be repeated with the fan running on maximum and all interconnecting doors open. After ensuring that the fire is safe to use it should be left on high

position to fully warm up. During this time a slight odour may be noticed, this is due to the “newness” of the fire and will soon disappear.

- f) Finally, hand the Installation and Maintenance Instructions / Users Instructions over to the customer and explain the operation of the fire.

Fig. 41

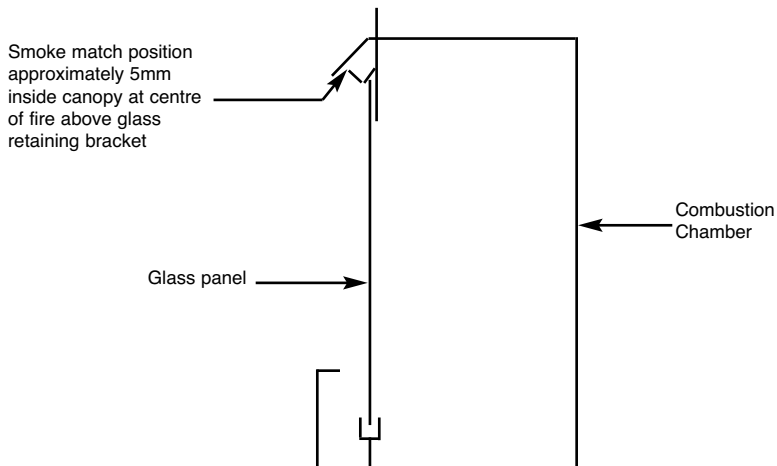

3.4 REMOVAL / RE-FITTING OF THE EFFICIENCY BAFFLE

- a) Remove the glass panel as shown in section 2.6
- b) The efficiency baffle is fitted to the inner roof of the combustion chamber and is secured by 2 off screws.
- c) Remove the screws and pull the efficiency baffle downwards to remove from the appliance.
- d) Replace in reverse order.

3.5 FITTING THE HANDSET WALL BRACKET

- a) The wall bracket is supplied in the loose items pack and is optional to fit.
- b) If fitting the wall bracket, please be advised that the thermostatic sensor is contained within the handset itself, so the position of the wall bracket will therefore be the position of temperature measurement within the room. To fit, position as necessary, mark hole positions, drill and secure with fixings provided.

SECTION 4 MAINTENANCE

Servicing Notes

Servicing should be carried out annually by a competent person such as a GAS SAFE registered engineer. It is a condition of BFM Fires lifetime guarantee scheme that this is carried out by a competent person in accordance with these servicing notes, and must include an oxy-pilot change. The condition of the logs should be checked and if necessary the whole set should be replaced with a genuine replacement set. After any servicing work a gas tightness check must always be carried out. BEFORE ANY SERVICING WORK IS CARRIED OUT ENSURE THE PRODUCT HAS BEEN DISCONNECTED FROM THE ELECTRICITY SUPPLY.

4.1 Removing the burner assembly from the fire.

- 4.1.1 Attach the glass panel clamp as shown in section 2.7
- 4.1.2 Remove the side trims and base trim as shown in section 2.7
- 4.1.3 Remove the glass panel retaining bracket by removing the 5 off retaining screws as shown in section 2.7
- 4.1.4 Remove the glass panel as shown in section 2.7
- 4.1.5 Remove the logs and vermiculite from the burner tray.
- 4.1.6 Remove the burner tray cover by lifting clear.
- 4.1.7 Remove the burner retaining screws as shown in section 2.8
- 4.1.8 Remove the on/off switch from it's retaining bracket on the right hand side as shown in section 2.8
- 4.1.9 Isolate the gas supply at the inlet elbow then disconnect the burner inlet pipe as shown in section 2.8
- 4.1.10 Lift the burner and tilt forwards from the combustion chamber to remove, as shown in section 2.8

4.2 Removing the gas control valve from the fire.

- 4.2.1 Remove the burner from the combustion chamber as described in section 4.1 above.
- 4.2.2 Disconnect the inlet, outlet, pilot pipes and thermocouple connection from the control valve.

4.2.3 Replace in reverse order and carry out a gas test

4.3 Removing the ultrasonic receiver.

4.3.1 Remove the burner from the combustion chamber as described in section 4.1.

4.3.2 Disconnect the control wires from the receiver.

4.3.3 Disconnect the ignition wire.

4.3.4 Re-fit the new receiver and re-fit the control wires to the control valve.

4.3.5 Re-assemble the burner unit to the combustion chamber and carry out a gas tightness test.

4.4 Removing the pilot assembly

4.4.1 Remove the burner from the combustion chamber as described in section 4.1.

4.4.2 Disconnect the pilot supply pipe, ignition wire and thermocouple connection to the gas control valve.

4.4.3 Remove the pilot retaining screws and lift the pilot assembly clear

4.4.4 Re-assemble in reverse order and carry out a gas tightness test.

4.5 Removing the convection fan / thermal switch

4.5.1 Remove the burner from the combustion chamber as described in section 4.1.

4.5.2 Ensure that the electrical supply to the fire is isolated.

4.5.3 Disconnect the wiring to the motor on the convection fan

4.5.4 Remove the retaining screws that hold the convection fan assembly to the base of the combustion chamber.

4.5.5 Disconnect the thermal switch wires.

4.5.6 Lift the convection fan assembly clear if required.

4.5.7 Re-assemble in reverse order.

4.6 Replacing the Batteries in the Handset

4.6.1 Remove and re-fit the new 9V battery by removing the cover on the back of the handset.

4.7 Checking for Flue Debris

4.7.1 Remove the burner assembly as detailed in section 4.1

4.7.2 Locate the removeable backplate on the rear face of the firebox at the bottom.

4.7.3 Remove the 2 screws that hold the removeable backplate on the rear face of the firebox.

4.7.4 Remove any debris.

4.7.5 Replace the removeable backplate on the rear face of the firebox.

4.7.6 Re-assemble in reverse order and carry out a gas tightness test.

Parts Shortlist

Gas control valve	B-92200
Receiver unit	B-153140
Thermostatic handset	B-148120
NG ODS / Pilot	B-128100
LPG ODS / Pilot	B-128110
Convection fan assembly	B-128120
Convection fan thermostat	B-128130
Glass panel	B-128210
Complete log set	B-128240
Log 1 only	B-128250
Log 2 only	B-128260
Log 3 only	B-128270
Log 4 only	B-128280
Log 5 only	B-128290
Log 6 only	B-128300
Log 7 only	B-128310
Glow Fibre	B-139400
Pebble set	B-128320
Vermiculite	CV-107116

SECTION FIVE - USER INSTRUCTIONS

5.1 INSTALLATION INFORMATION

CONDITIONS OF INSTALLATION

It is the law that all gas appliances are installed only by a competent (e.g. Registered) Installer, in accordance with the installation instructions and the Gas Safety (Installation and Use) Regulations 1998. Failure to install appliances correctly could lead to prosecution. It is in your own interest and that of safety to comply with the law.

The fire may be fitted below a combustible shelf provided that the shelf is at least 200mm above the top of the appliance and the depth of the shelf does not exceed 150mm.

The fire may be installed below combustible shelves which exceed 150mm deep providing that the clearance above the fire is increased by 15mm for each 25mm of additional overhang in excess of 150mm.

No purpose made additional ventilation is normally required for this appliance when installed in G.B. When installed I.E. please consult document I.S. 813 : 1996 Domestic Gas Installation which is issued by the National Standards Authority of Ireland. Any purpose made ventilation should be checked periodically to ensure that it is free from obstruction.

If the chimney or flue has been previously used by appliances burning fuels other than gas they must be swept prior to the installation of this fire.

If this appliance is fitted directly on to a wall without the use of a fireplace or surround, soft wall coverings such as wallpaper, blown vinyl etc. could be affected by the heat and hot convection air and may discolour or scorch. This should be considered when installing or decorating.

The Model number of this appliance is as stated on the rating plate affixed to the control panel of the fire and the appliance is manufactured by:-

BFM Europe Ltd
Trentham Lakes
Stoke on Trent
ST4 4TJ

ABOUT YOUR NEW EDEN HE (High Efficiency) GAS FIRE

The BFM Fires Eden High Efficiency log / pebble effect gas fire incorporates a unique and highly developed fuel bed which gives the realism of a loose log layout combined with realistic flames and glow. The fire has a thermostatically controlled convection air fan to increase the efficiency of the product. The convection fan only operates when the fire is up to temperature and therefore may take 20 to 30 minutes to come on when the fire is operated from cold. The use of durable ceramic material in the construction of the fuelbed components ensures long and trouble free operation.

When first using the new fire a slight smell may be noticed. This is due to starch used in the manufacture of the soft ceramic coals, it is non-toxic and will soon disappear.

Please take the time to fully read these instructions as you will then be able to obtain the most effective and safe operation of your fire.

IMPORTANT SAFETY INFORMATION

WARNING

This appliance has a naked flame and as with all heating appliances a fireguard should be used for the protection of children, the elderly and infirm. Fireguards should conform to B.S. 8423 : 2002 (Fireguards for use with gas heating appliances).

It is important that this appliance is serviced at least once a year by a GAS SAFE registered engineer and that during the service the flue debris plate is removed from the fire box and the chimney or flue visually checked for fallen debris or blockages which must be removed. The chimney should also be checked to ensure clearance of flue products. We recommend that during the annual service, replacement of the Oxypilot is carried out. **This is a condition of the manufacturers guarantee. After installation or during servicing a spillage test must always be carried out.**

Rubbish of any type must NEVER be thrown onto the fuel bed, this could affect safe operation and damage the fire.

Any debris or deposits should be removed from the fuel bed from time to time. This may be carried out by referring to the cleaning section as described later in this book. Only the correct number and type of logs must be used and only complete and genuine replacement sets must be used.

Always keep furniture and combustible materials well clear of the fire and never dry clothing or items either on or near to the fire. Never use aerosols or flammable cleaning products near to the fire when it is in use.

The ceramic fuel bed remains hot for a considerable period after use and sufficient time should be allowed for the fire to cool before cleaning etc.

5.2 LIGHTING THE APPLIANCE

IMPORTANT : IF THE BURNER IS EXTINGUISHED FOR ANY REASON YOU MUST ENSURE THAT YOU WAIT A FULL FIVE MINUTES BEFORE ATTEMPTING TO RE-LIGHT THE FIRE.

The BFM Fires Eden HE is controlled by the remote handset supplied with the fire. Ensure the 9V battery as supplied in the loose items pack has been fitted to the handset before attempting to light it. There are 3 modes of operation of the product, “MANUAL mode”, “TEMPERATURE mode” and “TIMER mode”.

5.2.1 Operation of the Fire in “MANUAL” mode

- a) Locate the ON/OFF switch on the appliance, it is situated at the right hand side in front of the glass panel. Ensure that the on / off switch on the valve is in the “ON” (1) position as shown below in Fig.1

Fig. 1



- b) The remote handset is now used to control all functions of the fire. To light the fire, press the “UP” arrow and and “OFF” button simultaneously, as shown on Fig. 2 below. You will hear a click and the fire begins a 30 second ignition process. The pilot and main burner will light. The appliance is now in “MANUAL mode” which will be shown via the “MAN” graphic on the display of the handset as shown below in Fig. 2

Fig. 2



- c) With the product in “MANUAL” mode the fire can now be switched between HIGH rate heat input and LOW rate heat input by pressing the “DOWN” arrow on the handset. To reduce the flame height of the main burner incrementally, press the arrow momentarily. To reduce the heat input directly down to the minimum level, press the “SMALL” flame arrow on the handset twice, “LO” will be displayed. NOTE : The flame will go to HIGH rate heat input before going to designated LOW rate heat input. To return back to HIGH rate heat input press the “LARGE” flame button twice. To put the fire in In “STANDBY MODE” (only the pilot remains lit) press and hold the “SMALL” flame arrow on the handset. See Fig. 3 below

Fig. 3

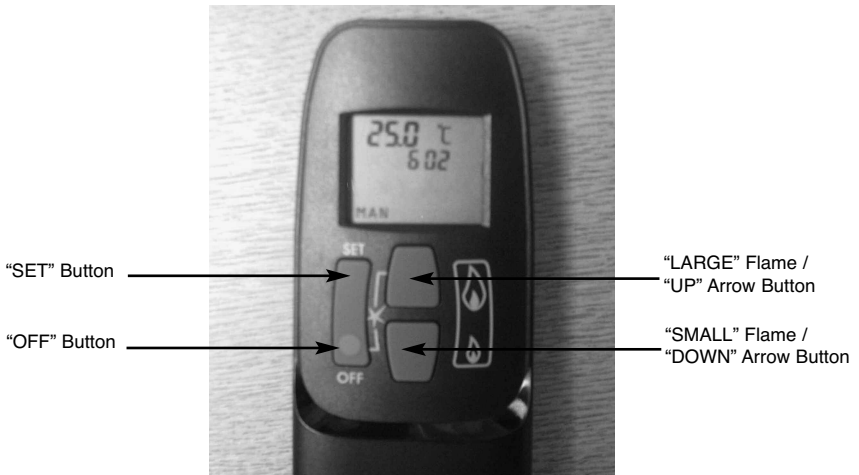

- d) To turn the fire off, press the “OFF” button, this will extinguish all flames including the pilot.

5.2.2 Operation of the Fire in “TEMPERATURE” mode

- a) In order to change the mode of operation from “MANUAL” to “TEMPERATURE”, press the “SET” button, the fire will then change to either “DAY TEMP” (Fig. 4) mode or “NIGHT TEMP” mode (Fig 5). To alternate between the 2, press the “SET” button. **The display on the handset will show the current temperature in the room.**

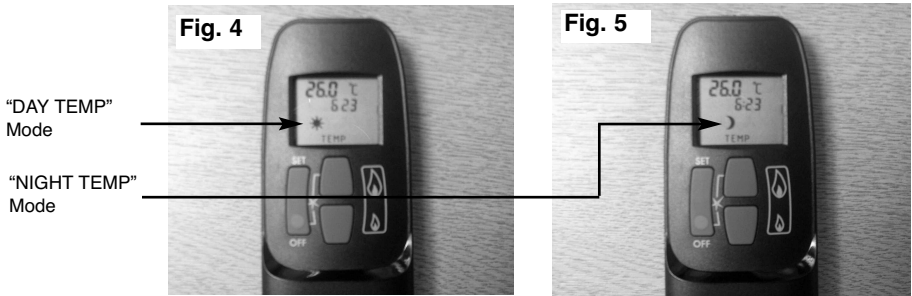

NOTE : The “SET” button allows you to alternate between all modes of operation :- “MANUAL”, “DAY TEMP”, “NIGHT TEMP”, “TIMER” and back to “MANUAL”. Alternatively, pressing either the “UP” or “DOWN” arrow allows the unit to revert to “MANUAL” mode.

- b) Within the “TEMPERATURE” mode there are options for either “DAY TEMP” or “NIGHT TEMP”. These temperatures can be set independently to allow a higher temperature to be maintained at night than during the day, or if setting the same temperature for day and night the fire will compensate for the generally cooler evening temperatures and automatically increase the heat input level accordingly.
- c) To set the temperature, ensure the handset is in “TEMPERATURE” mode and then press the “SET” button until the “TEMP” display flashes then let go. Proceed to set the desired temperature by pressing the “UP” (large flame) or “DOWN” (small flame) arrows as necessary, then press “OFF” to complete the process.
- NOTE :** Minimum temperature is 5°C, Maximum temperature is 30°C, or minimum 41F to maximum 86F when in Fahrenheit mode.
- d) Press the “OFF” button to stop the display flashing or wait to return to “TEMPERATURE” mode. **NOTE :** If you set a temperature below the current room temperature the fire will switch to standby mode (pilot burner only) until the room has cooled to the temperature you have set on the handset display.
- e) If you would like the “NIGHT TEMP” to turn the fire off then decrease the temperature until [----] is displayed.

5.2.3 Operation of the Fire in “TIMER” mode

- a) In order to change the mode of operation from “MANUAL” to “TIMER”, press the “SET” button, the fire will then alternate between the settings until the “TIMER” mode is displayed.

NOTE : The “SET” button allows you to alternate between all modes of operation :- “MANUAL”, “DAY TEMP”, “NIGHT TEMP”, “TIMER” and back to “MANUAL”. Alternatively, pressing either the “UP” or “DOWN” arrow allows the unit to revert to “MANUAL” mode.

- b) Within the “TIMER” setting mode there are two programmable settings you can make over a 24 hour period, namely P1 and P2. To set the timer, ensure the handset is in “TIMER” mode as detailed in section a) above.
- c) To set the P1 timed start setting, press and hold the “SET” button until the P1 (sun symbol is displayed as per Fig. 6 below) and the time flashes. Set the hour by pressing the “UP” (large flame) and set the minutes (in ten minute increments) by pressing the “DOWN” (small flame) as necessary, then press “OFF” button to complete the process. Repeat for the P1 (moon symbol is displayed as per Fig. 7 below) Set the hour by pressing the “UP” (large flame) and set the minutes (in ten minute increments) by pressing the “DOWN” (small flame) as necessary, then press “OFF” button to complete the process.

P1 with “Sun” symbol illuminated

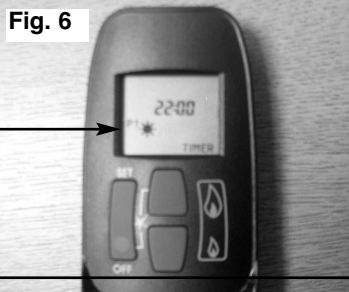

Fig. 6

P1 with “Moon” symbol illuminated



Fig. 7

- d) To set the P2 timed setting, press the “SET” button until the “TIMER” mode is displayed. Hold the “SET” button until the display flashes the current time for P1. Press the “SET” button again to scroll past the setting for P1 (sun) and P1 (moon). The time should now be flashing on the handset. Set the hour by pressing the “UP” (large flame) and set the minutes (in ten minute increments) by pressing the “DOWN” (small flame) as necessary, then press “OFF” button to complete the process.

5.3

IMPORTANT SAFETY INFORMATION

WARNING

This appliance is not intended for use by persons (including children) with reduced physical, sensory or mental capabilities, or lack of experience and knowledge, unless they have been given supervision or instruction concerning use of the appliance by a person responsible for their safety. Children should be supervised to ensure that they do not play with the appliance.

This appliance has a naked flame and as with all heating appliances a fireguard should be used for the protection of children, the elderly and infirm. Fireguards should conform to B.S. 8423 : 2002 (Fireguards for use with gas heating appliances).

It is important that this appliance is serviced at least once a year by a GAS SAFE registered engineer and that during the service the flue debris plate is removed from the fire box and the chimney or flue visually checked for fallen debris or blockages which must be removed. The chimney should also be checked to ensure clearance of flue products. We recommend that during the annual service, replacement of the Oxypilot is carried out. **This is a condition of the manufacturers guarantee. After installation or during servicing a spillage test must always be carried out.**

THE FIRE MUST NOT BE OPERATED WITH THE GLASS CRACKED, BROKEN OR REMOVED.

Any debris or deposits should be removed from the fuel bed from time to time. This may be carried out by referring to the cleaning section as described later in this book. Only the correct number and type of logs or pebbles must be used and only complete and genuine replacement sets must be used.

Always keep furniture and combustible materials well clear of the fire and never dry clothing or items either on or near to the fire. Never use aerosols or flammable cleaning products near to the fire when it is in use.

The ceramic fuel bed remains hot for a considerable period after use and sufficient time should be allowed for the fire to cool before cleaning etc.

SPILLAGE MONITORING SYSTEM

This appliance is fitted with a spillage monitoring system which shuts down the fire if the evacuation of combustion products from the fire is affected by a partially or fully blocked flue. If this system operates the fire will go out. If this occurs, leave the fire for at least three minutes then follow the lighting procedure as described in the previous section. **In the event of repeated operation a GAS SAFE registered gas installer must be called to investigate and rectify the cause.**

5.4 CLEANING - WARNING

Before attempting any cleaning operation ensure that the fire has been allowed to fully cool.

CLEANING THE ENAMELLED METAL PARTS

These enamelled parts should only be cleaned using a clean, damp cloth. The trim is best cleaned by removing it from the fire and placing it face up on a flat surface. **Abrasive cleaners, chemical cleaning agents or any type of polish must never be used as damage to the finish may result.**

CLEANING THE FUEL BED

We do not recommend cleaning of logs or fuelbed components as these are fragile and damage may result. **None of these parts must be washed or exposed to any cleaning agents or water.** Any damaged parts must be replaced by contacting your dealer or telephoning BFM Fires on the number stated on the rear cover of this book. Logs or pebbles must only be replaced with a complete and genuine replacement set and the fire must never be run with the wrong number or damaged logs or pebbles. The fuelbed must be carefully re-assembled as stated in the following section.

CLEANING THE GLASS PANEL

To clean the glass panel, please remove it from the product as described overpage on pages 42-43. Use a clean damp cloth and ceramic glass cleaner to remove any stains or deposits from the glass panel. Do not use scouring pads as this may scratch the surface finish of the glass panel.

PLEASE NOTE :- The glass will require cleaning periodically. Condensation produced by the products of combustion will create marks on the inside face of the glass panel.

CLEANING - REMOVING / REPLACING THE GLASS PANEL

- a) To remove the glass frame, the glass clamp as supplied in the loose items pack will be required. Secure the clamp to the glass panel as shown below in Fig. 8

Fig. 8



- b) Remove the front grill by removing the 2 off retaining screws from the upturned tabs, 1 off at each end of the trim. Remove the side trims by simply lifting clear (they are retained by magnets). See Fig. 9 below.

Fig. 9

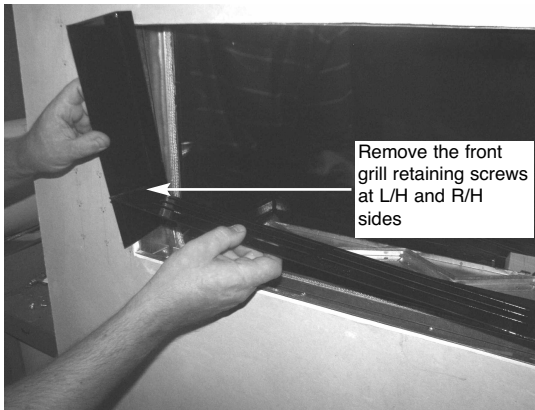

NOTE : Always ensure that a consistent seal between the combustion chamber and the glass frame is achieved when replacing the glass panel.

- c) Remove the 5 off securing screws and glass panel retaining bracket that are located on the top underside face of the combustion chamber behind the canopy. See Fig. 10 below.

Fig. 10

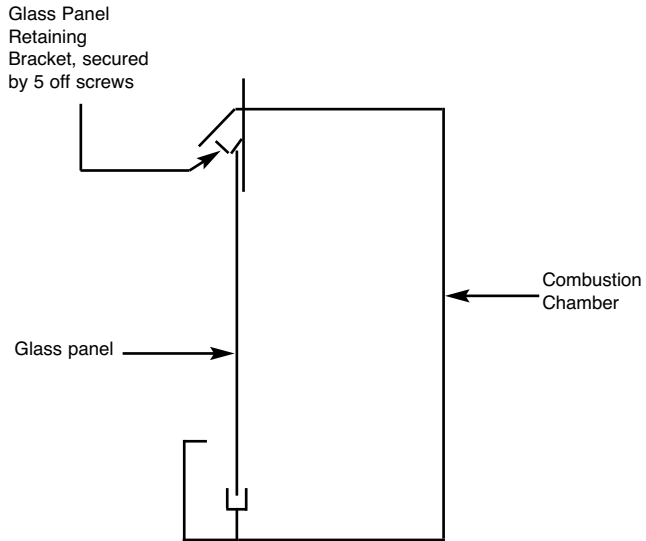

- c) Lift the glass panel vertically to release from the bottom retaining channel and then tilt forwards as shown below in Fig. 12 / 12 to release.

Fig. 11

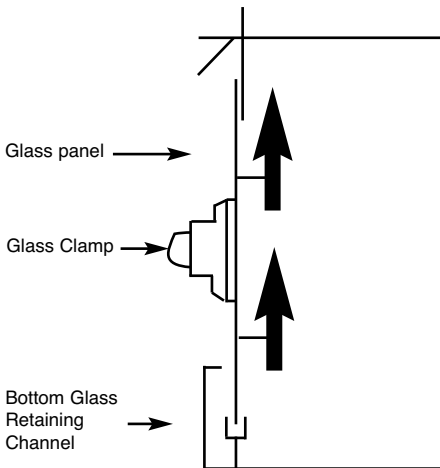
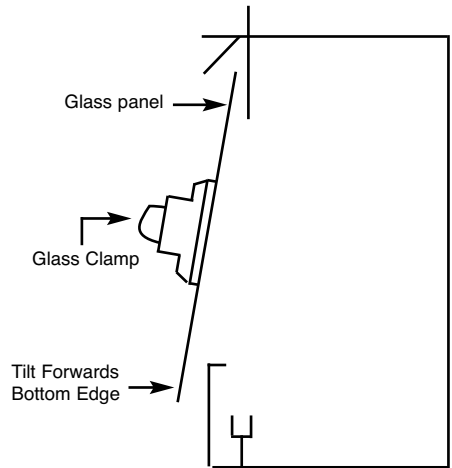

Fig. 12



5.5 A REMOVAL AND REPLACING THE FUEL-BED LOGSET

IF FITTING THE PRODUCT WITH THE PEBBLE FUELBED, PLEASE PROCEED TO SECTION 5.5B.

Remove the glass panel as shown on pages 42-43 before attempting to remove or replace the logs.

- a) The vermiculite material should then be first layed around the burner tray as shown below in Fig. 13, resulting in an even layer.

Fig. 13



- b) Place Log "1" at the left hand side of the burner tray fitting the holes in the bottom face of the log onto the 2 off location pegs as shown below in Fig. 14

Fig. 14



- c) Place Log “2” at the right hand side centre of the burner tray fitting the hole in the bottom face of the log onto the single location peg as shown below in Fig. 15

Fig. 15

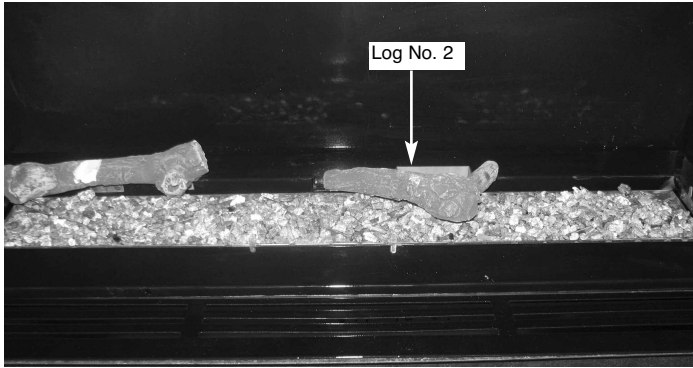

- d) Place Log “3” at the right hand side of the burner tray fitting the hole in the bottom face of the log onto the single location peg as shown below in Fig. 16

Fig. 16



- d) Place Log "4" at the centre of the burner tray fitting the holes in the bottom face of the log onto the 2 off location pegs as shown below in Fig. 17

Fig. 17

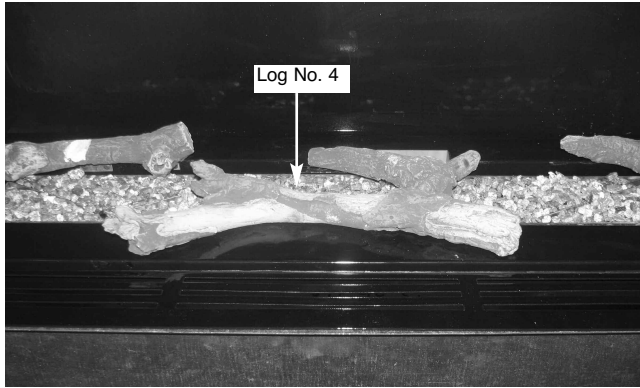

- e) Place Log "5" at the right hand side of the burner tray locating in the groove of Log "3" as shown below in Fig. 18

Fig. 18

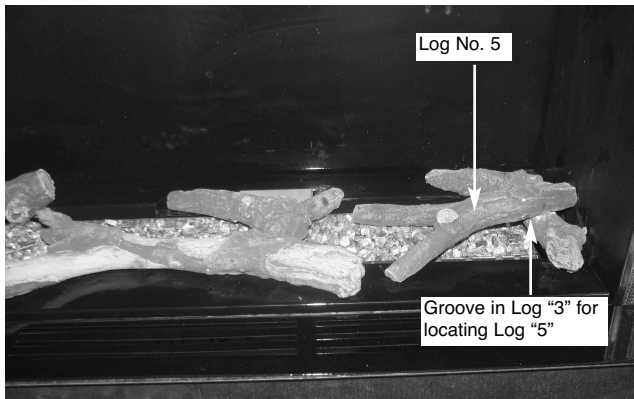

- f) Place Log “6” at the left hand side of the burner tray locating in the groove of Log “1” as shown below in Fig. 19

Fig. 19

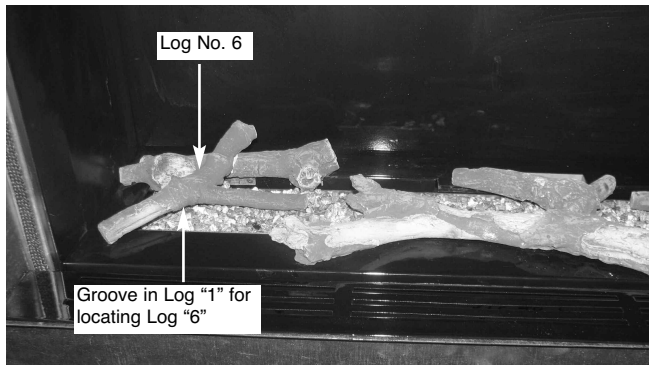

- g) Place Log “7” to the left hand centre side of the burner tray locating on the branch of Log “1” as shown below in Fig. 20

Fig. 20

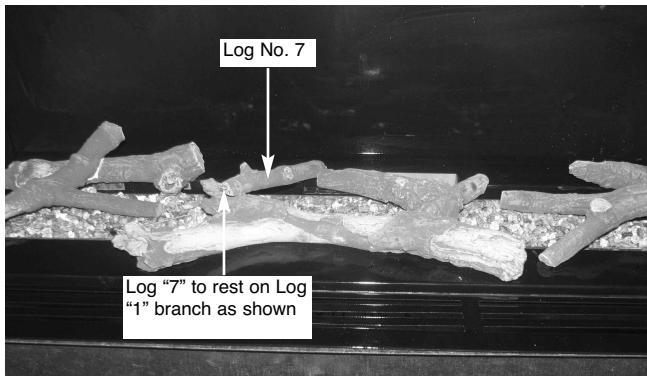

- h) If required, fit the embaglow material over the flame ports. To do this, separate into short strands and place randomly over the flame porting area as shown below in Fig. 21. **This material is only supplied to improve flame aesthetics and is optional to install.**

Fig. 21

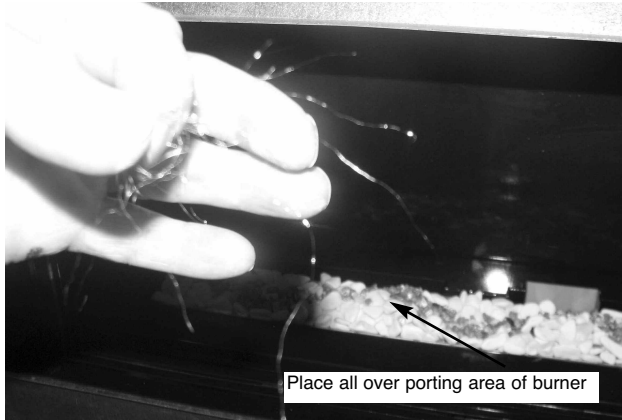

- i) Refit the glass panel as described on pages 42-43, then light the appliance as described as in section 5.2

IMPORTANT NOTE : PLEASE ENSURE THAT WHEN COMMISSIONING THE FIRE THE FLAME PATTERN IS EVEN ACROSS THE WIDTH OF THE BURNER. IF AN UNEVEN FLAME PATTERN IS FOUND THEN RELAY THE QUANTITY VERMICULITE TO ACHIEVE AN EVEN FLAME PATTERN.

Warning : Use only the logs supplied with the fire. When replacing the logs remove the old logs and discard them. Fit a complete set of logs of the correct type. Do not fit additional logs or any logs other than a genuine replacement set.

This appliance does not contain any component manufactured from asbestos or asbestos related products.

5.5 B REMOVAL & RE-FITTING THE FUEL-BED PEBBLES

Remove the glass panel as shown in on pages 42-43 before attempting to remove or replace the logs.

- a) Fit the pebbles to the burner tray as shown below in Fig. 17, do not fill the flame ports in the burner with pebbles.

Fig. 17

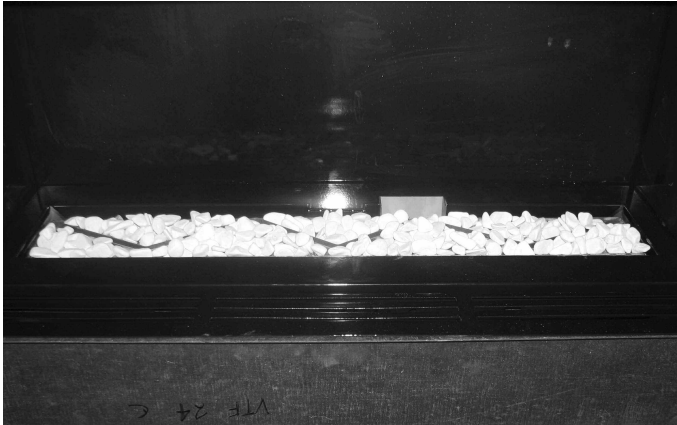

- b) Fit the vermiculite material into the burner ports as shown below in Fig. 18. **This material must be fitted in an even layer to ensure correct operation of the fire.**

Fig. 18

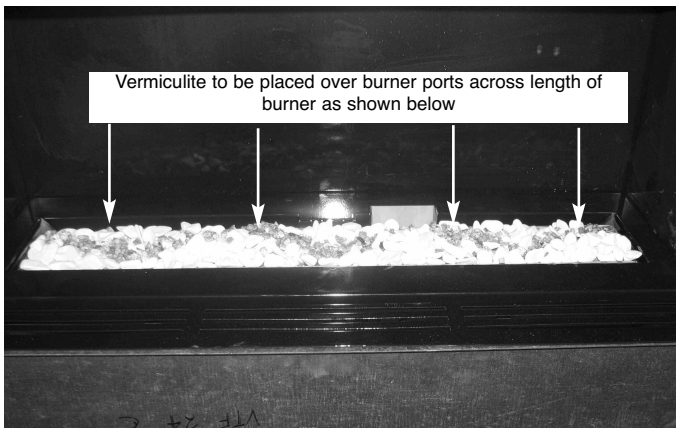

- c) If required, fit the embaglow material over the flame ports. To do this, separate into short strands and place randomly over the flame porting area as shown on previous page in Fig. 17. **This material is only supplied to improve flame aesthetics and is optional to install.**

- d) Refit the glass panel as described on pages 42-43, then light the appliance as described as in section 5.2

User Replaceable Parts

Glass panel	B-128210
Complete log set	B-128240
Log 1 only	B-128250
Log 2 only	B-128260
Log 3 only	B-128270
Log 4 only	B-128280
Log 5 only	B-128290
Log 6 only	B-128300
Log 7 only	B-128310
Glow Fibre	B-139400
Pebble set	B-128320
Vermiculite	CV-107116

Due to our policy of continual improvement and development the exact accuracy of illustrations and descriptions contained in this book cannot be guaranteed

Part No. B-126570
Issue 8

BFM Europe
BRITISH FIRE MANUFACTURERS

BFM Europe Ltd.
Trentham Lakes
Stoke-on-Trent
Staffordshire
ST4 4TJ

www.bfm-europe.com

Telephone - General Enquiries : (01782) 339000
Telephone - Service : (0844) 7700169