

Arden

Stove



PLEASE RETAIN THESE INSTRUCTIONS FOR FUTURE REFERENCE

BK018

EN 13240:2001

Rev 07
February 2008
Parts No: AFS1080

07 

WARNING

IT IS A LEGAL REQUIREMENT THAT THE INSTALLATION OF ALL NEW OR REPLACEMENT, WOOD OR SOLIDFUEL HEATING APPLIANCES ARE REQUIRED TO OBTAIN BUILDING CONTROL APPROVAL FROM YOUR LOCAL AUTHORITY OR THE INSTALLATION WORK MUST BE CARRIED OUT THROUGH A GOVERNMENT APPROVED COMPETENT PERSONS SCHEME SUCH AS OPERATED BY HETAS.

IF IN DOUBT, CONTACT HETAS LIMITED
TELEPHONE NUMBER : 0845 634 5626
www.hetas.co.uk

THIS STOVE MUST NOT BE CONNECTED
TO A SHARED FLUE SYSTEM

TO ALL USERS
PETROLEUM COKE
SOME OF WHOSE BRAND NAMES ARE
'CALCO', 'PETROCOKE' AND 'WONDERCO'
MUST NOT BE BURNED IN THIS APPLIANCE

BITUMINOUS HOUSE COAL
SHOULD NEVER BE USED IN YOUR STOVE

TO USE THESE FUELS WILL INVALIDATE
THE APPLIANCE GUARANTEE.

IF IN DOUBT CONTACT THE SOLID FUEL ASSOCIATION
TELEPHONE NUMBER 0845 601 4406
www.solidfuel.co.uk

© Copyright 2007

Valor Ltd

This booklet has copyright & may not be copied in whole or part or be used for any purpose other than that for which it is supplied without express written consent from Valor Limited.

**Operating & Installation Instructions
Contents****Introduction**

Safety Notices	4
The Principle of the Stove	4
Check List	5
Technical Data	6

Installation

General Precautions	7
Handling	7
Hearth	7
Combustible Materials	7
Air For Combustion	7
Fitting The Feet	8
Fire Box Liner Panels	8
Fitting The Flue Outlet & Hotplate	9
Sealing of Terminals	9
Flues & Chimneys	9 -12
Final Check	13
Building Control consent Checklist	14

Servicing & Maintenance

Annual Maintenance	15
Cleaning	15
Chimney Sweeping	15
Door Glass	15
Outer Finish	15
Summer storage/Non Usage	16
Disassemble Airwash	16
Adjusting The Door Hinges	16
Fire Door Glass Replacement	17
Fire Door Rope Replacement	18

Operating Instructions

Fuel Types	19
Lighting The Fire	19
Reduced burning	20
Over-Firing & Chimney Fires	21
Multi-purpose operating Tool	21
Air Inlet Controls	21

Spare Parts List 22**Guarantee** 23**Final Factory Check List** 24

Safety

A fireguard conforming to BS 8423:2002 should be used in the presents of children and old or infirm people.

Please note, this appliance should be used with the fire door closed at all times except when re-fuelling or de-ashing.

Do not use aerosol sprays or any other flammable materials near the appliance under fire.

Do not fit an extractor fan in the same room as the appliance.

Fire cement is caustic, hand and eye protection should always be worn, prolonged contact with the skin should be avoided.

Valor will not be responsible for any consequential or incidental loss or injury however caused.

Before continuing any further, with the installation of this appliance please read the following guide to manual handling.

- Always obtain assistance when lifting the appliance
- When lifting always keep your back straight, bend your legs not your back
- Avoid twisting at the waist. It is better to reposition your feet.
- Avoid upper body/top heavy bending. Do not lean forwards or sideways when handling the fire
- Always grip with the palms of your hands do not use your fingertips for support
- Always keep the stove as close to the body as possible as this will minimise the cantilever action.
- Use gloves to provide additional grip.

The Principles Of The Stove

Your **Arden** stove is built to the highest standard of craftsmanship using the best materials and the most modern equipment available. It is a highly efficient and sophisticated piece of machinery and when properly installed and operated it should provide a lifetime of heating satisfaction.

Safety is the most important consideration when installing your fire. If not properly installed and operated a house fire may result. Installation must comply with the Building Regulations and conform to all safety standards.

Valor produce a variety of appliances ranging from the traditional to the modern in style and appearance, all bristling with 'High Tech' features.

The fire door is fitted with a special high temperature ceramic glass panel through which the fire can be viewed.

The stove is lined with firebricks or heat reflective panels which ensure complete combustion and provide a good heat store to even out fluctuations in burning.







An internal throat plate produces turbulence to encourage secondary combustion and direct the flue gas around the whole upper firebox before allowing it to escape up the chimney.

Valor stoves are also fitted with an 'air wash' so called because it provides a curtain of high speed preheated air behind the glass to help keep it clean and provide secondary air/over draught.

The provision of two inlets on all stoves gives a wide range of primary / secondary air, under draught/over draught combinations. The optimum setting will only be established by experience in firing the appliance, and will depend on the type of fuel, the position of the appliance in the house, and conditions of chimney etc.

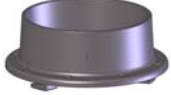
CHECK LIST

Inside the appliance you should find the following components :

Part Description & Visual Aid (not to scale)	Quantity
1. Fuel grate 	1
2. Feet & Fixings 	4
3. Throat Plate 	1
4. Flue Spigot 	1 (4")
5. Hot Plate 	1 (4")
6. Ash Pan 	1
7. Operating Tool 	1
8. Rear Liner 	1
9. Side Liners 	2
10. Instructions 	1

TECHNICAL DATA

Technical Data	Arden
Nominal Heat Output (kW)	5.5
Efficiency Nett (%)	81.4
Mean Flue Gas Temperature (c)	267
Mean Co Emission @ 13% O ₂	0.59
Flue Mass Gas Flow (g/s)	3.2
Minimum Distance to Combustible Material (mm)	Rear - 700 Side - 500
Height (mm)	540
Width (mm)	405
Depth (mm)	362
Height to centre of rear flue (mm)	440
Depth from back to centre of flue (mm)	105
Flue diameter (mm)	102 (4")
Weight packed (Kg)	47

General Precautions

Note - All local regulations, including those referring to National and European standards need to be complied with, when installing the appliance.

The Building Regulations for England and Wales 2000 ref Approved Document J 2002 edition (issued by the DTLR) The Building Standards (Scotland) (Consolidation) regulations.

Detailed recommendations for installation of appliances, chimneys and flues are outlined in the current issue of the following British standards:- BS6461, BS8303, BS4543.

Any Manufacturers Instructions must not be taken as overriding statutory requirements.

Before any installation work is undertaken consideration must be given to the Health & Safety at work act 1974. Safe working practices should be followed at all times.

During installation ensure that adequate precautions are taken to avoid unnecessary risk to yourself of any householder. In particular the danger from the caustic nature of the fire cement should be avoided by using these accepted methods:

- Wear gloves when handling fire cement
- Wear goggles when chiselling or looking up chimneys

Make sure that the building Regulations are adhered to during installation along with any local by-laws. In the case of heating systems make sure that the pipe work is correctly bonded to ensure electrical continuity.

Asbestos

All Valor stoves contain no asbestos in their manufacture or construction. If there is a possibility of disturbing any asbestos in the course of installation, then please seek specialist guidance and use appropriate protective equipment.

Handling

The Safety and handling guidelines as set out on page 4 of this manual should be followed. To make movement easier internal fittings, fuel retainers, grates, firebox liners, flue outlets, hot plate, throat plate, etc., can be removed. Care should be taken to make sure that the hinges are not damaged during installation.

Hearth

The stove shall be installed on a floor with adequate load-bearing capacity. If the existing construction does not meet this prerequisite, suitable measures (eg; load distributing plate) should be taken to achieve it.

Ideally, the hearth should stand on a constructional hearth of non-combustible materials not less than 125mm (5") thick conforming to Building Regulations. Dimensions of the hearth should project at least 300mm (12") forward of the front of the appliance and 150mm (6") at the sides.

The surface of the hearth should be free of combustible materials. In most buildings with solid concrete or stone floors, the requirement will be met by the floor itself, but mark the perimeter of the hearth to ensure coverings are kept away, or use different levels to mark the hearth perimeter

Combustible Materials

A gap of 700mm (Rear) and 500mm (Sides) should be allowed between the appliance and any combustible materials.

Ideally, adjacent walls should be of suitable non-combustible construction, preferably brickwork. In large fireplaces take care that any supporting beam is protected by 13mm (0.5") sheet of Masterboard / Supalux, spaced 13mm (0.5") off the surface with strips of non-combustible material. Make sure that there is a gap between any un-insulated flue system and any combustible material. This gap must be at least 3 x the outside diameter of the flue pipe, or 1.5 x the flue diameter to non combustible surfaces. See illustration on page 12.

Air for combustion

There must always be a permanent means of providing air for combustion into the room in which the stove is installed. A permanent vent with a total free area of at least 550mm² for every KW rated above 5KW should be connected directly to the outside air or to an adjacent room which itself has a permanent vent of the same size direct to the outside air. The positioning of any air vent must be so, that it cannot be liable to blockage or obstruction.

Please note : The fitting of an extractor fan to either of these rooms is not recommended Please see note on page 10.

INSTALLATION

Fitting The Feet

The Valor Arden can be fitted with or without feet.

Care should be taken whilst assembling the feet so as not to damage the painted surface of the stove.

- The feet are positioned in each corner of the stove and fitted using the washers and screws provided
- You will need a No. 2 Pozidrive screwdriver to tighten the screws
- Use the cardboard packaging to rest the stove on its back while fitting.

Firebox Liner Panels

The **Arden** stove uses firebox liner panels to the sides and back. The throat plate sits on top of the side and rear panels. These should come fitted in your stove, if however they are not, proceed as follows to fit them.

- Remove the front fuel bars or grate
- Set the small liner into the back of the stove
- Insert side liner panels into each side of the stove
- Fit the throat plate with the single bend and two cut outs to the front facing up. The projecting lugs sit on top of the side liners. The long centre tab on the back edge rests on the rear liner. The shorter turn-down tabs against the vertical face.
- Replace the front fuel retainer bars or grate

Note: Neither the rear firebox liners or the side firebox liners are 'handed', both faces are suitable for direct contact with the fire.

Note: cracking of the lining panels does not effect efficiency of the stove.



Fig. 1 Liners inserted into the Arden



Fig. 2 Inserting the throat plate



Fig. 3 Liners, throat plate and grate in the Arden

Removal Of The Throat Plate

Blocked chimneys cause dangerous fumes to escape. Remove the throat plate at least monthly to clean. Keep chimney and flue ways clear.

INSTALLATION

Fitting the Flue Outlet and Hot Plate

The flue outlet spigot is found packed inside the appliance. The hot plate (blanking plate) is supplied fitted to the top opening and is removed by turning clockwise (as is the flue outlet).

Smear a very thin layer of fire cement on the mating faces of the flue outlet and the hot plate. Fit the outlet to the appliance in the desired position.

Lock into place by rotating anti-clockwise and tighten by tapping with a block of wood and mallet from inside of the appliance. Similarly, fit the hot plate (blanking plate) to the unused opening. Clean off any surplus fire cement. Place appliance on the hearth and make sure that it is level and does not rock. Connect the chimney ensuring all joints are sealed with fire cement.

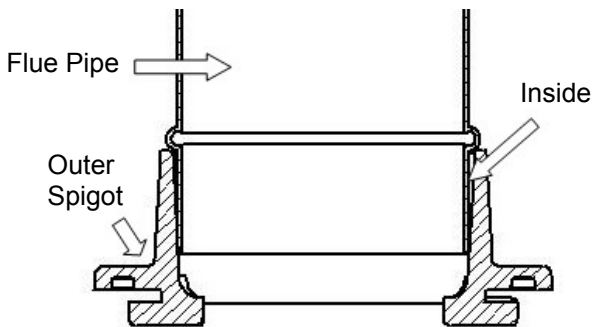

Fig 4. Flue & Spigot Fitting

Note: The flue pipe must be fitted inside the outlet spigot. Failure to do so could result in the spillage of condensation running down the flue.

SEALING OF TERMINALS

please ensure that the two partially cut circular terminals (located on the rear of the appliance) are sealed with fire cement, and thus preventing surplus air entering the firebox, resulting in less efficiency and poor fuel consumption.

Flues and Chimneys

The flue draw is critical on any installation and should be checked to ensure that it matches what is specified. If it is higher than recommended, provision must be made to correct the over draw. The draw can vary in different weather conditions and the customer should be made aware of this. Failure to correct an over-drawing flue will invalidate the warranty.

Please remember that chimney draught is dependent on four main factors :

- Flue gas temperature
- Flue height
- Flue size
- Flue terminal

The stove must be connected to a suitable and efficient flue that products of combustion (fumes) from the stove outlet to the outside air. To ensure a good up draught it is important that the flue gases are kept warm and that the flue size suits the stove. The termination of the outlet at the top of the flue also needs to comply with Building Regulations. The minimum effective height of the flue must be at least 4.5 metres from the top of the stove to the top of the flue outlet. When warm the flue draught should be between 0.1 to 0.2 mb. A chimney may comply with regulations but still be subject to down draught and similar problems. A chimney terminating above the ridge level is generally less likely to suffer such problems.

If a new chimney is being provided it should fully comply with the relevant Building Regulations that specify the requirements for solid fuel burning installations. Suitable types of chimney include the following :

Masonry Chimney : Built with clay or concrete liners, or a chimney block system meeting Building Regulations. These types of chimney should be installed in accordance with the Building Regulations and BS 6461:Part 1.

Factory Made Insulated Chimney : Complying with BS 4543:Part 2 (often called "Class 1 prefabricated metal chimney"). These types of chimney should be installed in accordance with Building Regulations and BS 7566: Parts 1 to 4.

INSTALLATION

Due to the gradual introduction of Europe Chimney Standards chimneys will be specified according to their performance designation as defined in BS EN 1443 that covers the General Requirements for chimneys. The minimum performance designation required for use with solid fuel burning stoves is T450 N2 S D3.

The flue and chimney installation must be carefully checked by a competent person before fitting the stove to ensure it is suitable and will work safely.

If the chimney is old (ie: built of brick or stone without a liner) or being opened up for reuse additional checks and smoke testing as described in Appendix E of the Approved Document J 2002 Edition should also be carried out to ensure the flue and chimney are good operating condition.

Unless the existing flue is in good condition with suitable access for collection and removal of debris. If the flue size is more than 225mm (9") diameter or 200mm (8") X 200mm (8") square, a suitable lining of 150mm (6") diameter should be fitted, or if the flue length is over 5.5 metres one size larger than the appliance outlet should be fitted. This should be a double skin stainless steel flexible liner that is independently certified for use with solid fuel. Details of suitable linings for use with wood & solid fuel are given in the Official HETAS guide that can be viewed on their website at www.hetas.co.uk.

It is also important that suitable flue pipe complying with the Building Regulations is used to connect the stove to the flue in the chimney and that suitable access is provided into the flue for regular inspection and sweeping of the flue ways.

The installer should comply with Building Regulations requirements in respect of providing a Notice Plate giving details on the chimney, flue lining, hearth and fireplace installation. Approved Document J of the Building Regulations for England & Wales is available from The Stationary Bookshops and can also be viewed at the ODPM website at www.safety.odpm.gov.uk/bregs/brads.htm.

Details on the relevant Building Regulations and BS British Standards are given in the "General Precautions" section of these instructions.

Chimneys should be as straight as possible. Horizontal runs should be avoided except where

the rear outlet of the appliance is used, in which case the horizontal section should not exceed 150mm (6") in length.

If the stove appears to be working hard but produces very little output to the room it is likely that excess draw is present in the chimney, and that heat is being sucked out of the appliance and up the chimney. If this is the case we recommend the fitting of a draught stabiliser in preference to a flue damper, in the interest of safety and efficiency.

FOR ALL APPLIANCES

Access for cleaning the flue should be incorporated in the system other than through the appliance (eg: a soot door or access through register plate). Purpose made soot doors and inspection lengths are available from manufacturers of all systems. Ensure that the whole length of the flue can be reached from the soot door.

Note: if the appliance is fitted with a draught stabiliser or if one is fitted to the flue pipe or chimney in the same room as the appliance, then the permanent air entry opening (or Openings) should be increased by 300 mm² for each KW of rated output.

For advice on flues and chimneys contact:

**NACE (National Association of Chimney Engineers) Telephone : 0800 0924019
www.nace.org.uk**

OR

**NACS (National Association of Chimney Sweeps) Telephone : 01785 811732
www.chimneyworks.co.uk**

OR

**HETAS (Official Body To Approve Solidfuel Domestic Heating Appliances)
Telephone : 0845 6345626
www.hetas.co.uk**

NOTE - Under no circumstances should this appliance be connected to a shared flue system, that serves any other heating appliance.

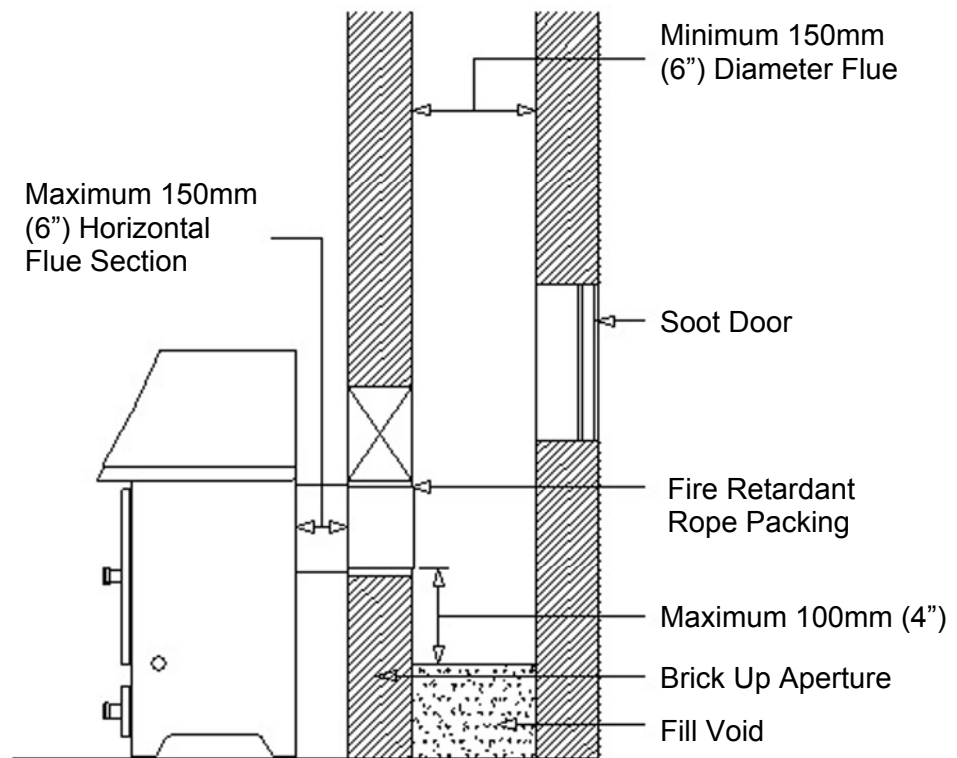

TYPICAL REAR FLUE OUTLET (as per BS 8303-1)

INSTALLATION

Typical Metal Insulated Chimney System

To Be Installed To The Chimney Manufactures instructions in compliance With Building Regulations And BS 7566 Part 1 to 4

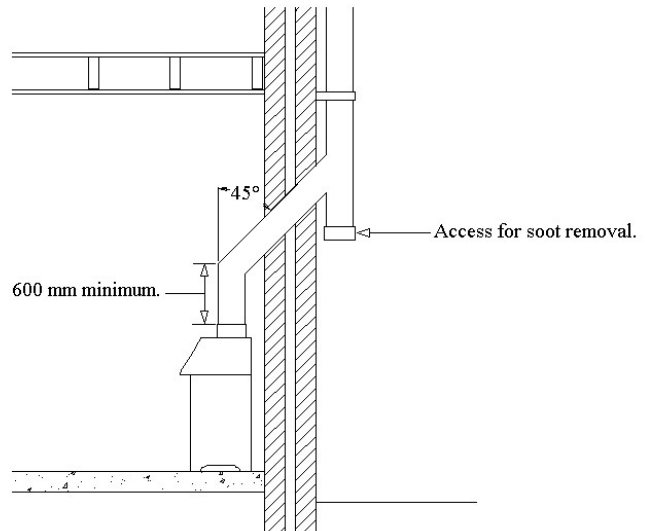
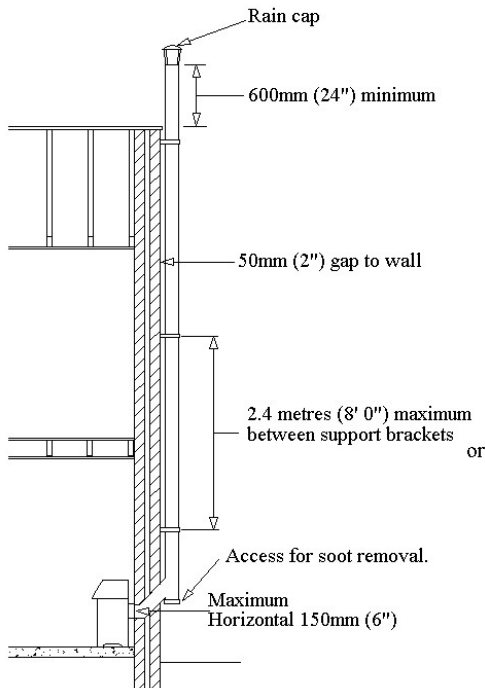

PLAN VIEW OF REGISTER PLATE AND CLEARANCES FOR NON INSULATED FLUES

(Plan View Of Steel Register Plate, 1.5mm Thick Minimum)

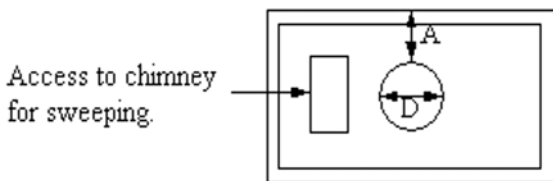

A (Minimum clearance for non-insulated flue) =
 1.5 x D to a non-combustible surface/material
 or
 3 x D to a combustible surface/material

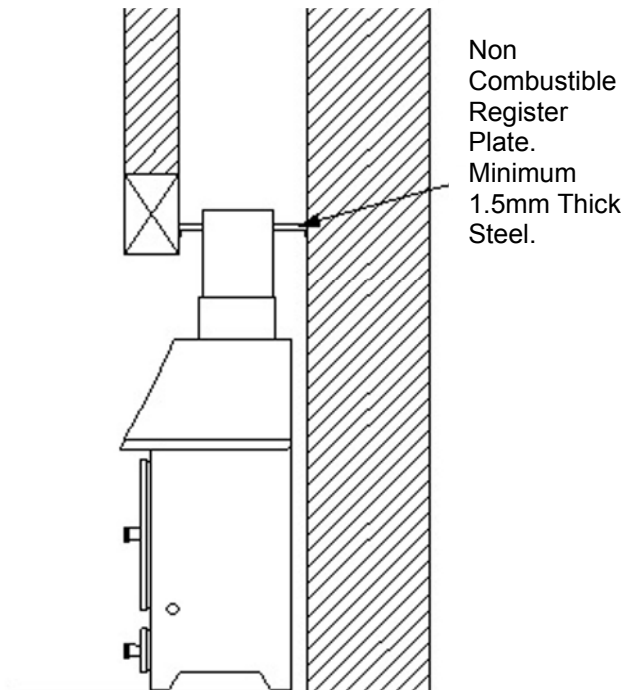

TYPICAL TOP FLUE OUTLET (as per BS 8303-1)

Final Check

Before handing over the installation to the customer it is a requirement under Document J that the appliance is lit, and the functioning of the chimney system is checked for satisfactory operation.

- **Be sure that the chimney is operating and that ALL the smoke and fumes are vented to the atmosphere through the chimney terminal**
- **Check all joints and seals**
- **Clean the outside of the appliance to prevent any stains becoming burnt on.**
- **Check the flue draught which should read 1 - 2mm H₂O / 0.1 - 0.2mbar**
- **If Building Control Consent route is being sought please complete the check list on page 14.**
- **For Registered Competent persons Scheme such as HETAS, please complete the Certificate of Compliance, which is used for checking and reporting the installation as imposed by the government**
- **Explain the controls and operation of the appliance to the customer**

Checklist

The following details **must** be checked and completed in full by the installer at the time of installation. Please answer all the questions on the **Checklist** (page 14) as **fully** as possible. **Valor** can not be held responsible for chimney or installation problems or faults

Annual Maintenance

It is important that your appliance is regularly serviced in accordance with these instructions. This should be carried out at least annually by a qualified person and should consist of the following :

Cleaning

Important; Under some circumstances soot can quickly build up on the throat plate and adjacent areas. The throat plate should be removed and checked monthly, and any debris stripped off. Similarly, clean the upper surface of the firebox.

Remove the firebrick linings and throat plate, inspect all rope gaskets on doors, glass etc, and re-order any items that may need replacing from your **Arrow** dealer.

With a wire brush clean inside the appliance paying particular attention to the small inlet holes of the air wash on the inside, above the fire door.

Sweep the chimney and confirm that it is sound. Examine all joints in the flue pipe etc, and re-seal if necessary. Re-assemble and leave with the air inlet and air wash control about half way open. This will allow a free flow of air through the appliance thus preventing moisture and condensation from building up inside the stove and chimney.

Chimney Sweeping

Sweeping should be carried out with an appropriate sized bristle brush and rods to suit chimney size and type. As with all appliances regular sweeping of the flue is essential to avoid danger of blockage and the escape of poisonous fumes. Access for cleaning should also be incorporated in the chimney (e.g.. Soot door or access through the register plate).

Any existing chimney should be swept prior to installation of the appliance, and swept again a second time **within one month** of regular use after installation to establish frequency of sweeping required. This should be done by a competent person such as a NACS chimney engineer who will provide a Certificate Of Chimney Sweeping. The whole flue way including the outlet must be swept at least twice per burning season. It is important that the flue ways, flue pipe and chimney be cleaned prior to lighting the fire after a prolonged shut down period.

Door Glass

The door glass should remain clear during normal burning. However, under certain conditions, such as burning at a low rate or damp wood, or overnight burning, the glass may become somewhat blackened. To remedy this, operate the appliance at a fast rate. Alternatively when the stove is cold, open the door and clean the inside face of the glass with a damp cloth or with glass cleaner (available from fire stockists). A piece of cloth moistened with vinegar and dipped in wood ash (**not coal ash**) will provide a good soft scourer to remove the soot without scratching the glass.

Outer finish

The outer finish of the appliance is a durable high temperature paint. It is best cleaned, by brushing down, with a clean shoe brush. Do not allow moisture to remain on the appliance whilst cold or surface rust may form.

The high temperature paint should not require attention for some time, depending on use. The hotter the fire burns sooner repainting will be necessary. Aerosol tins of paint are available for complete refurbishing.

Before repainting make sure that the fire is out and the stove is cold.

- Remove the door glass
- Lightly wire brush, or rub with wire wool, the body of the appliance to remove any loose paint or rust.
- Mask or remove items such as brass work.
- Any adjacent brickwork, mantelpiece, hearth etc, should be carefully masked for quite a distance around the appliance. (This precaution is to prevent discolouration of the surrounding brickwork or wall paper etc.)

Re-spray in a well ventilated area, avoid breathing the vapour. Refer to safety instructions on paint cans.

- When the paint is dry refit the door glass & any other parts previously removed.
- Leave the appliance for eight hours before lighting a fire.
- Burn slowly for the first four hours, then build up heat slowly to gradually cure paint.

Note: Use genuine Valor touch up spray as some paints interact. This could ruin the finish and invalidate the guarantee.

SERVICE & MAINTENANCE

SUMMER STORAGE/NON USAGE

Please ensure that your stove is left clean and moving components are well lubricated for the summer months (during periods of prolonged non use). If possible store the throat plate outside of the stove, check all moveable components at regular intervals to ensure they are moving freely.

Allow air movements through the stove by opening the air wash and primary inlets controls to about half way open or leave the door ajar. This will allow a free flow of air through the stove thus preventing moisture and condensation forming inside the stove and chimney. This preventative maintenance will ensure your stove stays in the best condition for the coming winter months.

DISASSEMBLE THE AIR WASH

The Valor Arden air wash may be disassembled for cleaning or adjustment. To achieve this, the following procedure should be followed.

This should only be carried out when the fire is cold and unlit

- Support Airwash cover with one hand
- Move cover up by smartly tapping the bottom with a hammer (Fig. 5)
- Remove assembly from appliance
- Clean and / or adjust
- Refit using reverse procedure

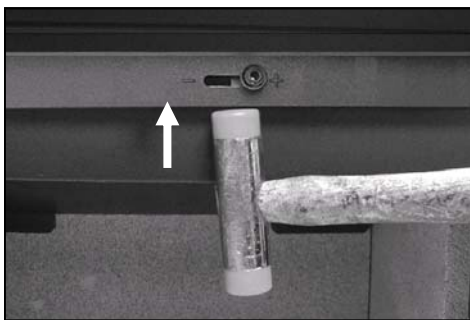

Fig. 5 Removing airwash assembly

ADJUSTING THE DOOR HINGES

Once the appliance has been under fire for a period of time the fire door may appear to have moved out alignment with relation to the door aperture or catch. This is quite normal and due to the settling of the casing.

The fire door can be re-aligned by user as follows:-

- When the appliance is cold, open the fire door so that it is at right angles to the front of the fire.
- Lift the fire door off its hinges (fig. 7)
- Gently tap the hinge pins in a direction to compensate for the misalignment (fig. 6)
- Refit the door and check to ensure it now sit square to the body, if not repeat above steps



Fig. 6 Adjusting Door Hinges

Fire Door Glass Replacement

In the event of the door glass being broken it can easily be replaced

- The door should be lifted off the hinges so that the above operation can be carried out on a workbench or similar level surface. This should be done when the appliance is cold (fig. 7)



Fig. 7 Removal of Stove Door

- Unscrew the two nuts on the inside of the door securing the retaining clips.
- Carefully remove any pieces of broken glass and sealing gasket wearing suitable gloves

Refit New Gasket

- The fitting of new gasket is shown below (fig. 8a)



Fig. 8a Fitting New Door Gasket

- Re-seat the new glass, ensuring the sealing gasket is flat and in contact with the glass



Fig. 8b Fitting New Glass

- Replace the two retaining clips and nuts. Do not over-tighten the nuts as damage may occur to the glass (fig. 8c)



Fig. 8c Tighten nuts

SERVICE & MAINTENANCE

Fire Door Rope Replacement

Periodically, visually check over the fire door rope seal for any damage, cuts or tears and any detached sections. The rope gasketing can be replaced, using the universal rope sealing kit (See spare parts, Page 22).

Please follow the instructions below:-

- Ensure the stove is cold and unlit
- Lift the door of the appliance and lay onto a flat surface with the rear face upwards.
- Carefully remove old rope gasket and old adhesive. Take note of the layout of the rope seal, ensure no traces of old adhesive, rust or flakey paint are present as this will result in an unsound joint.
- Apply the rope fixative following the instructions on the bottle.
- Press the rope gasketing into the channel on the rear of the door casting, following the same layout as the old rope seal. See fig. 8b
- Just before the final end, cut the rope seal to length and glue into position.
- Allow 30 minutes, before refitting the door to the appliance.

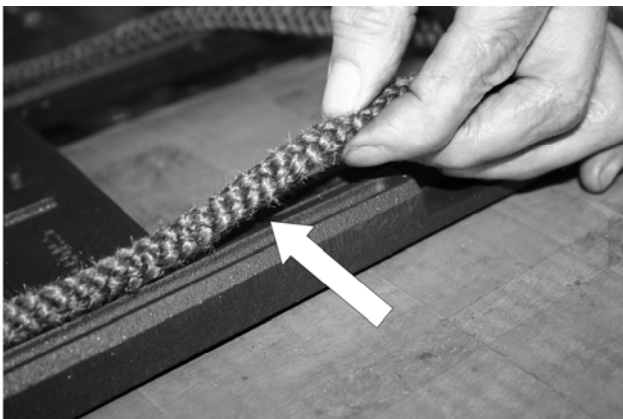

Fig. 8d Rope Replacement

OPERATING INSTRUCTIONS

Fuel Types

SAFETY NOTICE

The most efficient use of this appliance is with the fire door(s) closed at all times, apart from re-fuelling (when alight) or cleaning (when cold).

NEVER leave the appliance unattended for an extended length of time with the door(s) open. If this is the case, a spark guard must be used and the operating efficiency of the appliance will decrease.

WOOD— Any type of wood is suitable provided it is well seasoned and has a moisture content below 20%. This usually implies that the timber has been suitably stored to allow moisture to evaporate for at least nine months in the case of soft woods, and at least eighteen months in the case of hard wood. We recommend that for general burning, wood should be split into logs of no more than 100mm (4") diameter.

WARNING : wet wood must not be used as this will greatly contribute to the creation of tar and creosote which may, in extreme cases, run down the chimney in liquid form. This will seriously damage both the chimney and the appliance , and increase the risk of a chimney fire.

Please Note : If you have sticky tar inside the appliance or chimney your wood is 'Green' or too wet.

Please Note : The burn classification for all appliances in these instructions are classed as intermittent use.

Recommended Reading ;

"Wood as a fuel" available from the Forestry Commission.

PAPER— Paper will burn successfully. Burn dry paper only or chimney damage will occur.

WARNING : NEVER BURN PLASTICS OR HOUSEHOLD WASTE IN YOUR STOVE.

WARNING : NEVER BURN LIQUID FUELS IN YOUR STOVE.

PLEASE CONTACT : The Manufacturer For Further Details & Advice On The Use Of Other Fuels.

Note:

For additional further advise on fuels, please refer to HETAS, Tel 0845 634 5625 or www.hetas.co.uk and or Solid Fuel Association, Tel 0845 601 4406 or www.solid-fuel.co.uk

HETAS Approval only covers the use of wood on the appliance and does not cover the use of other fuels either alone or mixed with other fuels, nor does it cover instructions for uses of other fuels.

Lighting The Fire

Prior to lighting the stove for the first time, check with the installer that :

- Installation and all building work is complete.
- The chimney is sound and has been swept and is free from obstruction.
- Adequate provision for combustion air has been made, i.e. a permanent vent of at least 550mm sq per KW of rated output above 5KW, is fitted in the room in which the appliance is installed. Please note page 10, if the flue stabiliser is fitted to the flue.
- That Building Regulations and any local by laws have been followed during installation. See installation section of this manual.
- All firebox liner panels and throat plate are in place.
- That the chimney draw has been checked and is within specification. With the chimney warm, the draught should be between 1-2 mm water gauge or 0.1 to 0.2 mbar.

WARNING : An over drawing chimney can cause over firing, resulting in damage to the appliance.

ENSURE THAT YOU HAVE READ & UNDERSTOOD THESE INSTRUCTIONS BEFORE LIGHTING THE FIRE.

ALWAYS WEAR SUITABLE PROTECTIVE FIRE GLOVES WHEN REFUELLING YOUR STOVE.

OPERATING INSTRUCTIONS

Burning Wood

- Set the fire; by using rolled up newspaper and lay a layer of dry kindling wood on top of this.
- Use 2 or 3 fire lighters to light the kindling.
- Set the primary air and air wash controls to fully open position. See page 27.
- After the kindling has caught light, leave the fire door ajar by about 20mm. This will aid flue draw.
- The flue draw should be established after 5 minutes and the kindling will burnt down to form an ember bed.
- Carefully load the stove with well seasoned wood and close the fire door.
- After 10 to 15 minutes, regulate the air wash control, typically reduce to approximately half way.
- Similarly, reduce the primary air control, to the off position (-) as generally no air from below the grate is required when burning wood.

Please Note : The high temperature paint acquires durability by being “cured” during the initial firings of the appliance. It will give off fumes which are non toxic, but certain persons may find they have an unpleasant or irritant effect. Ensure that the surrounding area is well ventilated during this time.

Reduced Burning

Please Note : Classification of these appliances are for intermittent use.

Lower or reduced burn rates are possible by reducing the primary and secondary (air wash) air inlet controls to a lower setting. Please note if both controls are set on the minimum settings the appliance will be starved of air and die down.

WARNING : when wood is burnt slowly in a closed appliance, it produces moisture and tar, which will create condensation and deposits in the chimney. This effect can be minimised by burning hard for a short period, 15 to 20 minutes, twice a day.

Please Note : To avoid chimney problems your appliance should not be burnt at a reduced burn rate without a period of fast burning.

WARNING : *Properly installed, with a suitable flue or chimney and operated and maintained, this appliance will not emit fumes into the dwelling.*

Occasional fumes when de-ashing and re-fuelling may occur. However, persistent fume emission is potentially dangerous and must be investigated by a HETAS registered installer.

Stop using the appliance if you smell fumes or see smoke escaping.

If fume emission does persist, the following immediate actions should be taken :

- Open doors and windows to ventilate room.
- Let the fire die or extinguish and safely dispose of fuel from the appliance.
- Check for flue or chimney blockage, and clean if required.

Seek expert advice from your HETAS registered installer. Do not attempt to re-light the fire until the cause of the fume emission has been identified and corrected.

Ash Removal

The appliance will require ash to be removed periodically but an ash bed of approximately 20mm (3/4”) should be maintained. Ash may be removed with a small shovel whilst the fire is still lit by raking the embers of a low fire to one side of the firebox and carefully removing the ash, then repeating the procedure for the other side. Care must be taken not to risk burning of hands or household objects from falling embers.

Emptying the Ash Pan.

Open the fire door. Fit the fork end of the operating tool into the ash pan and remove from the ash pit chamber.

See fig. 9 (page 21) for information.

OVER FIRING & CHIMNEY FIRES

Do Not over fire your appliance. Using flammable liquids or too much wood or firing the stove at maximum for prolonged periods may result in over-firing. If the chimney connector or casing glows red the appliance is being over-fired this may result in a chimney fire. If this occurs :-

- Call the Fire Service - **Dial 999**
- Immediately close all of the air inlets to the appliance to reduce the air supply to the fire.
- Move items of furniture and combustibles away from the stove to reduce the risk of a fire and to allow access for the Fire Service.
- Ensure access to the loft space is available.
- Evacuate the property

A chimney fire may cause structural damage to the chimney, **DO NOT** use the appliance until the chimney and connector has been repaired or replaced. This should be done by a HETAS registered engineer.

MULTI PURPOSE OPERATING TOOL

Your **Arden** stove comes with a multi-purpose tool which is used to remove the ash pan (See Fig.9) Fit the fork end of the tool into the two slots in the ash pan rear face, ensure the forks are fully engaged to prevent an accident from occurring.

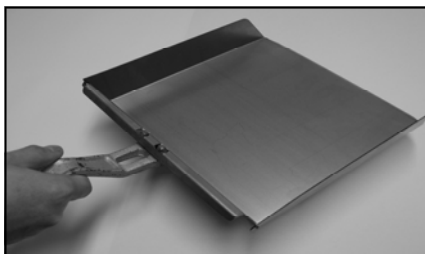

Fig. 9. Operating Tool & Ash Pan

AIR INLET CONTROLS

The **Arden** stove has two air inlet controls:-

- The air wash system (so called because pre-heated air washes across the inner face of the door glass keeping it clean) which provides over draught
- The primary air inlet, providing under draught to the base of the fire chamber through controls on the bottom of the stove door.

AIRWASH SYSTEM

The air wash has an internal sliding plate with slots, housed within the door casting and is located at the top of the door. Sliding the knob to the extreme right fully opens the air wash, sliding to the extreme left fully closes the air wash. (See fig. 10 & 11)

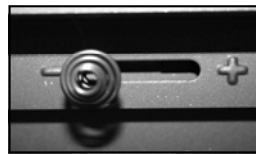

Fig. 10
Fully Closed

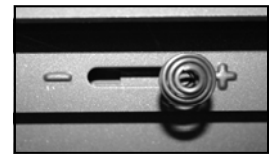

Fig. 11
Fully Open

PRIMARY AIR

Moving the knob to the right opens the internal slider allowing, air to enter the appliance. Moving the control to the left, closes the slider. This is useful when first lighting the fire as extra under draught air is required to establish the fire, but this control should be in the **closed** position when burning wood.



Fig. 12 Fully Open



Fig. 13 Fully Closed

SPARE PARTS LIST

Please Note: The serial number of your stove can be found stamped into the casing, centrally just below the bottom edge of the fire door aperture

Part Description & Visual Aid (not to scale)	Spare part Number	Part Description & Visual Aid (not to scale)	Spare part Number
1. Fuel grate 	AFS1078	12. Rope kit with glue 	AFS1021
2. Feet & Fixings 	AFS1079	13. Glass clips & Fixings 	AFS1010
3. Throat plate 	AFS1074	14. Glass kit with gasket 	AFS1075
4. Flue spigot 	AFS009A	15. Hinge kit with fixings 	AFS047
5. Hot plate 	AFGS064	16. Fire door complete 	AFS044
6. Ash pan 	AFS058		
7. Operating tool 	AFS008		
8. Rear Liners 	AFS1069		
9. Side Liners 	AFS1068		
10. Instructions 	AFS1080		
11. Airwash assembly 	AFS1077		

GUARANTEE

Your Valor Arden stove carries a guarantee against defects of manufacture and faulty workmanship for a period of one year from date of purchase. This does not apply to items which would be subject to fair wear and tear. Fire box liner panels, Fuel retainers, Throat plate, Door rope, Door glass and gaskets are not covered by the guarantee. However should you have any problems with your appliance please contact your Valor stockist who will have the knowledge and facilities to help you.

Valor will not be responsible for any consequential or incidental loss, damage, or injury however caused.

USE OF SPARE PARTS OTHER THAN THOSE SUPPLIED BY VALOR WILL INVALIDATE THE APPLIANCE WARRANTY.

All Guarantee periods commence on the date of purchase and are non-transferable. Our guarantee is offered as an addition to your statutory rights.

The guarantee is applicable to the original purchaser only and is non-transferable.

This installation and operating manual gives sufficient detail to enable the appliance to be installed and maintained. If further information is required, our **Valor Technical Helpline** will be pleased to help.

Please telephone: 08706 061 065 (local rates apply)

If you are calling from the republic of Ireland please phone 0044 08706 061 065

When you contact the helpline, they will need to know:-

1. Your Name, Address, Post Code and Telephone Number.
2. Date of Purchase and Supplier Details..
3. Name of Installer.
4. Stove Serial Number.
5. Clear and concise details of the Fault.

Please complete the following for you own records..

Date of purchase.....
Model..... Serial Number.....
Name and Address of Supplier.....
.....
.....
Name and Address of Installer.....
.....
.....

Final Factory Check list

Stove Model

Quality	
Finish	
Parts	
Flue Outlet	
Hot Plate	
Grate	
Firebox Liners	
Throat Plate	
Air Wash	
Door Catches	
Feet & Fixings	
Ash Pan	
Operating Tool	
Operating & Installation Manual	

*I've checked it
and its O.K.*

Assembled By.....

Checked by.....



Baxi Fires Division, Wood Lane, Erdington, Birmingham, B24 9QP
 Tel: 08706 061 064
 Fax: 0121 373 8181
 Email: www.fires&stoves.com