

Operating & Installation Manual



---

# Arley

## Wood & Multifuel Stoves



Arley 5 Flat Multifuel Stove

PLEASE RETAIN THESE INSTRUCTIONS FOR FUTURE REFERENCE

---

Rev 1  
June 2004

---

*Congratulations on your choice of an Arrow Stove.*

*More than 20 years experience has been put into the development of our Arley Family to ensure ultimate performance and years of trouble free enjoyment.*

*Every detail on the fire has been carefully engineered and designed which is why we are so confident in the reliability of our product that we offer a **3 year Warranty**.*

*Should you have any questions about our Arley Stoves that are not covered in this manual, please contact the Arrow dealer in your area, or call our Technical support department on  
01308 427234*

**© COPYRIGHT 2004**

Arada Ltd

This booklet has copyright & may not be copied in whole or part or be used for any purpose other than that for which it is supplied without express written consent from Arada Ltd.

---

## CONTENTS

---

<b>INTRODUCTION</b>	<b>Page</b>	<b>INSTALLATION</b>	<b>Page</b>
Safety Notices	5	General Precautions	16
The Principle of the Fire	5	Handling	16
Check List	6	Hearth	16
Technical Data	7	Combustible Materials	16
<b>OPERATING INSTRUCTIONS</b>		Firebox Liner Panels	17
Firebox Linings and Throat Plate Removal	8	Throat Plate Inspection	17
Airwash System	8	Assembling the Multifuel Grate	18
Multi-Purpose Operating Tool	9	Interchangeable Canopies	19
Fire Door Glass	9	Flues & Chimneys	20-23
Door Adjustment	10	Add In Boilers/Water Connections	24-25
Fuel Retainer Bars	10	Final Installation Check List	26
Fitting the Feet	10	Parts List	27-29
Fuel Types	11	<b>GUARANTEE</b>	
Lighting The Fire	11-12	3 Year Guarantee	30
Extended Burning	12	Customer Registration	30
Over Firing	13	<b>SERVICE RECORD</b>	
Ash Removal	13	Service Record	31
<b>SERVICING</b>		Final Factory Check List	32
Cleaning & Annual Maintenance	13-14		
Accessories	15		

---

**WARNING**

TO ALL MULTIFUEL USERS

**PETROLEUM COKE**

SOME OF WHOSE BRAND NAMES ARE

**"CALCO", "PETROCOKE" OR "WONDERCO"**

MUST NOT BE BURNED IN THIS APPLIANCE

TO USE THESE FUELS WILL INVALIDATE THE  
APPLIANCE GUARANTEE

**IF IN DOUBT CONTACT THE SOLID FUEL ASSOCIATION  
TELEPHONE NUMBER 0800 600 000**

[www.solidfuel.co.uk](http://www.solidfuel.co.uk)

**THE USE OF SPARE PARTS OTHER THAN THOSE SUPPLIED  
BY ARADA LTD WILL INVALIDATE THE  
APPLIANCE GUARANTEE.**

### SAFETY

A fireguard conforming to BS 8423: 2002 should be used in the presence of children and old/or infirm people. If the appliance is used with the fire door open, a spark guard conforming to BS 3248 should be fitted.

**Do not use aerosol sprays or any other flame near the appliance under fire.**

**Do not fit an extractor fan in the same room as the appliance.**

**Fire cement is caustic, hand and eye protection should always be worn, prolonged contact with the skin should be avoided.**

**Arada Ltd will not be responsible for any consequential or incidental loss or injury however caused.**

Before continuing any further with the installation of this appliance please read the following guide to manual handling.

- Always obtain assistance when lifting the appliance.
- When lifting always keep your back straight. Bend your legs not your back.
- Avoid twisting at the waist. It is better to reposition your feet.
- Avoid upper body/top heavy bending. Do not lean forwards or sideways when handling the fire.
- Always grip with the palms of your hands. Do not use fingertips for support.
- Always keep the stove as close to the body as possible. This will minimise the cantilever action.
- Use gloves to provide additional grip.

---

### THE PRINCIPLE OF THE FIRE

Your Aarrow Fire is built to the highest standard of craftsmanship using the best materials and the most modern equipment available. It is a highly efficient and sophisticated piece of machinery and when properly installed and operated it should provide a lifetime of heating satisfaction.

**Safety** is the most important consideration when installing your fire. If not properly installed and operated a house fire may result. Installation must comply with the Building Regulations and conform to all relevant fire safety standards.

Arada Ltd produce a variety of appliances ranging from units, which are traditional in style to stoves which are modern in appearance, all bristling with "High Tech" features.

Model types include simple room heaters, convectors, integral boiler models and inset units. Your Aarrow Fire is constructed from either single or twin wall steel strengthened where necessary. Cast iron is used where appropriate for decorative features.

All fire doors are fitted with special high temperature ceramic glass panels through which the fire can be viewed.

Multifuel stoves are fitted with a cast iron grate to give full multifuel facility and positive de-ashing.

All models except integral boiler models are lined with firebricks or heat reflective panels which ensure complete combustion and provide a good heat store to even out fluctuations in burning.

An internal throat plate produces turbulence to encourage secondary combustion and directs the flue gas around the whole upper firebox before allowing it to escape up the chimney.











On multifuel appliances the primary air for burning enters the ash pit chamber beneath the grate, controlled by the air inlet mechanism.

Aarrow Fires are also fitted with an "air wash" so called because it provides a curtain of high speed preheated air behind the glass to help keep it clean and to provide secondary air/over draught.

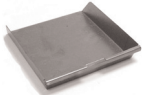
The provision of two inlets on all multifuel stoves gives a wide range of primary air/secondary air, under draught/over draught combinations.

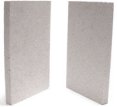
The optimum settings will only be established by experience in firing the appliance, and will depend on type of fuel, the position of the appliance in the house, condition of chimney etc.

## CHECK LIST

Part Description & Visual Aid (not to scale)	Arley 5 Wood	Arley 5 Multifuel	Arley 7 Wood	Arley 7 Multifuel	Arley 11 Wood	Arley 11 Multifuel
1. Grate bars 	N/A	5	N/A	7	N/A	9
2. Fuel retainers 	2	2	2	2	2	2
3. Throat plate 	1	1	1	1	1	1
4. Flue spigot 	1 (4")	1 (4")	1(5")	1 (5")	1 (5")	1 (5")
5. Hotplate 	1 (4")	1 (4")	1(5")	1 (5")	1 (5")	1 (5")
6. Ashpan 	1	1	1	1	1	1
7. Operating tool 	1	1	1	1	1	1
8. Rear liner 	1	1	2	2	2	2
9. Side liners 	2	2	2	2	2	2
10. Feet and fixings 	4	4	4	4	4	4
11. Optional woodburning tray 	1	optional accessory	1	optional accessory	1	optional accessory
12. Multifuel riddling kit 	optional accessory	N/A	optional accessory	N/A	optional accessory	N/A
13. Instructions	1	1	1	1	1	1

## TECHNICAL DATA

TECHNICAL DATA	Arley 5 Wood	Arley 5 Multifuel	Arley 7 Flat	Arley 7 Low	Arley 7 High	Arley 11 Flat	Arley 11 Low	Arley 11 High
Room Min/Max Room Heater Only Output (kW)	1 - 5	1 - 5	1 - 7	1 - 7	1 - 7	1 - 11	1 - 11	1 - 11
Room Heater with Domestic Hot Water with add in boiler <b>type</b>	0	0	8	8	8	9	9	9
Max Output to Room (kW)	3	3	4.8	4.8	4.8	8.7	8.7	8.7
Max Output to Water (kW)	2	2	2.2	2.2	2.2	2.3	2.3	2.3
Height (mm)	497	497	510	680	745	557	736	825
Width (mm)	405	405	486	486	486	611	611	611
Depth (mm)	358	358	365	365	365	375	375	375
Height to Centre of Rear Flue	400	400	399	396	396	442	442	442
Depth from Back to Centre of Flue (mm)	105	105	121	109	109	130	106	106
Flue Diameter	102 (4'')	102 (4'')	127 (5'')	127 (5'')	127 (5'')	127 (5'')	127 (5'')	127 (5'')
Weight Packed (Kg)	47	50	56 Wood 59 MF	62 Wood 67 MF	63 Wood 68 MF	64 Wood 67 MF	74 Wood 78 MF	75 Wood 79 MF

## OPERATING INSTRUCTIONS

### FIREBOX LININGS & THROAT PLATE

The Arley Wood and Multifuel stoves firebox have reflective liners to the sides and rear and a specially shaped throat plate which sits on the liners. If these are not in place please refer to page 17 to install these.

### MULTIFUEL GRATE

The Aarrow Multifuel grate comprises of a series of reciprocating cast iron bars seated on a pivoted "comb". These should come fitted in your stove, if not please refer to page 18 for fitting and operation and also operating instructions on fuels for correct settings of the grate. The multifuel grate is fully interchangeable with the wood burning tray if you prefer to burn wood only.

### WOOD STOVE -WOOD TRAY

The wood burning tray should come fitted in your stove, if not please follow these instructions; place the wood burning tray inside the fire, locating the rear lugs into the slots at the rear of both of the side landings. Then lower the front of the tray into the holes at the front of the fire (See Fig.1)

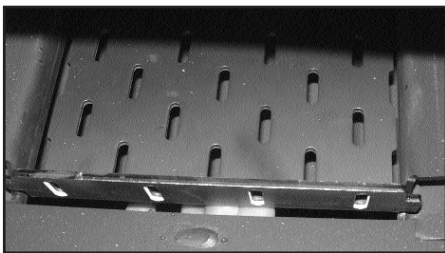

Fig. 1

### AIR INLET CONTROLS

Arley multifuel stoves have two air inlets:

- The air wash system (so called because its pre-heated high speed air washes across the inner face of the door glass, keeping it clear), which provides over draught, and
- The primary air inlet providing under draught to the base of the fire chamber through the controls on the doors of the fires.

### PRIMARY AIR FOR ARLEY STOVES

On the Arley, primary air enters the appliance through the controls on the bottom of the fire door(s). Moving the control knobs to the right will increase the air inlet, to the left to reduce the air inlet, or to seal the ash door completely.

### AARROW AIRWASH SYSTEM

The air wash has an internal sliding plate with slots, housed in a cover plate, and is located above the fire door. Sliding the control knob to the right as far as it will go achieves the fully open position. Sliding it to the left will shut off the air inlet slots as shown in Fig. 2a and Fig. 2b.



Fig. 2a Fully closed



Fig. 2b Fully open

Even when all the slots are completely shut a "bleed" of secondary air will be maintained ensuring that inflammable gases are burnt off.

### DISASSEMBLE AIRWASH

The Arley air wash may be disassembled for cleaning or adjustment. To achieve this, the following procedure should be followed:

*This should only be carried out when the fire is cold and unlit.*

- Support Air Wash cover with one hand.
- Move cover up by smartly tapping the bottom with a hammer. (Fig. 3)
- Remove assembly from appliance.
- Clean and/or adjust.
- Refit using reverse procedure.

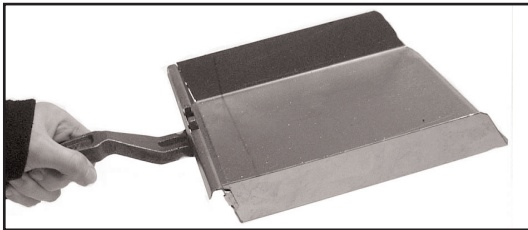

Fig. 3 Disassemble airwash



### MULTI - PURPOSE OPERATING TOOL

Your Aarrow fire comes with a multi-purpose tool, which is used for riddling, setting the multifuel grate position. Use the operating tool for setting the grate in the coal burning position or the wood burning position. This lever is also used for de-ashing and riddling see page 13 (multifuel stoves only) and for emptying the ash pan. (Fig. 4)



**Fig. 4 Operating tool and ashpan**

### FIRE DOOR GLASS

In the event of the door glass being broken it can easily be replaced. This should be done when the appliance is cold and unlit:

- The door(s) should be lifted off the hinges so that the below operations can be carried out on a workbench or similar level surface. (Fig.5)



**Fig. 5 Removal of the Arley 5 door**

- Unscrew the two nuts, on the inside of the door securing the retaining clips.
- Carefully remove any pieces of broken glass, and sealing gasket wearing suitable gloves.

- Re-place the gaskets and line them up in relation to the door frame. (Fig.6)

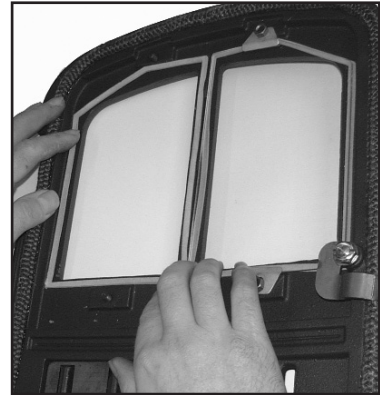

**Fig. 6 Lining up the gasket**

- Re-seat the new glass, ensuring the sealing gasket is flat and in contact with the glass. (Fig.7)

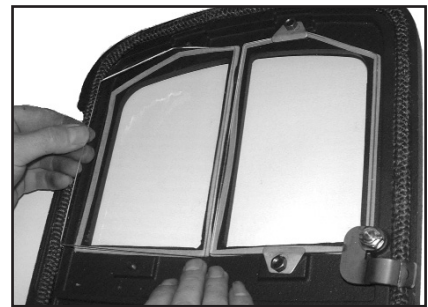

**Fig. 7 Fitting door glass**

- Replace the two retaining clips and nuts. Do not over-tighten the nuts as damage may occur to the glass (Fig.8) Re-place the door(s) carefully over the hinges and slot in place.

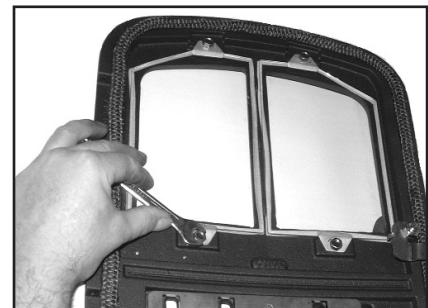

**Fig. 8 Tightening glass clips**

## OPERATING INSTRUCTIONS

---

### DOOR ADJUSTMENT

Once the appliance has been under fire for a period of time the fire door may appear to have moved out of alignment with relation to the door aperture. This is quite normal and due to the settling of the casing.

The fire door can be re-aligned by the user as follows:

- When the appliance is cold, open the fire door so that it is at a right angle to the front face of the fire.
- Lift the fire door up off the hinges.
- Gently tap the two hinge pins in a direction to compensate for the misalignment.(fig 9)
- Refit the door and check to ensure it now sits square to the body; if not repeat above steps.



**Fig. 9 Adjusting the Arley hinges**

### FUEL RETAINER BARS

Fuel retainer bars are supplied with the fire. Slide and lift the bar until it is clear of the guides at each side, and remove through the fire door opening. The bars are symmetrical and of even lengths making incorrect fitting impossible.

*Note: This operation should only be carried out when the appliance is cold and unlit.*

### FITTING THE FEET

The Arley wood and multifuel stoves must be fitted with the feet supplied.

Care should be taken whilst assembling the feet so as not to damage the painted surface of the fire.

- The feet are positioned in each corner of the fire and fixed using the washers and screws provided.
- You will need a no. 2 pozidrive screwdriver to tighten the screws.***

### FUEL TYPES

**Wood-** Any type of wood is suitable provided it is well seasoned and has a moisture content below 20%. This usually implies that the timber has been suitably stored to allow moisture to evaporate for at least nine months in the case of soft woods, and at least eighteen months in the case of hard wood. We recommend that for general burning, wood should be split into logs of no more than 130mm (5") diameter.

Larger logs can be used for overnight burning.

**WARNING** wet wood must not be used as this will greatly contribute to the creation of tar and creosote which may, in extreme cases, run down the chimney in liquid form. This will seriously damage both the chimney and the appliance, and increase the risk of chimney fire.

*Note: If you have sticky tar inside the appliance or chimney your wood is 'Green' or too wet.*

#### **Recommended Reading:**

"Wood as Fuel" available from the Forestry Commission.

**Peat-** Can be used in turf or briquette form, but again the moisture content must be low.

**Paper-** paper will burn successfully. Burn dry paper only or chimney damage will occur.

### **NEVER BURN PLASTICS OR WASTE IN YOUR STOVE.**

**Coal** - Household coal produces a large amount of ash and smoke. If used the appliance and chimney will require frequent cleaning. Therefore soft house coal is **not** recommended.

#### **Recommended fuels are as follows:**

*The Hetas Ltd, "Three Tick" appliance approval only covers the use of the following fuels in this appliance; Phurnacite, Phurnacite Plus, Centurion, Maxibrite, Extracite, Pureheat, Blazeprite, Taybrite, Sunbrite (Doubles/Singles), Anthracite (Large Nuts), and Welsh Dry Steam Coal (Large/Small Nuts).*

*Approval does not cover the use of other fuels either alone or mixed with the suitable fuels listed above, nor does it cover instructions for the use of other fuels. For latest details please refer to Hetas website [www.hetas.co.uk](http://www.hetas.co.uk).*

**Do not use smaller sizes than Stovesse, e.g. Beans, Peas, Grains.**

**Do not use petroleum based solid products such as Calco or Petrocoke.**

**To do so will invalidate the appliance guarantee**

---

### LIGHTING THE FIRE

**Prior to lighting the fire for the first time check with the installer that:**

- Installation and all building work is complete.
- The chimney is sound and has been swept and is free from obstruction.
- Adequate provision for combustion air has been made, i.e. a permanent vent of at least 550mm<sup>2</sup> per kW of rated output above 5 kW, is fitted in the room in which the appliance is installed.
- That Building Regulations and any local by-laws have been followed during installation (see installation instructions).
- All firebox liner panels are in place.
- Throat plate is in place.
- Where add in boilers are fitted ensure that the system is full of water and vented, and precautions have been taken to prevent corrosion (see installation Instructions).
- That the chimney draw has been checked and is within specification. With the chimney warm the draught should be between 1 - 2mm water gauge (0.1 - 0.2mbar).

**WARNING:** An over drawing chimney can cause over-firing resulting in damage to the appliance.

**WARNING - ADD IN BOILERS:** Do not light the fire if it is suspected that any part of the water system is frozen.

## OPERATING INSTRUCTIONS

---

**ENSURE THAT YOU HAVE READ & UNDERSTOOD THESE INSTRUCTIONS BEFORE LIGHTING THE FIRE.**

**ALWAYS WEAR SUITABLE PROTECTIVE FIRE GLOVES WHEN REFUELLING YOUR STOVE.**

### SOLID FUEL BURNING

- Set the grate to 'coal' position.
- Ensure that the ash pan is in position and the fire doors are closed.
- Set the air wash to one quarter open position.
- Set the primary inlet to the fully open position
- Light in the normal manner with paper and kindling, or use a fire lighter.
- If using a gas poker be sure to remove it immediately the fire is alight.
- When the fire is well alight regulate the burning rate by adjusting the setting on the primary air inlet control.
- The air wash can be opened sufficiently to keep the door glass clean

### BURNING WOOD

- Set air wash to fully open position.
- Proceed as for solid fuel but note the fire will burn up and become established more quickly.

### MIXED FUELS

- As per coal but allow additional secondary air.
- The primary air inlet can be closed and burning regulated by means of the air wash above the door.

### ANTHRACITE

Anthracite is more difficult to keep in for long periods, consequently more care in setting the controls and some familiarisation is necessary when burning anthracite.

Use the smallest size fuel (Stovesse or Small Nuts). Proceed as for manufactured smokeless fuel. Leave the air inlet control open about a quarter or less.

*Note: The high temperature paint acquires durability by being "cured" during the initial firings of the appliance will give off fumes which are non-toxic, but which certain persons may find have an unpleasant or irritant effect. Ensure that the area is well ventilated during this time.*

### EXTENDED BURNING

**The appliance will burn for an extended period provided:**

- Sufficient fuel is placed in the firebox.
- The controls are set correctly.
- Excess draught is not present in the chimney.
- Close the door.
- If the fire goes out with unburnt fuel left in the firebox increase the air opening slightly, and vice versa.

#### In the morning

Open the air control fully until embers begin to glow brightly and place pieces of fuel on the fire until it is well established.

**WARNING:** When wood is burnt slowly in a closed appliance it produces moisture and tar, which will create condensation and deposits in the chimney. This effect can be minimised by burning hard for a short period, about 20 minutes, twice a day. It is usually convenient to do this morning and night.

**Note: To avoid chimney problems your fire should not be burnt slowly for longer than 12 hours without a period of fast burning.**

**WARNING: Properly installed, with a suitable flue and chimney and operated and maintained this appliance will not emit fumes into the dwelling. Occasional fumes from the de-ashing and re-fuelling may occur. However, persistent fume emission is potentially dangerous and must be investigated by a Hetas registered installer.**

**Stop using the appliance if you smell fumes or see smoke escaping.**

If fume emission does persist, the following immediate actions should be taken.

- Open doors and windows to ventilate room.
- Let the fire die or extinguish and safely dispose of fuel from the appliance.
- Check for flue or chimney blockage, and clean if required.

*Seek expert advice from your HETAS registered installer. Do not attempt to re-light the fire until the cause of the fume emission has been identified and corrected.*

### **ASH REMOVAL Wood burner only**

Ash will drop through the holes and to the slides of the specially designed wood tray. This should be removed from the stove periodically. It is advisable to leave a layer of ash on the wood tray to prolong its life and maintain optimum conditions for burning wood.

### **ASH REMOVAL - Multifuel Stoves only**

The ash pan should be emptied at least twice a day or when the level of ash reaches the top of the ash pan. On no account should the ash be allowed to build up to touch the grate as this will greatly shorten its life.

### **DE - ASHING - Multifuel Stoves only**

It is necessary to maintain an ash layer on the upper surface of the grate bars, in order to protect them so de-ashing should cease as soon as the first red embers drop into the ash pan. Further de-ashing will cause heat build-up under the grate, which will considerably shorten its life. This operation should be carried out with the doors closed to prevent dust escaping into the room.

- Move up and down vigorously the riddling lever (ash will fall into the ash pan beneath the grate).
- When de-ashing is complete re-set grate to previous position.
- Empty the ash pan.

*Note: Do not force the riddling lever.*

### **TO EMPTY THE ASH PAN**

Open the fire door. Fit the fork end of the operating tool into the ash pan and remove from the ash chamber.

**WARNING:** The ash can be very hot. Empty only to a metal container. Even if the ash appears cold, red-hot pieces of ash may be concealed and could easily start a fire or cause an injury. Replace the ash pan and close the fire door.

### **CLINKER**

The formation of clinker suggests that the unit is being over-fired. Any clinker forming on the grate should be removed when cold.

### **OVER-FIRING**

**Do not** over fire your appliance. Using flammable liquids or too much wood or firing the fire at maximum for prolonged periods may result in over-firing. If the chimney connector or casing glows red it is being over-fired. If this occurs immediately close all air inlets to the appliance to reduce the air supply to the fire. Should a chimney fire occur immediately close the appliance down. Get everyone out of the house and call the fire brigade. A chimney fire may cause structural damage of the chimney. Do not use the appliance until the chimney and connector have been inspected and any damaged parts repaired or replaced. This should be done by a competent person such as a HETAS registered engineer.

### **CLEANING IMPORTANT**

Under some circumstances soot can quickly build up on the throat plate and adjacent areas. The throat plate should be removed and checked monthly, and any debris stripped off. Similarly, clean the upper surface of the firebox.

Refer to page 17 for instructions on throat plate removal/inspection.



## SERVICING

---

### ANNUAL MAINTENANCE

*It is important that your fire is regularly serviced in accordance with these instructions. This should be carried out at least annually by a qualified person and should consist of the following.*

Remove the firebricks lining and throat plate, inspect all gasketing on doors, glass etc., and re-order any items that may need replacing, from your Aarrow dealer. With a wire brush clean inside the appliance paying particular attention to the small inlet holes of the air wash on the inside, above the fire door and to the door.

Sweep the chimney and confirm that it is sound. Examine all joints in the flue pipe etc., and re-seal if necessary. Reassemble and leave with the air inlet and air wash control about half way open. This will allow a free flow of air through the appliance thus preventing moisture and condensation from building up inside the fire and chimney.

### CHIMNEY SWEEPING

Sweeping should be carried out with an appropriate sized bristle brush and rods to suit chimney size and type. As with all appliances regular sweeping of the flue is essential to avoid the danger of blockage and the escape of poisonous fumes. Access for cleaning should also be incorporated in the chimney (e.g. soot door or access through register plate).

Any existing chimney should be swept prior to installation of the appliance, and swept again a second time **within one month** of regular use after installation to establish frequency of sweeping required. This should be done by a competent person such as a NACS chimney engineer who will provide a Certificate of Chimney Sweeping.

Sweep the whole flue way, including the outlet, at least twice per burning season. It is important that the flue ways, flue pipe and chimney be cleaned prior to lighting the fire after a prolonged shut-down period.

### DOOR GLASS

The door glass should remain clear during normal daytime burning. However under certain conditions—such as burning at a low rate with damp wood, or overnight

burning, the glass may become somewhat blackened. To remedy this, operate the appliance at a fast rate. Alternatively when the stove is cold open the door and clean the inside face of the glass with a damp cloth or with glass cleaner (available from fire stockists). A piece of cloth moistened with vinegar and dipped in wood ash - **not coal ash** - will provide a good soft scourer to remove the soot without scratching the glass.

### OUTER FINISH

The outside finish of the appliance is a durable high temperature paint. It is best cleaned by brushing down with a clean shoe brush. Do not allow moisture to remain on the appliance whilst cold or surface rust may form.

The high temperature paint should not require attention for some time, depending on use. The hotter the fire burns the sooner repainting will be necessary. Aerosol tins of paint are available for complete refurbishing. Before repainting make sure that the fire is out and is cold.

- Remove the door glass.
- Lightly wire brush, or rub with wire wool, the body of the appliance to remove any loose paint powder.
- Mask or remove items such as brass work.
- Any adjacent brickwork, mantelpiece, hearth, etc., should be carefully masked for quite a distance around the appliance. (this precaution is to prevent discolouration of the surrounding brick work, wallpaper etc).

**Re-spray in a well-ventilated area - avoid breathing the vapour. Refer to safety instructions on paint cans.**

- When the paint is dry refit door glass and any other parts previously removed.
- Leave the appliance for eight hours before re-lighting.
- Burn slowly for the first four hours, then build up heat gradually to cure the paint.

**Note: Use only genuine Aarrow touch-up spray as some paints interact. This could ruin the finish and invalidate the guarantee.**

## ACCESSORIES

### WOOD BURNING TRAYS

To turn your multifuel stove into a dedicated woodburner. As shown in Fig. 10a below



Fig. 10a

### MULTIFUEL UPGRADE KIT

Available for the wood burning range to enable you to burn solid fuel in your Arley wood stove. (See Fig 10b)

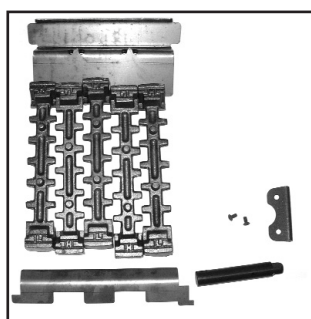

Fig. 10b

### ADD IN BOILERS

ADD IN BOILER TECHNICAL DATA	Arley 5 Wood & Multifuel	Arley 7 Wood & Multifuel	Arley 11 Wood & Multifuel
Room Heater with Domestic Hot Water with add in boiler <b>type</b>	<b>0</b>	8	9
Max Output to Room (kW)	3	4.8	8.7
Max Output to Water (kW)	2	2.2	2.3

See page 24 for further instructions on add in boilers.

### PAINT

Matching aerosol paint to tone in any connecting flues, pipes or surrounding metalwork.

# INSTALLATION

---

## GENERAL PRECAUTIONS

*Note - All installations must conform to the appropriate building regulations.*

The Building Regulations for England and Wales 2000 ref Approved Document J 2002 edition (issued by the DTLR).

The Building Standards (Scotland) (Consolidation) Regulations.

Detailed recommendations for installation of appliances, chimneys and flues are outlined in the current issue of the following British Standards:- BS6461, BS8303 and BS4543.

*Any Manufacturer's Instructions must not be taken as overriding statutory requirements.*

During installation ensure that adequate precautions are taken to avoid unnecessary risk to yourself or any householder. In particular the danger from the caustic nature of the fire cement should be avoided by using these accepted methods:

- Wear gloves when handling fire cement.
- Wear goggles when chiselling or looking up chimneys.

Make sure that Building Regulations are adhered to during installation along with any local by-laws. In the case of heating systems make sure that the pipe work is correctly bonded to ensure electrical earthing.

## HANDLING

By the time you read this you will appreciate the weight of the appliance. The Safety and handling guidelines as set out on page 5 of this manual should be followed.

To make movement easier internal fittings, fuel retainers, grates, firebox liners, flue outlets, hot plate, throat plate, etc., can be removed.

Care should be taken to make sure that the hinges are not damaged during installation.

## HEARTH

The fire should be installed to stand on a constructional hearth of non-combustible materials not less than 125mm (5") thick conforming to Building Regulations. Dimensions of the hearth should project at least 300mm (12") forward of the front of the appliance and 150mm (6") at the sides. The surface of the hearth should be free of combustible materials. In most buildings with solid concrete floors the requirement will be met by the floor itself, but mark the perimeter of the hearth to ensure floor coverings are kept well away or use different levels to mark the hearth perimeter.

## COMBUSTIBLE MATERIALS

A gap of at least 450mm (18") should be allowed between the appliance and any combustible materials including furnishings. Adjacent walls should be of suitable non-combustible construction, preferably brickwork. In large fireplaces take care that any supporting beam is protected by a 13mm (0.5") sheet of Masterboard/Supalux spaced 13mm (0.5") off the surface with strips of non-combustible material - not wood.

Make sure that there is a gap between an uninsulated flue system and any combustible material. This gap must be at least 3 x the outside diameter of the flue pipe, or 1.5 x the flue diameter to non combustible surfaces. see illustration p22.

## AIR FOR COMBUSTION

There must always be a permanent means of providing air for combustion into the room in which the fire is installed. A permanent vent with a total free area of at least 550mm<sup>2</sup> for every kW rated output above 5kw should be connected directly to the outside air or to an adjacent room which itself has a permanent vent of the same size direct to the outside air. The fitting of an extractor fan to either of these rooms is not recommended.



## FIREBOX LINER PANELS

The Arley Wood and Multifuel stoves use reflective liners to the sides and back. The throat plate sits on top of the side and rear panels. These should come fitted to your fire, if however they are not proceed as follows to fit them.

- Remove the front fuel bars or multifuel grate.
- Set the small liners into the back of the fire.
- Insert side liner panels
- Fit the throat plate with the single bend and two cut outs to the front facing up. The projecting lugs sit on top of the side liners. The long centre tab on the back edge rests on the rear liners. The shorter turn-down tabs against the vertical face.
- Replace the front fuel retainer bars or multifuel grate.

*Note: Neither the rear firebox liners nor the side firebox liners are "handed", both faces are suitable for direct contact with the fire.*

*Note: Cracking of lining panels does not effect efficiency.*

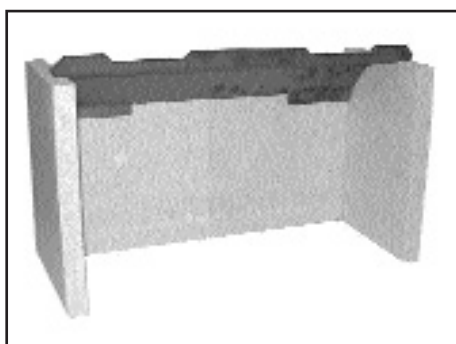

**Fig. 11** *Arley 11 multifuel liners and baffle.*



**Fig. 12** *Liners inserted in Arley 11 multifuel.*

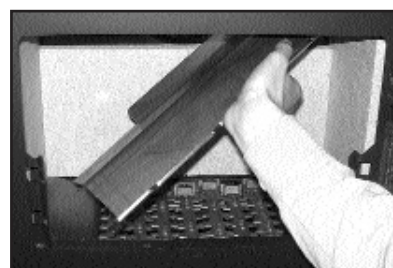

**Fig. 13** *Inserting Throat Plate in to Arley 11 multifuel.*

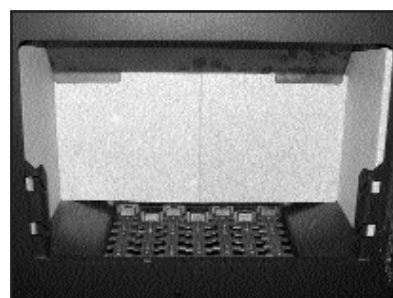

**Fig. 14** *Liners, throat plate and grate in Arley 11 multifuel.*

## REMOVAL OF THE THROAT PLATE

Blocked chimneys cause dangerous fumes to escape. Remove throat plate at least monthly to clean. Keep chimney and flue ways clear.

# INSTALLATION

---

## MULTIFUEL GRATE

### GRATE

The grates in the Arley Multifuel units comprise a series of reciprocating cast iron bars seated on a pivoted "comb". All bars in the grate are identical, but every other bar is turned through 180 degrees, with the ends of the bars marked "H" sitting on the high sections of the comb, and the ends marked "L" sitting on the low sections.

### ASSEMBLING THE GRATE

To assemble the grate, fit bars to low sections of the comb first, inserting end marked "H" into rear channel with groove on underside of bar located on upstand tab, and then lowering end marked "L" onto the low section of the comb. The upper bar is fitted in a similar manner, but with the end marked "L" inserted in the rear channel, and the end marked "H" seated on the high section of the comb.

### GRATE BAR REPLACEMENT

After extended use it may be necessary to replace some of the grate bars. Periodic inspection of the bars is recommended and the removal of any nails or wire that may be present after burning wood.

All the grate bars in each appliance are identical and can easily be lifted out after removal of the fuel retainers. Remove damaged grate bars and replace with casting of the same type, fitting as per instruction above. (Check Identification letters on the casting when reordering).

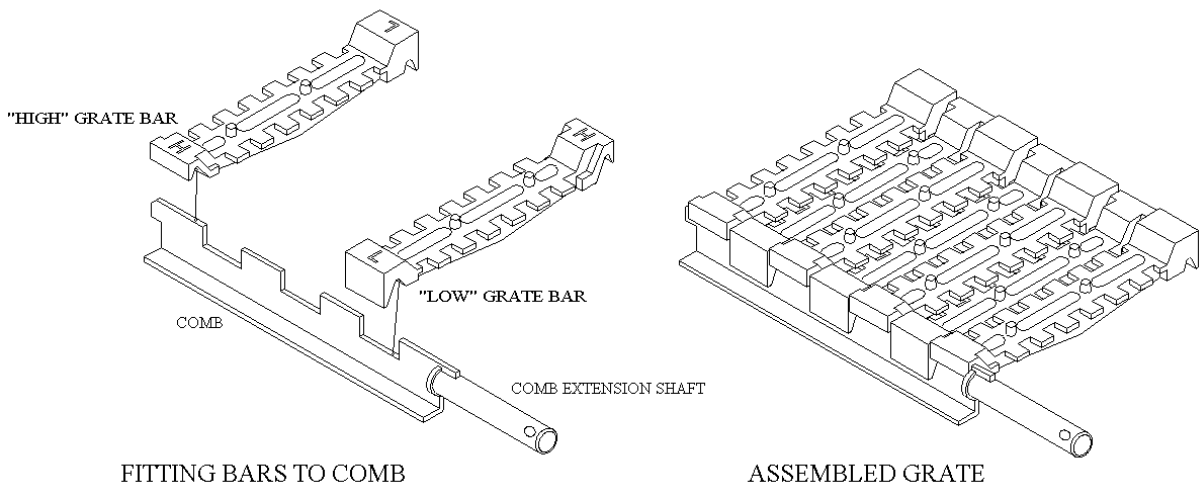

## INTERCHANGEABLE CANOPIES

The canopy versions for the Arley 7 & 11 range is a flat top stove to which a low or high canopy can be fitted after installation and are interchangeable.

These are fitted as follows:

- To fit the interchangeable canopy (Fig 10c):
- Remove the front clamps.
- Tilt the canopy as shown in stage 1.
- Engage the rear clips and pull fully forward.
- Fit the front clamps and tighten.

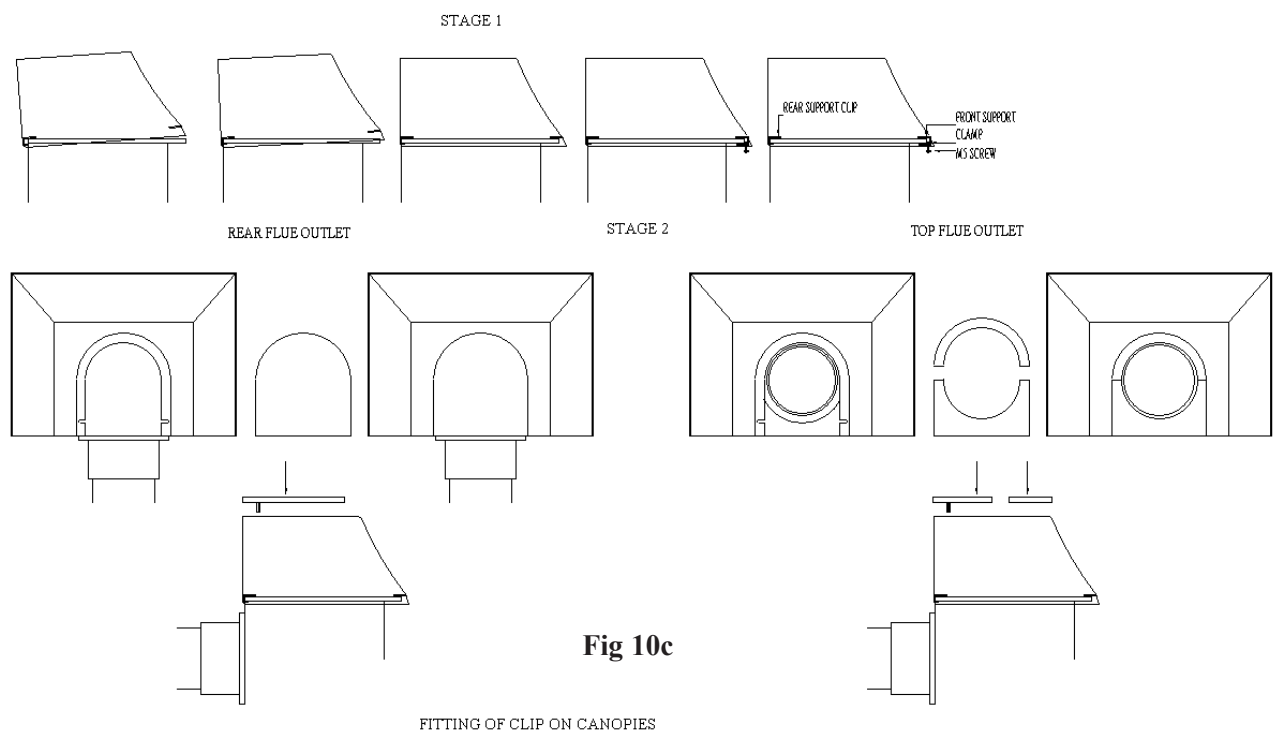

## INSTALLATION

---

### FITTING THE FLUE OUTLET AND HOT PLATE

The flue outlet spigot is found inside the appliance. The hot plate (blanking plate) is supplied fitted to the top opening and is removed by turning clockwise (as is the flue outlet).

Smear a very thin layer of fire cement on the faces of the flue outlet and the blanking plate. Fit the outlet to the appliance in the desired position.

Lock into place by rotating anti-clockwise and tighten by tapping with a block of wood and mallet from the inside of the appliance. Similarly, fit the blanking plate to the unused opening. Clean off any surplus fire cement.

Place appliance on the hearth and make sure that it is level and does not rock.

Connect the chimney ensuring all joints are sealed with fire cement.

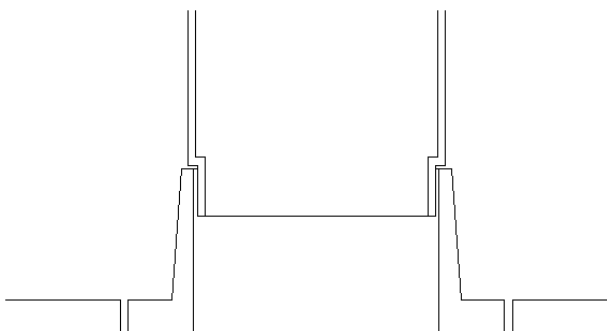

\*NOTE

THE FLUE PIPE MUST BE FITTED INSIDE THE OUTLET SPIGOT  
FAILURE TO DO SO COULD RESULT IN THE SPILLAGE OF  
CONDENSATION ETC. RUNNING DOWN THE FLUE.

**Fig. 15 Flue and Spigot Fitting**

### FLUES AND CHIMNEYS

Please remember that chimney draught is dependent on four main factors:

- Flue gas temperature.
- Flue height.
- Flue size.
- Flue terminal.

The stove must be connected to a suitable and efficient flue that provides a good updraught to safely take the products of combustion (fumes) from the stove outlet to the outside air. To ensure a good updraught it is important that the flue gases are kept warm and that the flue size suits the stove.

The termination of the outlet at the top of the flue also needs to comply with the Building Regulations. The minimum effective height of the flue must be at least 4.5 metres from the top of the stove to the top of the flue outlet. When warm the flue draught should be between 0.1 and 0.2 mb.

A chimney may comply with the regulations but still be subject to down draught and similar problems. A chimney terminating above the ridge level is generally less likely to suffer such problems.

If a new chimney is being provided it should fully comply with the relevant Building Regulations that specify the requirements for solid fuel burning installations. Suitable types of chimney include the following.

**Masonry chimney** built with clay or concrete liners, or a chimney block system meeting Building Regulations. These types of chimney should be installed in accordance with the Building Regulations and BS 6461: Part 1.

**Factory made insulated chimney** complying with BS 4543: Part 2 (often called "Class 1 prefabricated metal chimney"). These types of chimney should be installed in accordance with the Building Regulations and BS 7566: Parts 1 to 4.

Due to the gradual introduction of European Chimney Standards chimneys will be specified according to their performance designation as defined in BS EN 1443 that covers the General Requirements for chimneys. The minimum performance designation required for use with solid fuel burning stoves is T450 N2 S D3.

The flue and chimney installation must be carefully checked by a competent person before fitting the stove to ensure it is suitable and will work safely.

If the chimney is old (ie built of brick or stone without a liner) or being opened up for reuse additional checks and smoke testing as described in Appendix E of the Approved Document J 2002 Edition should also be carried out to ensure the flue and chimney are in good operating condition.

Unless the existing flue is in good condition with suitable access for collection and removal of debris. If the flue size is more than 225mm (9 inches) diameter or 200 x 200mm square, a suitable lining of 150mm (6 inches) diameter should be fitted, or if the flue length is over 5.5 metres one size larger than the appliance outlet should be fitted. This should be a double skin stainless steel flexible flue liner that is independently certified for use with solid fuel. Details of suitable linings for use with solid fuel are given in the Official HETAS guide that can be viewed on their website at [www.hetas.co.uk](http://www.hetas.co.uk)

It is also important that suitable flue pipe complying with the Building Regulations is used to connect the stove to the flue in the chimney and that suitable access is provided into the flue for regular inspection and sweeping of the flueways.

The installer should comply with the Building Regulation requirements in respect of providing a Notice Plate giving details on the chimney, flue lining, hearth and fireplace installation. Approved Document J of the Building Regulations for England and Wales is available from The Stationery Bookshops and can also be viewed at the ODPM website at [www.safety.odpm.gov.uk/bregs/brads.htm](http://www.safety.odpm.gov.uk/bregs/brads.htm)

Details on the relevant Building Regulations and BS British Standards are given in the "General

Precautions" section page 16 of these instructions. A chimney may comply with the regulations but still be subject to down draught and similar problems. A chimney terminating above the ridge level is generally less likely to suffer such problems.

Chimneys should be as straight as possible. Horizontal runs should be avoided except where the rear outlet of the appliance is used, in which case the horizontal section should not exceed 150mm (6") in length.

If the fire appears to be working hard but produces very little output to the room it is likely that excessive draw is present in the chimney, and that heat is being sucked out of the appliance and up the chimney. If this is the case we recommend the fitting of a draught stabiliser in preference to a flue damper, in the interest of safety and efficiency.

We do not recommend the use of a damper when burning solid fuel.

### **FOR ALL APPLIANCES**

Access for cleaning the flue should be incorporated in the system other than through the appliance (e.g. a soot door or access through register plate). Purpose-made soot doors and inspection lengths are available from manufacturers of all systems.

Ensure that the whole length of the flue can be reached from the soot door.

*Note: if the appliance is fitted with a draught stabiliser or if one is fitted to the flue pipe or chimney in the same room as the appliance, then the permanent air entry opening (or openings) should be increased by 300mm<sup>2</sup> for each kW of rated output.*

**For advice on flues and chimneys contact;**  
**NACE (National Association of Chimney Engineer): telephone 0800 0924019**  
**[www.nace.org.uk](http://www.nace.org.uk)**  
**or**  
**NACS (National Association of Chimney Sweeps): telephone 01785 811732**  
**[www.chimneyworks.co.uk](http://www.chimneyworks.co.uk)**

# INSTALLATION

---

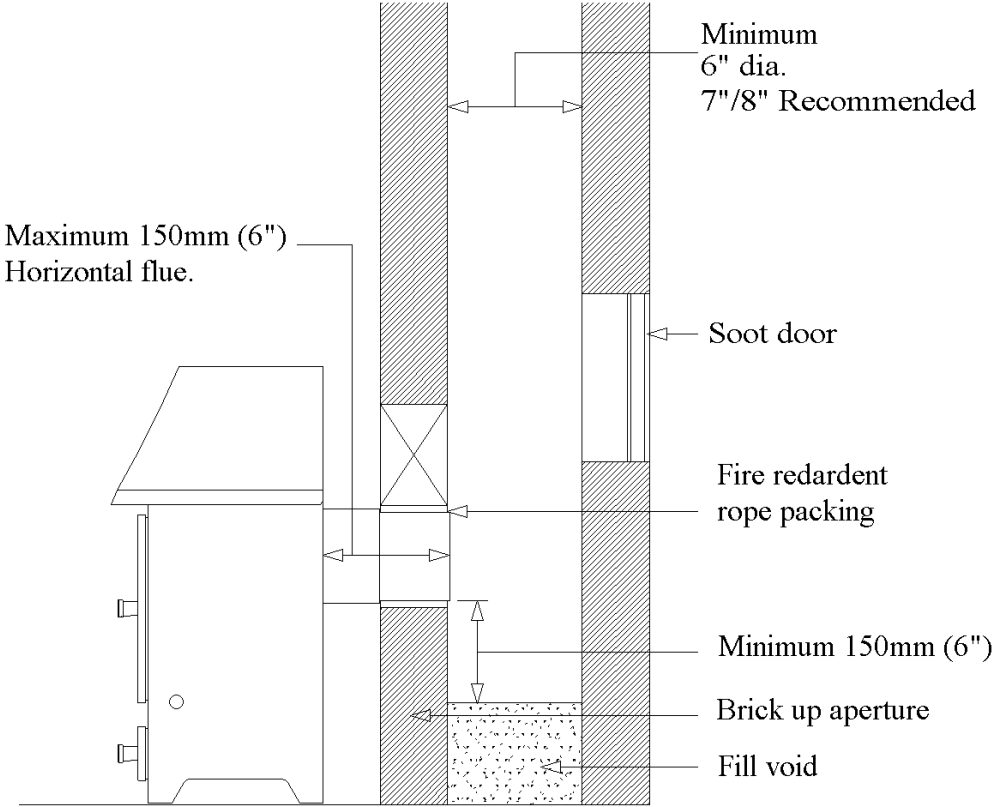

REAR FLUE OUTLET

## TYPICAL METAL INSULATED CHIMNEY SYSTEM

TO BE INSTALLED TO THE CHIMNEY MANUFACTURERS INSTRUCTIONS IN COMPLIANCE WITH BUILDING REGULATIONS AND BS7566 Pts 1-4

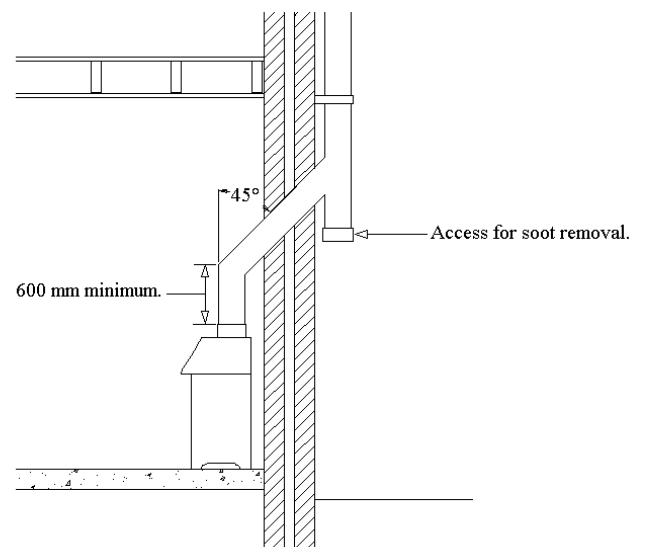
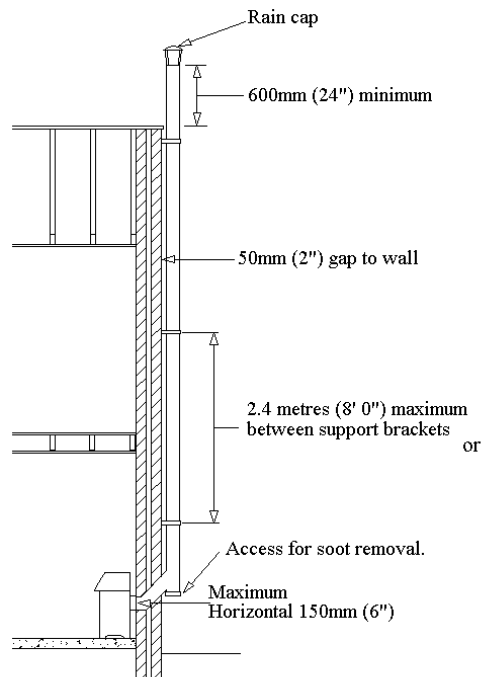

### PLAN VIEW OF REGISTER PLATE AND CLEARANCES FOR NON INSULATED FLUES

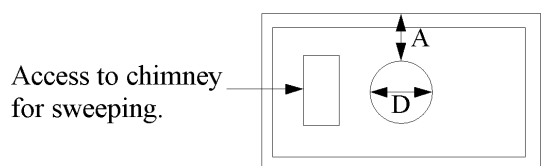

A is minimum clearance for non-insulated flue =

1.5 x D to a non-combustible surface/material  
or  
3 x D to combustible surface/material

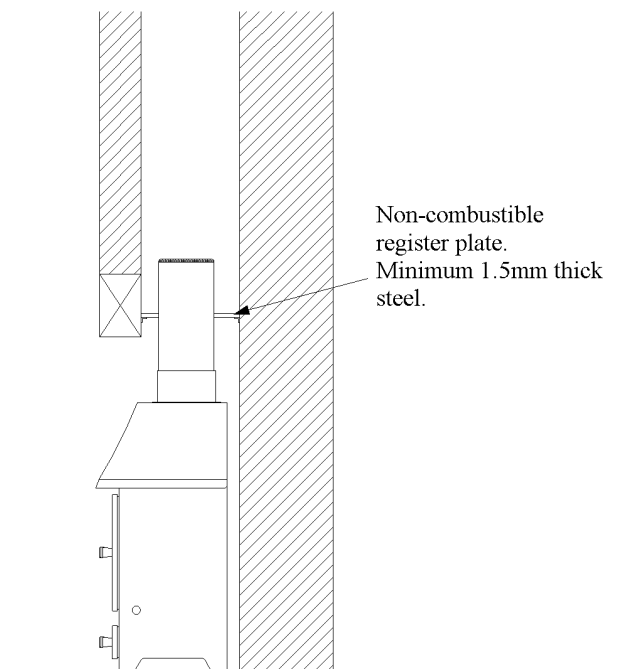

### TOP FLUE OUTLET



## INSTALLATION

---

### ADD IN BOILERS

Arley wood and multifuel stoves offer the option of a cantilever boiler or a slab boiler, which occupies the position of the rear firebox liner panels.

#### Fitting:

- Remove the fuel retainers, rear firebox liner panels and throat plate.
- Knock out the blanking discs in the back plate corresponding to the terminals on the boiler.
- Introduce the boiler to the appliance through the main fire door and locate the terminal pipes through the back plate holes and seal around boiler terminals with fire cement.
- Engage locking nuts to the thread of the terminals and tighten to secure the boiler in position, ready for connection to flow and return pipes.
- Replace throat plate (slab boilers only) and fuel retainers.

*Do not fit a throat plate with a cantilever boiler.*

*Note: On boilers the terminal which is approximately flush with the edge of the boiler must be fitted uppermost, to prevent "Kettling".*

### WATER CONNECTIONS

#### Heating systems

The size of the heating system which can be run, will depend on the output rating of the appliance. It will be necessary to work out heat loss calculations for the system proposed in order to establish the kW/hr rating. An appliance that will meet this figure can then be chosen; (for boiler outputs please refer to the brochure).

The constructional requirements of installing and connecting the appliance also need to be taken into account when selecting. Design and calculations

for individual heating systems should be carried out by a qualified heating engineer. In many cases your supplier will be able to offer advice and assistance.

#### Direct Systems

Stainless steel boilers, either factory fitted or retro-fitted as add-in boilers enable connection to direct systems to be made without the need to change the cylinder or to fit an expansion tank. This applies to domestic water supply only **and should not be done when in an area with soft water.** If radiators are used then an indirect system must be utilised.

To connect the cylinder use 28mm copper pipes. Ensure that the pipes rise continuously to the cylinder.

Ensure that the runs are not too long, i.e. 20ft maximum each for flow and return. Install the cylinder above the level of the fire, and as close to it as possible. (the higher the cylinder the faster the circulation). Ensure that no valves are present in the circulating pipes.

#### Indirect Systems- The Domestic Hot Water Circuit

In addition to providing hot water the primary circuit is essential in providing a "heat leak" to absorb excessive heat produced in the event of the circulation pump shutting down.

Heat is produced in varying quantities while the fire is alight and care must be taken to ensure that effective circulation can occur around the primary circuit to carry heat away and thus stop boiling. The output of any radiator installed as a "heat leak" should not be less than 10% of the rated output of the appliance. The radiator should **not** be fitted with a control valve.

The cylinder must be of the indirect type with a minimum capacity of 110 litres, conforming to BS 1566 part 1.



Primary flow and return pipes should be 28mm diameter. The cylinder should be installed at a higher level than the appliance, and as close to it as possible (the higher the cylinder the faster the circulation). The flow and return pipes should not be longer than 20ft each. Pipe runs should rise continually from the boiler to the cylinder.

A radiator of approximately 25 sq.ft. should be connected into the primary circuit, if installed in the bathroom it provides a means of drying towels in the summer.

### Safety Vent Circuit

This circuit consists of a cold feed pipe, expansion pipe, and expansion tank. The possibility that water may boil can never be completely ruled out, and it is therefore vital to ensure that cold water can be supplied to the boiler and steam vented from it at all times.

The expansion tank should have a capacity of at least 7 % of the system's water capacity. The cold water feed pipe should be at least 22mm diameter.

There must not be any shut off valves in the circuit. Pipes should be run to avoid air locks. A spring safety valve should be fitted to the expansion pipe close to the boiler.

It is often possible, and is good practice, to utilise the primary flow and return as part of the safety circuit. The ball valve should have a copper ball. The overflow pipe from the expansion tank should be 28mm diameter copper. Pipes in unheated spaces must be lagged.

### FINAL CHECK

Before handing over the installation to the customer it is strongly recommended that the appliance is lit and the functioning of the chimney, hot water and heating system is checked.

A checklist (Pre-lighting Checks) appears in the Operating Instructions, but in addition to this the installer should:

- **Operate the heating system and set the pump head.**
- **Balance the radiators.**
- **Re-vent and ensure no air locks.**
- **Check the circulation round the primary system and the heat leak radiator, particularly when the pump is running, to ensure circulation is not reversed.**
- **Be sure that the chimney is operating and that ALL smoke and fumes are vented to the atmosphere through the chimney terminal.**
- **Check all joints and seals.**
- **Clean the outside of the appliance to prevent any stains becoming burnt on.**
- **Check the flue draught which should read 1 - 2mm, or 0.1 - 0.2mbar.**

The following details **must** be checked and completed in full by the installer at the time of installation. Please answer all questions as fully as possible. **Arada Ltd** can not be held responsible for chimney or installation.

<b>HOT WATER SYSTEMS</b>	
Is the boiler cross-flowed?	YES / NO
Are the pipes correctly sized?	YES / NO
What is the calculated output required to heat the system?	
Is a heat leak fitted?	YES / NO
What is the return water temperature?	
Is the pump thermostatically controlled by a pipe stat?	YES / NO
What is the height and distance of the hot water tank above the stove?	

# INSTALLATION







## CHECKLIST

### Hearths, Fireplaces, Flues and chimneys





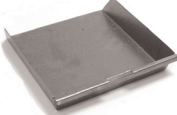

This checklist is to ensure hearths, fireplaces, flues and chimneys are satisfactory, and to show what you have done to comply with the requirements of The Building Regulations 2000 Approved Document J 2002.

1. Building address, where work has been carried out..... .....	
2. Identification of hearth, fireplace chimney or flue	
3. Firing capability: solid fuel/gas/.	
4. Intended type of appliance. State model and output.	
5. Ventilation provisions for the appliance: State type and area of permanently open vents.	
6. Chimney or flue construction a) State the type or make and whether new or existing. b) internal flue size (and equivalent height, where calculated - natural draught gas appliances only). c) If clay or concrete flue liners used confirm that they are correctly jointed with socket end uppermost and state jointing materials used. d) If an existing chimney has been refurbished with a new liner, type or make of liner fitted. e) Details of flue outlet terminal and diagram reference. Outlet Details:  Complies with:  f) Number and angle of bends. g) Provision for cleaning and recommended frequency.	
7. Hearth. Form of construction. New or existing?	
8. Inspection and testing after completion Tests carried out by: Tests and results Flue inspection visual sweeping coring ball smoke Appliance (where included) spillage	
I/we the undersigned confirm that the above details are correct. In my opinion, these works comply with the relevant requirements in Part J of Schedule 1 to the Building regulations.	
Print name and title.....Profession.....	
Capacity.....Telephone.....	
Address.....Post code.....	
Signed.....Date.....	
Registered membership of..(e.g. CORGI, OFTEC, HETAS, NACE, NACS).....	

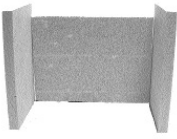
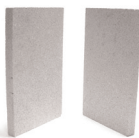







## PARTS LIST

Part Description	Visual Aid (not to scale)	Arley 5 Wood	Arley 5 Multifuel	Arley 7 Wood	Arley 7 Multifuel	Arley 11 Wood	Arley 11 Multifuel
1. Fuel Retainers		AFS1150	AFS1150	AFS1012	AFS1012	AFS1161	AFS1161
2. Throat Plate		AFS1018	AFS1018	AFS1019	AFS1019	AFS1020	AFS1020
3. Grate Bar Set		N/A	AFS001	N/A	AFS001	N/A	AFS001
4. Hot Plate		AFGS064	AFGS064	AFS009	AFS009	AFS009	AFS009
5. Operating Tool		AFS008	AFS008	AFS008	AFS008	AFS008	AFS008
6. Ashpan		AFS058	AFS058	AFS058	AFS058	AFS050	AFS050
7. Flue Spigot		AFS009A	AFS009A	AFS010	AFS010	AFS010	AFS010

## PARTS LIST

Part Description	Visual Aid (not to scale)	Arley 5 Wood	Arley 5 Multifuel	Arley 7 Wood	Arley 7 Multifuel	Arley 11 Wood	Arley 11 Multifuel
<b>8. Liner Set</b>		AFS1015	AFS1015	AFS1156	AFS1156	AFS1163	AFS1163
<b>9. Side Liner</b>		AFS1058	AFS1058	AFS1058	AFS1058	AFS1164	AFS1164
<b>10. Back Liner Set</b>		AFS1059	AFS1059	AFS1157	AFS1157	AFS1165	AFS1165
<b>11. Glass Replacement Kit Complete with Gasket</b>		AFS1075	AFS1075	AFS1009	AFS1009	AFS1095	AFS1095
<b>12. Glass Clips</b>		AFS1010	AFS1010	AFS1010	AFS1010	AFS1010	AFS1010
<b>13. Hinge kit Comprises 2 Hinges &amp; 4 Fixings Per Set.</b>		AFS047	AFS047	AFS047	AFS047	AFS047	AFS047
<b>14. Airwash (Curved)</b>		AFS1144	AFS1144	AFS1144	AFS1144	AFS1144	AFS1144
<b>15. Feet &amp; Fixings</b>		AFS1153	AFS1153	AFS1153	AFS1153	AFS1168	AFS1168

## PARTS LIST

Part Description	Visual Aid (not to scale)	Arley 5 Wood	Arley 5 Multifuel	Arley 7 Wood	Arley 7 Multifuel	Arley 11 Wood	Arley 11 Multifuel
<b>16.</b> Fire Door Rope Kit Complete with Door Rope Glue.		AFS1021	AFS1021	AFS1021	AFS1021	AFS1021	AFS1021
<b>17.</b> Main Door Assembly Complete with Handle, Glass, Gaskets, Clips and Seal.		AFS1145	AFS1145	Left Hand AFS1158 Right Hand AFS1159	L/H AFS1158 R/H AFS1159	L/H AFS1166 R/H AFS1167	L/H AFS1166 R/H AFS1167
<b>18.</b> Comb with Comb Extension		N/A	AFS1149	N/A	AFS1154	N/A	AFS1169
<b>19.</b> Fire Door Locking Assembly		AFS1146	AFS1146	AFS1146	AFS1146	AFS1146	AFS1146
<b>20.</b> Rear Grate Bar Support		N/A	AFS1152	N/A	AFS1155	N/A	AFS1170
<b>21.</b> Arrow Fires Gauntlet Gloves		AFS997	AFS997	AFS997	AFS997	AFS997	AFS997
<b>22.</b> Wood Burning Tray		AFS1151	ARL5 WBTRAY	AFS1160	ARL7 WBTRAY	AFS1162	ARL11 WBTRAY
<b>23.</b> Multifuel Upgrade Kit		ARL5M GRATE	N/A	ARL7M GRATE	N/A	ARL11M GRATE	N/A

## GUARANTEE

---

### *Guarantee*

Once again we would like to thank you for buying an Aarrow fire.

When you buy an **Aarrow Fire**, you are not only buying a first class appliance - you are buying a commitment from us to look after you and your appliance for as long as you want.

Your Aarrow Fire carries a guarantee against defects of manufacture and faulty workmanship for a period of three years from the date of purchase. This does not apply to items which would be subject to fair wear or tear. Firebox liner panels, fuel retainers, throat plate, door rope, door glass and gaskets are not covered by the guarantee. However, should you have any problems with your appliance please contact your Aarrow stockist who will have the knowledge and facilities to help you.

Arada Ltd will not be responsible for any consequential or incidental loss, damage, or injury however caused.

**Claims are not valid where the installation does not conform to local Building Regulations and fire codes.**

The Guarantee is conditional upon the appliance being serviced and checked annually by a qualified heating engineer.

The Manufacturers decision shall be final.

**If your appliance proves to be defective as a result of faulty materials or workmanship during guarantee, we will repair or replace it FREE OF CHARGE as long as the fire has been installed according to the manuals instructions.**

**USE OF SPARE PARTS OTHER THAN THOSE SUPPLIED BY ARADA LTD WILL INVALIDATE THE APPLIANCE WARRANTY.**

All Guarantee periods commence on the date of purchase and are non-transferable.

Our Guarantee is offered as an addition to your statutory rights.

If you think your fire is not working correctly or in the case of a breakdown, **please call your local Aarrow Fires retailer**, who will have the knowledge and experience to assist you.

When you contact them they will need to know :

1. Your name, address, post code and telephone number.
2. Stove serial number
3. Clear and concise details of the fault.

---

### **CUSTOMER REGISTRATION**

See card enclosed

**To guarantee the very best in after-sales service, do not forget to complete and return your Customer Registration Card within 14 days (a stamp is required).**

Just complete the form and return it to us to benefit from our *three year Guarantee*.

**Please contact us direct 01308 427234 if no Customer Registration Card is included.**



## FINAL FACTORY CHECK LIST

Model.....
Serial No.....

QUALITY	
FINISH	
PARTS	
FLUE OUTLET	
HOT PLATE	
FUEL RETAINERS	
GRATE BARS / WOOD TRAY	
FIREBOX LININGS	
THROAT PLATE	
AIR WASH	
DOOR CATCHES	
FEET & FIXINGS	
ASH PAN	
OPERATING TOOL	
OPERATING INSTRUCTIONS	

*I've checked it  
and it's O.K.*

Assembled by.....

Checked by .....

Please ensure the enclosed registration card is completed and returned to Arada Ltd and the following information completed for your own information.

Date of Purchase.....

Name and address of supplier.....

.....  
.....

*\* Please ensure installer completes INSTALLATION CHECK LIST details on page 26 of this manual.*

*If an add in boiler is fitted please also ensure information on page 25 is completed.*