

PREMIER VITREOUS ENAMEL FLUE PIPE PRICE LIST



Premier Vitreous Flue Pipe and Accessories

Manufacturers of Vitreous Enamelled Flue Pipe over 40 years; as established market leaders we offer the widest range of products available in the market today.

Premier Flue is dedicated to giving the best quality, delivery, and service throughout the UK and Ireland.





Premier Flue Limited is certified for ISO 9001 and our products are CE marked by TUV giving confidence in quality and care.











Accreditations











Product range manufactured in accordance with ISO 9001:2015







The Vitreous Enamel coating meets the recommended requirement for high resistance to heat - BS 1344 Part 1:1994 Part 7: 1984 and acid resistance BSEN 28706-1:2011







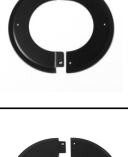

Manufactured in the UK

Description	Order Code	Diameter	Length/Dimension			Price	
			A	B	C		
6" Pipes 	VP6050	125mm (5")	150mm (6")			£56.61	
	VP6060	150mm (6")	150mm (6")			£67.42	
Standard Pipe No Door  <p>Fixed straight lengths are available in four nominal metric sizes.</p>	VNDP140	100mm(4")	300mm (1ft)			£50.02	
	VNDP150	125mm (5")	300mm (1ft)			£59.88	
	VNDP160	150mm (6")	300mm (1ft)			£70.65	
	VNDP170	175mm (7")	300mm (1ft)			£81.37	
	VNDP180	200mm (8")	300mm (1ft)			£94.64	
	VNDP240	100mm(4")	600mm (2ft)			£73.22	
	VNDP250	125mm (5")	600mm (2ft)			£74.22	
	VNDP260	150mm (6")	600mm (2ft)			£84.31	
	VNDP270	175mm (7")	600mm (2ft)			£98.61	
	VNDP280	200mm (8")	600mm (2ft)			£112.35	
	VNDP340	100mm(4")	900mm (3ft)			£98.38	
	VNDP350	125mm (5")	900mm (3ft)			£101.81	
	VNDP360	150mm (6")	900mm (3ft)			£112.66	
	VNDP370	175mm (7")	900mm (3ft)			£128.71	
	VNDP380	200mm (8")	900mm (3ft)			£156.30	
	Standard Pipe With Door  <p>Fixed straight lengths are available in four nominal metric sizes. Enamel door for cleaning and inspection purposes.</p>	VWDP140	100mm(4")	300mm (1ft)	102	102	£73.20
VWDP150		125mm (5")	300mm (1ft)	82	135	£81.37	
VWDP160		150mm (6")	300mm (1ft)	86	135	£91.87	
VWDP170		175mm (7")	300mm (1ft)	80	135	£102.82	
VWDP180		200mm (8")	300mm (1ft)	86	135	£116.03	
VWDP240		100mm(4")	600mm (2ft)	50	102	£102.84	
VWDP250		125mm (5")	600mm (2ft)	127	202	£103.83	
VWDP260		150mm (6")	600mm (2ft)	124	202	£114.92	
VWDP270		175mm (7")	600mm (2ft)	124	202	£126.94	
VWDP280		200mm (8")	600mm (2ft)	124	202	£141.26	
VWDP340		100mm(4")	900mm (3ft)	50	102	£126.94	
VWDP350		125mm (5")	900mm (3ft)	124	202	£130.53	
VWDP360		150mm (6")	900mm (3ft)	124	202	£141.26	
VWDP370		175mm (7")	900mm (3ft)	127	202	£171.03	
VWDP380		200mm (8")	900mm (3ft)	130	202	£184.36	
Appliance Connector No Door  <p>Double socket to facilitate larger outlet rings on appliance</p>		VAPPC150	125mm (5")	300mm (1ft)			£59.88
	VAPPC160	150mm (6")	300mm (1ft)			£70.65	
	VAPPC250	125mm (5")	600mm (2ft)			£74.20	
	VAPPC260	150mm (6")	600mm (2ft)			£84.31	
	VAPPC350	125mm (5")	900mm (3ft)			£101.81	
	VAPPC360	150mm (6")	900mm (3ft)			£112.66	
	VAPPC450	125mm (5")	1200mm(4ft)			£131.58	
	VAPPC460	150mm (6")	1200mm(4ft)			£148.43	
	Appliance Connector With Door  <p>Double socket to facilitate larger outlet rings on appliance</p>	VAPPCD150	125mm (5")	300mm (1ft)	82	135	£81.17
		VAPPCD160	150mm (6")	300mm (1ft)	86	135	£91.87
VAPPCD250		125mm (5")	600mm (2ft)	127	202	£103.83	
VAPPCD260		150mm (6")	600mm (2ft)	124	202	£114.92	
VAPPCD350		125mm (5")	900mm (3ft)	124	202	£130.53	
VAPPCD360		150mm (6")	900mm (3ft)	124	202	£141.26	
VAPPCD450		125mm (5")	1200mm(4ft)	124	202	£163.79	
VAPPCD460		150mm (6")	1200mm(4ft)	130	202	£177.85	

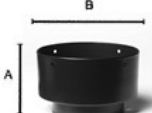
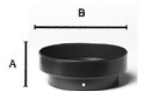
Description	Order Code	Diameter	Length/Dimension			
			A	B	C	
Adjustable Pipes No Door Adjustable pipes are used to achieve specific flue lengths. If fitted close to the appliance this will enable the appliance to be removed without having to dismantle the flue. 	VADJ40	100mm (4")	350-550	350		£98.72
	VADJ50	125mm (5")	350-550	350		£115.74
	VADJ60	150mm (6")	350-550	350		£132.79
	VADJ70	175mm (7")	350-550	350		£153.17
	VADJ80	200mm(8")	350-550	350		£173.61
	VADJE50	125mm (5")	600-1020	600		£130.58
	VADJE60	150mm (6")	600-1020	600		£147.85
	VADJNDE50	125mm (5")	900-1600	900		£219.39
	VADJNDE60	150mm (6")	900-1600	900		£246.50
	Adjustable Pipes With Door MK2 Door on all diameters Extended length MK2 Door on all diameters Enamel door for cleaning and inspection purposes. 	VADJWD40	100mm (4")	600-900	600	
VADJWD50		125mm (5")	600-900	600		£145.84
VADJWD60		150mm (6")	600-900	600		£162.23
VADJWD70		175mm (7")	600-900	600		£182.67
VADJWD80		200mm (8")	600-900	600		£203.05
VADJWDE40		100mm (4")	900-1450	900		£219.12
VADJWDE50		125mm (5")	900-1450	900		£233.36
VADJWDE60		150mm (6")	900-1450	900		£262.61
VADJWDE70		175mm (7")	900-1450	900		£310.17
VADJWDE80		200mm (8")	900-1450	900		£341.89
90° Swept Elbow No Door Designed to angle the flue pipe run where necessary 	VNSE5090	125mm (5")	159	159		£116.32
	VNSE6090	150mm (6")	181	175		£127.12
110° Swept Elbow No Door Designed to angle the flue pipe run where necessary 	VNSE50110	125mm (5")	140	140		£94.64
	VNSE60110	150mm (6")	140	140		£109.09
135° Swept Elbow No Door Designed to angle the flue pipe run where necessary 	VNSE50135	125mm (5")	125	125		£94.64
	VNSE60135	150mm (6")	133	133		£109.09
90° Bend No Door Designed to angle the flue pipe run where necessary 	VNDB4090	100mm (4")	143	152		£105.47
	VNDB7090	175mm (7")	190	197		£148.43
	VNDB8090	200mm (8")	206	225		£174.25
110° Bend No Door Designed to angle the flue pipe run where necessary 	VNDB40110	100mm (4")	140	140		£84.06
	VNDB70110	175mm (7")	165	165		£128.71
	VNDB80110	200mm (8")	203	203		£156.42
135° Bend No Door Designed to angle the flue pipe run where necessary 	VNDB40135	100mm (4")	140	140		£84.06
	VNDB70135	175mm (7")	165	165		£128.71
	VNDB80135	200mm (8")	156	156		£156.42
150° Bend No Door Designed to angle the flue pipe run where necessary 	VNDB40150	100mm (4")	140	140		£84.06
	VNDB50150	125mm (5")	137	137		£94.64
	VNDB60150	150mm (6")	140	140		£109.09
	VNDB70150	175mm (7")	179	179		£128.71
	VNDB80150	200mm (8")	185	155		£156.42
165° Bend No Door Designed to angle the flue pipe run where necessary 	VNDB40165	100mm (4")	143	143		£84.06
	VNDB50165	125mm (5")	156	156		£94.64
	VNDB60165	150mm (6")	150	150		£109.09
	VNDB70165	175mm (7")	193	193		£128.71
	VNDB80165	200mm (8")	197	197		£156.42

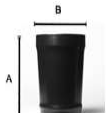
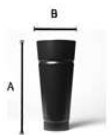
Description	Order Code	Diameter	Length/Dimension			
			A	B	C	
90° Swept Elbow With Door Designed to angle the flue pipe run where necessary Enamel door for cleaning and inspection purposes.		VWSE5090 125mm (5") VWSE6090 150mm (6")	159	159		£144.65
			181	175		£155.58
110° Swept Elbow With Door Designed to angle the flue pipe run where necessary Enamelled door for cleaning and inspection purposes.		VWSE50110 125mm (5") VWSE60110 150mm (6")	140	140		£126.94
			140	140		£137.72
135° Swept Elbow With Door Designed to angle the flue pipe run where necessary Enamel door for cleaning and inspection purposes.		VWSE50135 125mm (5") VWSE60135 150mm (6")	125	125		£126.94
			133	133		£137.72
90° Bend With Door Designed to angle the flue pipe run where necessary Enamel door for cleaning and inspection purposes.		VWDB4090 100mm (4") VWDB7090 175mm (7") VWDB8090 200mm (8")	143	152		£134.13
			190	197		£177.00
			206	225		£202.85
110° Bend With Door Designed to angle the flue pipe run where necessary Enamel door for cleaning and inspection purposes.		VWDB40110 100mm (4") VWDB70110 175mm (7") VWDB80110 200mm (8")	140	140		£114.35
			165	165		£155.58
			203	203		£184.11
135° Bend With Door Designed to angle the flue pipe run where necessary Enamel door for cleaning and inspection purposes.		VWDB40135 100mm (4") VWDB70135 175mm (7") VWDB80135 200mm (8")	140	140		£114.35
			165	165		£155.58
			156	156		£184.11
150° Bend With Door Designed to angle the flue pipe run where necessary Enamel door for cleaning and inspection purposes.		VWDB40150 100mm (4") VWDB50150 125mm (5") VWDB60150 150mm (6") VWDB70150 175mm (7") VWDB80150 200mm (8")	140	140		£114.35
			137	137		£126.94
			140	140		£137.72
			179	179		£155.58
			185	155		£184.11
165° Bend With Door Designed to angle the flue pipe run where necessary Enamel door for cleaning and inspection purposes.		VWDB40165 100mm (4") VWDB50165 125mm (5") VWDB60165 150mm (6") VWDB70165 175mm (7") VWDB80165 200mm (8")	143	143		£114.35
			156	156		£126.94
			150	150		£137.73
			193	193		£155.58
			197	197		£184.12
Long Tail Bend with Door connects appliance to chimney reducing number of joints		VLTBWD40 100mm (4") VLTBWD50 125mm (5") VLTBWD60 150mm (6") VLTBWD70 175mm (7") VLTBWD80 200mm (8")	140	600		£187.56
			125	600		£201.14
			133	600		£222.04
			165	600		£254.19
			170	600		£296.47
1 Piece Stove Offset connects the appliance to the chimney without joints		VOFFS40 100mm (4") VOFFS50 125mm (5") VOFFS60 150mm (6") VOFFS70 175mm (7")	558	100		£168.19
			565	100		£189.27
			558	100		£218.19
			DOR	DOR		£239.29
NEW 1 Piece Stove Offset with Door connects the appliance to the chimney without joints		VOFFSWD50 125mm (5") VOFFSWD60 150mm (6")	565	100		£221.58
			567	100		£246.79

Description	Order Code	Diameter	Length/Dimension			
			A	B	C	
NEW Stove Offset With Adjustable Height connects the appliance to the chimney without joints Adjustable pipe length allows the stove to be position and the fluepipe connected Also facilitates sweeping the flue without disturbing the flue system. 	VAOFFS50	125mm (5")	440-540	100		£253.33
	VAOFFS60	150mm (6")	440-540	100		£290.73
Standard Tee with Branch Spigot Used at the rear of an appliance with horizontal outlet and to be used in conjunction with separate stainless steel tee cap that clips on and off for cleaning and inspection purposes 	VSTD40	100mm (4")	302		118	£130.53
	VSTD50	125mm (5")	302		140	£138.59
	VSTD60	150mm (6")	302		152	£146.54
	VSTD70	175mm (7")	302		162	£156.42
	VSTD80	200mm (8")	302		185	£237.75
Standard Tee with Branch Socket (stabilising tee) can accept stabilising unit 	VSTB40	100mm (4")	302		121	£130.53
	VSTB50	125mm (5")	302		140	£138.59
	VSTB60	150mm (6")	302		152	£146.54
	VSTB70	175mm (7")	302		162	£156.42
	VSTB80	200mm (8")	302		185	£237.75
Angled Tee with Branch Spigot 135 Degree 	VAGT40	100mm (4")	305	226	216	£132.24
	VAGT50	125mm (5")	305	226	226	£146.54
	VAGT60	150mm (6")	305	235	260	£156.42
	VAGT70	175mm (7")	405	280	275	£237.75
	VAGT80	200mm (8")	405	290	330	£263.66
NEW Swept Elbow with Debris Trap Used at the rear of an appliance with horizontal outlet to be used in conjunction with separate stainless steel tee cap that clips on and off for cleaning and inspection purposes 	VDTSE5090	125mm (5")	159	159		£192.18
	VDTSE6090	150mm (6")	181	175		£203.67
Tee-Caps Stainless Steel clips on spigot can be easily for removed for flue sweeping 	VTC40SS	100mm (4")				£51.87
	VTC50SS	125mm (5")				£53.60
	VTC60SS	150mm (6")				£57.15
	VTC70SS	175mm (7")				£60.75
	VTC80SS	200mm (8")				£67.96
Aluminium Rain Cap 	VARC40	100mm (4")				£34.88
	VARC50	125mm (5")				£38.46
	VARC60	150mm (6")				£41.99
	VARC70	175mm(7")				£67.07
	VARC80	200mm (8")				£71.49
Standard Trim Rings Designed to fit around the pipe as it enters the ceiling or wall 	VCTR40	100mm (4")				£34.06
	VCTR50	125mm (5")				£34.06
	VCTR60	150mm (6")				£34.06
	VCTR70	175mm(7")				£42.92
	VCTR80	200mm (8")				£42.92
Split Trim Rings Designed to fit around the pipe as it enters the ceiling or wall can be retro fitted 	VCTRS40	100mm (4")				£64.12
	VCTRS50	125mm (5")				£66.29
	VCTRS60	150mm (6")				£69.54
	VCTRS70	175mm(7")				£76.94
	VCTRS80	200mm (8")				£80.18
Angled Trim Rings 45° Designed to fit around the pipe as it enters the ceiling or wall 	VCTR40135	100mm (4")				£73.90
	VCTR50135	125mm (5")				£74.10
	VCTR60135	150mm (6")				£84.00
	VCTR70135	175mm(7")				£88.38
	VCTR80135	200mm (8")				£93.31

Description	Order Code	Diameter	Length/Dimension	
Split Trim Rings Flush With Wall Designed to fit around the pipe as it enters the ceiling or wall specifically where the flue pipe is close to the wall ie Range cookers or stoves. The advantage being it can be retro fitted 	VCTRFW40	100mm (4")		£66.17
	VCTRFW50	125mm (5")		£66.29
	VCTRFW60	150mm (6")		£69.54
	VCTRFW70	175mm (7")		£76.94
	VCTRFW80	200mm (8")		£80.18
Flue Liner Adaptor ** Spigot fits into vit Socket & allows same dia of flue liner into socket** 	VFLA40	100mm (4")	100 (4") 115 (4 9/16)	£57.85
	VFLA50	125mm (5")	100 (4") 142 (5 5/8)	£62.97
	VFLA60	150mm (6")	100 (4") 170 (6 3/8)	£66.36
	VFLA70	175mm(7")	100 (4") 187 (7 1/2)	£78.29
	VFLA80	200mm (8")	100 (4") 217 (8 1/2)	£81.66
Increasing Flue Liner ** Used to connect to next diameter of Flexible Flue Liner 	VIFA4X5	100x125mm (4x5")	100mm 140 (5 1/2)	£67.65
	VIFA5X6	125x150mm (5x6")	100mm 162 (6 1/2)	£72.79
Spun Increasing Adaptors **Used to connect next dia of vit into Socket** 	VIA40	100mm (4")	65 (2 1/2) 130 (5 1/16)	£55.39
	VIA50	125mm (5")	65 (2 1/2) 156 (6 3/16)	£56.33
	VIA60	150mm (6")	65 (2 1/2) 181 (7 1/8)	£59.91
	VIA70	175mm(7")	65 (2 1/2) 205 (8 1/16)	£76.57
Cut Length Adaptor ** Replaces socket on cut end of vit 	VCLA40	100mm (4")	56 (2 3/16) 105 (4 1/8)	£57.79
	VCLA50	125mm (5")	56 (2 3/16) 132 (5 1/4)	£60.75
	VCLA60	150mm (6")	65 (2 3/8) 154 (6 1/16)	£66.21
	VCLA70	175mm (7")	65 (2 3/8) 181 (7 1/8)	£67.96
	VCLA80	200mm (8")	65 (2 3/8) 210 (8 3/8)	£69.83
NEW Continental Stove Adaptor **Used to connect next dia of vit into Socket** 	VCSA05	125mm (5")	129mm Int. dia. Ext. 116mm	£62.97
	VCSA06	150mm (6")	155mm Int. dia. Ext. 135mm	£66.36
Straight Length Adaptors ** Goes up from Vit Spigot to next dia of Vit Socket** 	VCIA40	100mm (4")	257 (10") 130 (5 1/8)	£69.83
	VCIA50	125mm (5")	257 (10") 158 (6 1/4)	£69.83
	VCIA60	150mm (6")	257 (10") 180 (7 1/8)	£80.53
	VCIA70	175mm (7")	257 (10") 205 (8 1/8)	£95.63
Conical Increasing Adaptors Increases the dia of the vit socket by 2 	VCIA4X5	100 x 125mm	305 (12") 155 (61/8)	£69.83
	VCIA5X6	125 x 150mm	305 (12") 160 6 3/8)	£80.53
	VCIA6X7	150 x 175mm	305 (12") 198 (73/4)	£95.63
	VCIA7X8	175 x 200mm	305 (12") 223 (83/4)	£109.11
Double Socket Adaptor 	VDSA40	100mm (4")	85 (3 1/4") 105 (4 1/8)	£57.15
	VDSA50	125mm (5")	85 (3 1/4") 132 (5 1/4)	£60.75
	VDSA60	150mm (6")	85 (3 1/4") 154 (6 1/16)	£66.21
	VDSA70	175mm (7")	85 (3 1/4") 181 (7 1/8)	£67.96
	VDSA80	200mm (8")	85 (3 1/4") 210 (8 3/8)	£69.83
Double Spigot Adaptor 	VDPA40	100mm (4")	85 (3 1/4")	£57.15
	VDPA50	125mm (5")	85 (3 1/4")	£60.75
	VDPA60	150mm (6")	85 (3 1/4")	£66.21
	VDPA70	175mm (7")	85 (3 1/4")	£67.96
	VDPA80	200mm (8")	85 (3 1/4")	£69.83
Damper Unit Available in Gloss and Matt 	VDUA40	100mm (4")	115	£99.86
	VDUA50	125mm (5")	115	£105.76
	VDUA60	150mm (6")	115	£116.44
	VDUA70	175mm (7")	115	£142.92
Soot Doors Available in S/Steel or Brass 	VMK2D	5" & 6" Bends (Exc. Swept Elbow) & 4" Pipes		£9.04
	VMK3D	7" & 8" Bends 5-8" 1ft Pipes		£10.72
	VMK4D	2ft, 3ft, 4ft Pipes - 5" - 8"		£12.57

Description	Order Code	Diameter	Length/Dimension	
Enamelled Doors Available to Buy separately 	VMK1D5	Swept Elbow 5"	90° 110° 135°	£21.30
	VMK1D6	Swept Elbow 6"	90° 110° 135°	£21.30
	VMK2D	5" & 6" Bends 150° & 165° & ALL 4" Pipes		£16.37
	VMK3D	7" & 8" Bends 90°, 110°, 135°, 150° & 165°. 1' Pipes - 5"-8"		£21.30
	VMK4D	2ft, 3ft, 4ft Pipes - 5" - 8" (Please specify dia. when ordering)		£26.17
Gaskets For use with access door 	VMK2G	FOR SIZES REFER TO ABOVE DOORS SWEPT ELBOW 5" ONLY 6" ONLY		£7.13
	VMK3G			£7.13
	VMK4G			£7.13
	VMK1G5			£7.13
	VMK1G6			£7.13
Maintenance Joint Clip 	VMJC40	100mm (4")		£34.06
	VMJC50	125mm (5")		£34.06
	VMJC60	150mm (6")		£34.06
	VMJC70	175mm (7")		£34.06
	VMJC80	200mm (8")		£34.06
Galvanised Wall Brackets Available in 50mm & 275mm adjustment 	VWB040	100mm (4")	50 mm or 275 mm	£24.92 £38.17
	VWB050	125mm (5")	50 mm or 275 mm	£25.41 £38.64
	VWB060	150mm (6")	50 mm or 275 mm	£28.28 £41.52
	VWB070	175mm (7")	50 mm or 275 mm	£28.28 £41.52
	VWB080	200mm (8")	50 mm or 275 mm	£28.28 £41.52
Vitreous Enamelled Wall Brackets Cut to requirements 	VWBE040	100mm (4")	280 (11")	£65.39
	VWBE050	125mm (5")	280 (11")	£65.39
	VWBE060	150mm (6")	280 (11")	£65.39
	VWBE070	175mm (7")	280 (11")	£68.74
	VWBE080	200mm (8")	280 (11")	£68.74
NEW Door Damper Unit 	VMK1DDU5	Swept Elbow 5"	90° 110° 135°	£106.81
	VMK1DDU6	Swept Elbow 6"	90° 110° 135°	£108.69
	VMK2DDU	4", 5" & 6" Bends 150° & 165° & ALL 4" Pipes		£105.06
	VMK3DDU	7" & 8" Bends 90°, 110°, 135°, 150° & 165°. 1' Pipes - 5"-8"		£106.81
	VMK4DDU	2ft, 3ft, 4ft Pipes - 5" - 8"(Please specify dia. when ordering)		£112.52
Firebrand Fire Cement Recommended Fire for the Premier range as the products have been tested for CE purposes with this cement 	VFBC	NATURAL		£13.43
	VFBCB	BLACK		£16.46
	1KG TUB			
Carbon Monoxide Alarm	CMA			£134.64
New Standard Trim Rings With Spring Designed to fit around the pipe as it enters the ceiling or wall - the spring holds the Trim Ring in place without the need for screws 	VCTRSP50	125mm (5")		£40.80
	VCTRSP60	150mm (6")		£43.99
NEW Soot Door with Flow Testing Adaptor Available in Stainless Steel 	MK2FTD4S	All 4" Pipes		£14.52
	MK3FTD5S	5-8" 1ft Pipes		£16.21
	MK4FTD6S	2ft, 3ft, 4ft Pipes - 5" - 8"		£18.06
NEW Condensate Trap Adaptor	VCTA5X6			£69.48

Please note when ordering, Colours must be stated. Colours available are:-

B = Gloss Black **M** = Matt Black
W = White **R** = Brown

Special Colours:-

L = Blue **G** = Green
ID = Dovre Ivory **IJ** = Jotul Ivory
GD = Dovre Forest Green **LD** = Dovre Midnight Blue

Special Colours - PIPES - Standard Price List + 50%

Special Colours - BENDS - Standard Price List + 40%

Please add Code to the end of your Order or state Colour required

Please add Code to the end of your Order or state Colour required

Non-standard Products available to Order

BENDS AND OFFSET BENDS - FOR FULL DETAILS - PLEASE REFER TO BACK PAGE

90° SWEPT ELBOW

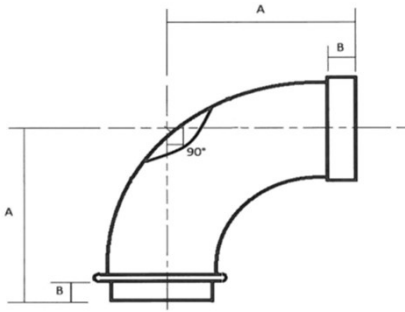

	5"	6"
A	135mm	170mm
B	32mm	32mm

110° SWEPT ELBOW

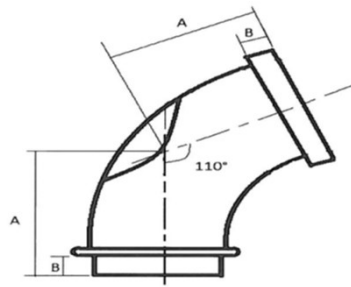

	5"	6"
A	135mm	170mm
B	32mm	32mm

135 SWEPT ELBOW

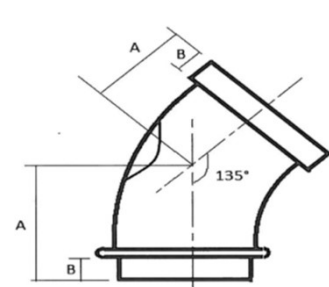

	5"	6"
A	135mm	170mm
B	32mm	32mm

150° BEND

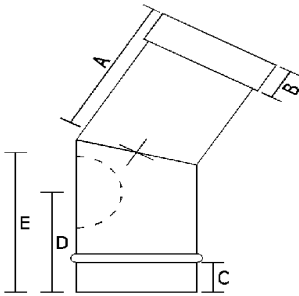

	4"	5"	6"	7"	8"
A	5 1/2"	5 3/8"	5 1/2"	7"	8"
	140mm	137mm	140mm	179mm	185mm
B	1 1/4"	1 1/4"	1 1/4"	1 1/4"	1 1/4"
	32mm	32mm	32mm	32mm	32mm
C	1 1/4"	1 1/4"	1 1/4"	1 1/4"	1 1/4"
	32mm	32mm	32mm	32mm	32mm
D	4"	4"	4"	4"	4"
	100mm	100mm	100mm	100mm	100mm
E	5 1/2"	5 3/8"	5 1/2"	7"	7 1/8"
	140mm	137mm	140mm	179mm	185mm

165° BEND

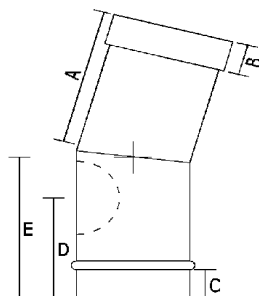

	4"	5"	6"	7"	8"
A	5 5/8"	6 1/4"	5 1/2"	7 7/8"	7 1/4"
	143mm	156mm	150mm	193mm	197mm
B	1 1/4"	1 3/8"	1 1/4"	1 1/4"	1 1/4"
	32mm	36mm	32mm	32mm	32mm
C	1 1/4"	1 1/4"	1 1/4"	1 1/4"	1 1/4"
	32mm	32mm	32mm	32mm	32mm
D	4"	4"	4"	4"	4"
	100mm	100mm	100mm	100mm	100mm
E	5 1/8"	6 1/4"	5 7/8"	7 5/8"	7 1/4"
	140mm	156mm	150mm	193mm	197mm

SWEPT OFFSETS

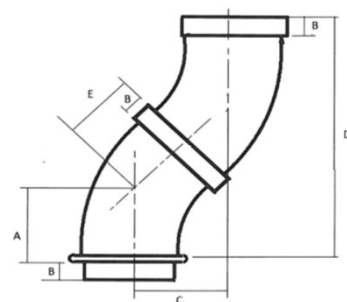

	135°	5"	6"
A	65mm	80mm	
B	32mm	32mm	
C	110mm	137mm	
D	285mm	330mm	
E	95mm	110mm	
	110°	5"	6"
A	105mm	110mm	
B	32mm	32mm	
C	153mm	270mm	
D	325mm	405mm	
E	135mm	170mm	
	90°	5"	6"
A	140mm	165mm	
B	32mm	32mm	
C	320mm	365mm	
D	320mm	365mm	
E	170mm	195mm	

135° OFFSET BEND

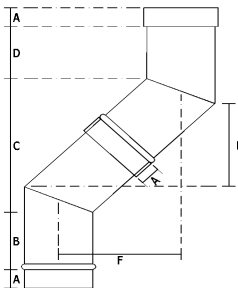

	4"	5"	6"	7"	8"
A	1 1/4"	1 3/8"	1 1/4"	1 1/4"	1 1/4"
	32mm	35mm	32mm	32mm	32mm
B	5 3/8"	3"	2 11/16"	3 3/4"	3 3/4"
	137mm	76mm	68mm	95mm	95mm
C	7 1/4"	8 1/2"	9 1/16"	12"	12"
	184mm	216mm	230mm	306mm	306mm
D	5 3/8"	3"	2 11/16"	3 3/4"	8 1/4"
	150mm	133mm	110mm	223mm	210mm
E	5 7/8"	5 3/4"	4 1/4"	5 3/4"	8 1/4"
	150mm	133mm	110mm	223mm	210mm
F	7 1/4"	7"	5 1/4"	8 5/8"	10"
	184mm	178mm	134mm	220mm	254mm

150° OFFSET BEND

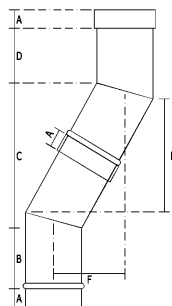

	4"	5"	6"	7"	8"
A	1 1/4"	1 3/8"	1 1/4"	1 1/4"	1 1/4"
	32mm	35mm	32mm	32mm	32mm
B	5 3/4"	3 1/2"	3 1/4"	5"	4 3/4"
	137mm	88mm	82mm	128mm	121mm
C	9 3/4"	9 1/2"	9 1/2"	13 3/4"	13 3/4"
	248mm	242mm	242mm	350mm	350mm
D	5 3/8"	3 1/2"	3 3/4"	5"	4 3/4"
	137mm	88mm	82mm	128mm	121mm
E	8"	9 1/4"	7 1/2"	13"	10"
	230mm	235mm	190mm	330mm	254mm
F	5 1/8"	5"	5 1/4"	7 1/2"	6 1/2"
	130mm	127mm	134mm	190mm	165mm

165° OFFSET BEND

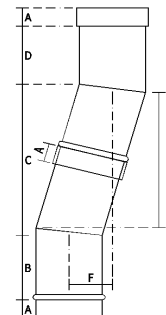

	4"	5"	6"	7"	8"
A	1 1/4"	1 3/8"	1 1/4"	1 1/4"	1 1/4"
	32mm	35mm	32mm	32mm	32mm
B	4"	4 1/2"	4 1/4"	6"	6 1/4"
	100mm	114mm	100mm	153mm	159mm
C	10 1/4"	11"	11 1/4"	15"	15"
	260mm	280mm	286mm	380mm	382mm
D	4"	4 1/2"	4 1/4"	6"	6 1/4"
	100mm	114mm	100mm	153mm	159mm
E	10"	10"	10 3/4"	13 3/4"	14 1/4"
	254mm	254mm	260mm	350mm	360mm
F	2 1/4"	2 3/4"	3 1/2"	7 1/8"	4"
	60mm	70mm	89mm	184mm	100mm