

**ERSATZTEILLISTE / PÓTALKATRÉSZ LISTA
FÜR KAMINÖFEN/ KANDALLÓKHOZ
TYP / TÍPUS: TYP 113 80 MYRO; TYP 113 81 MYRA**

Bs/Nr:	Artikel Nr:	Artikel Typ:	
A	W20001138010	TYP 11380 MYRO S StNS HNS 8KW	WAMSLER
B	W20001138110	TYP 11381 MYRA S APNS RUND HNS 8KW	WAMSLER

MYRA MYRO
2015.10.06.

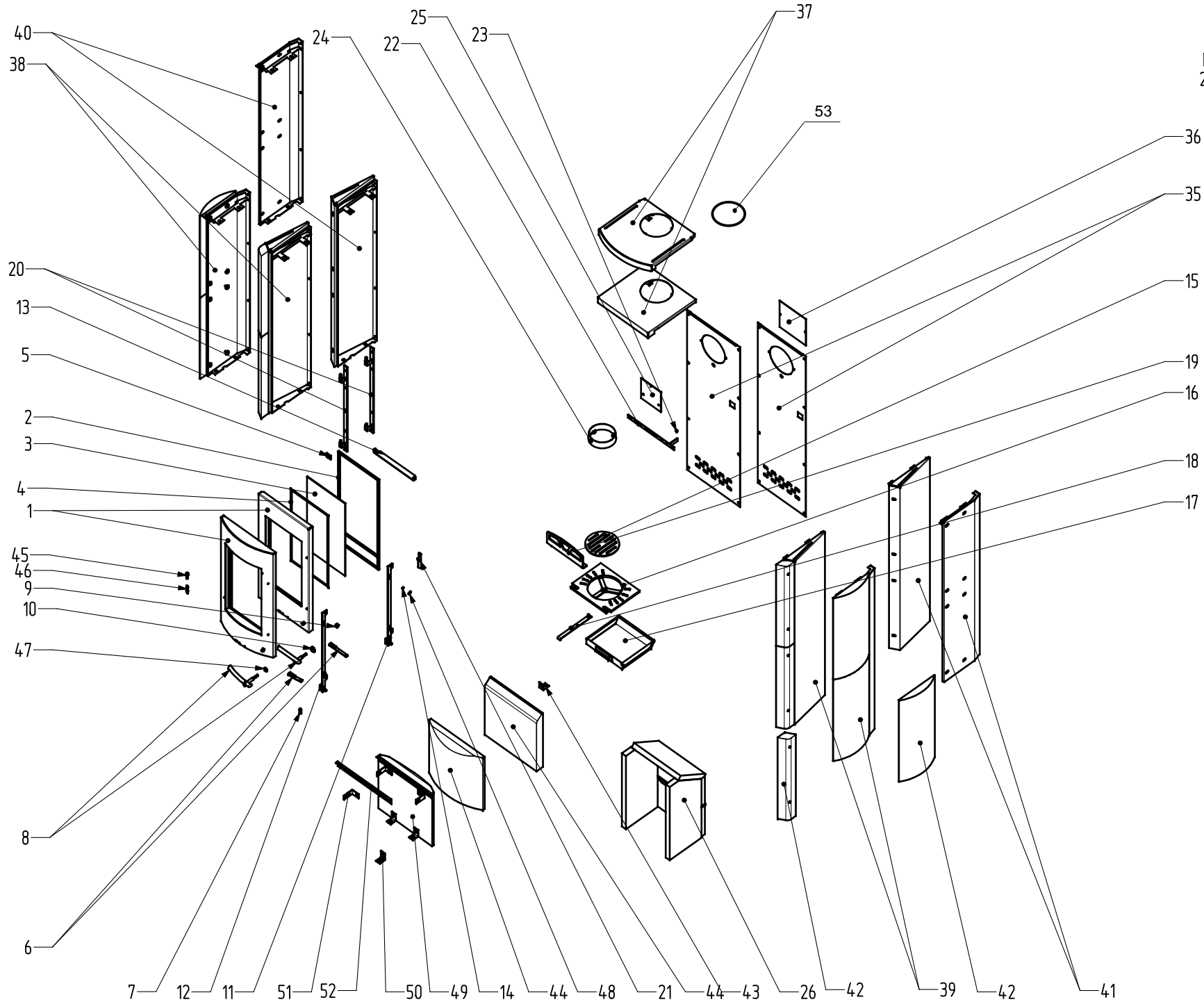

MYRA MYRO
2015.10.06.

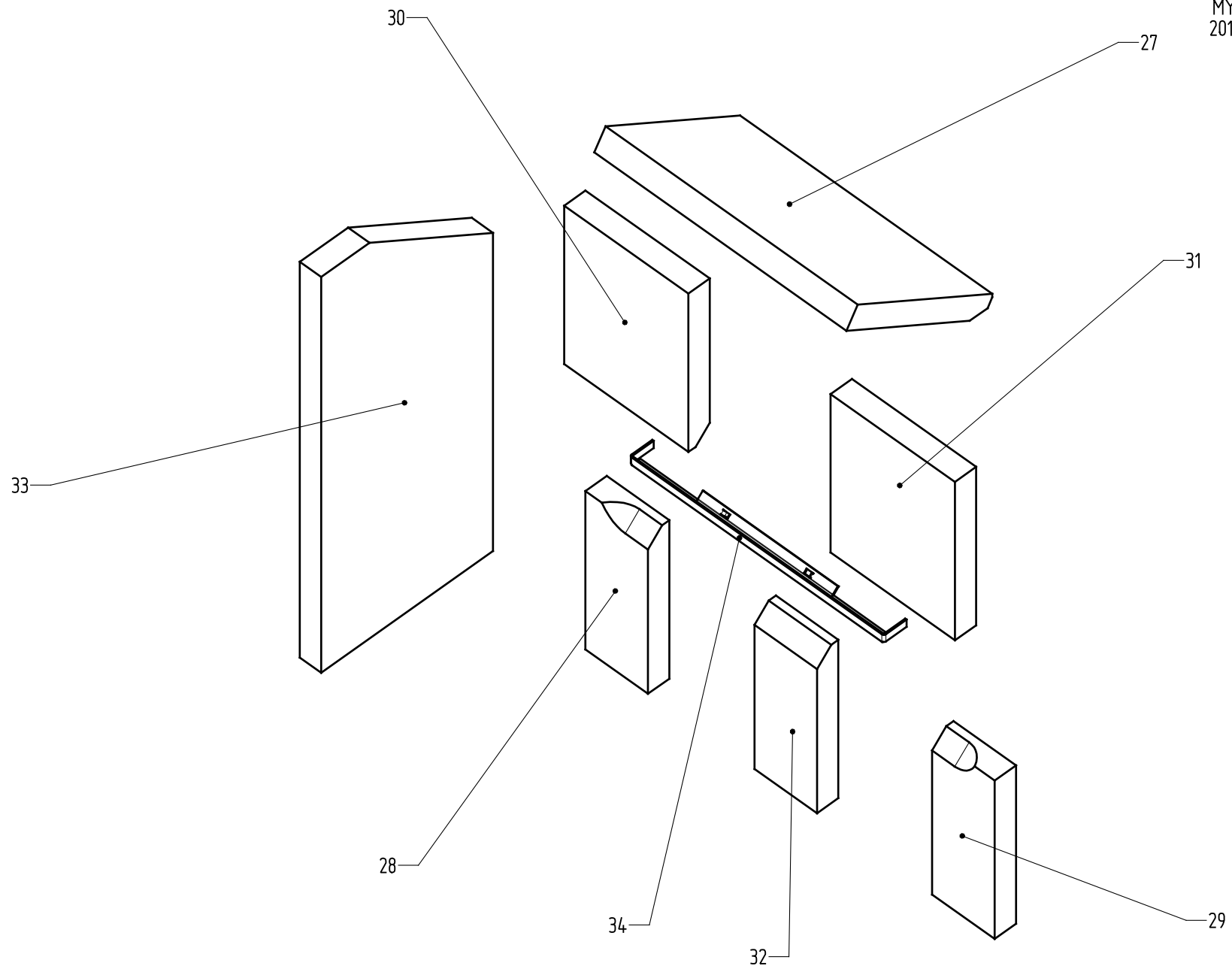

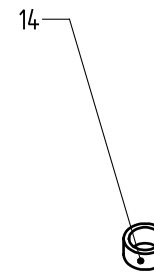
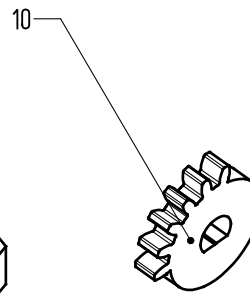
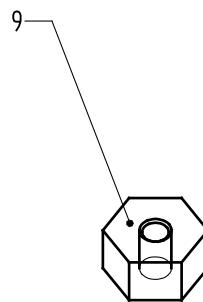
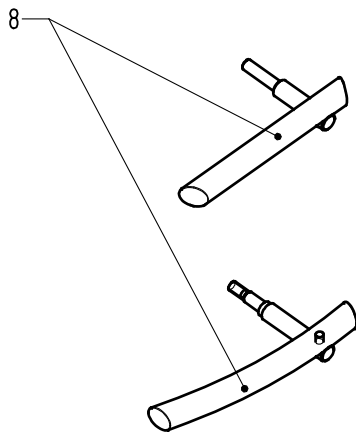
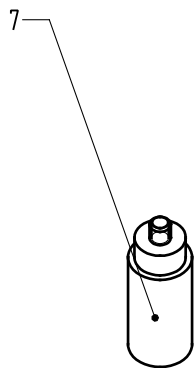
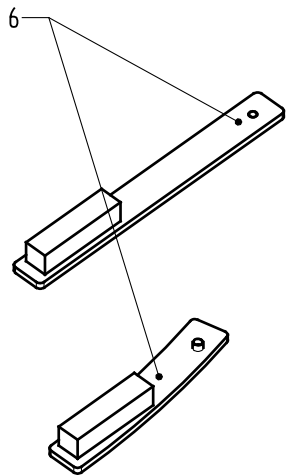
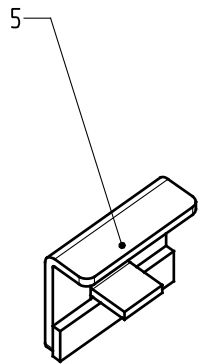

MYRA MYRO
2015.10.06.

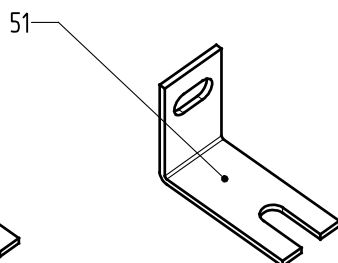
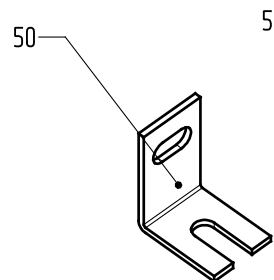
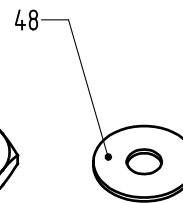
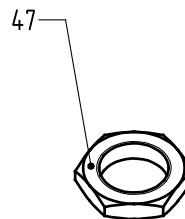
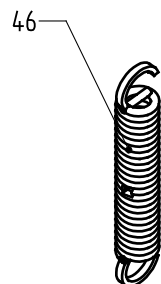
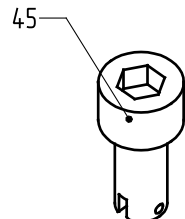
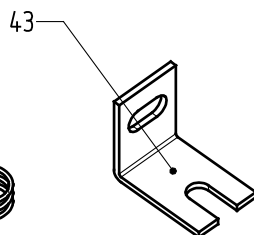
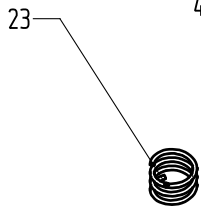
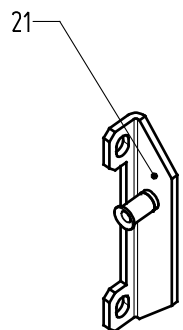

POS.	ARTIKELBEZEICHNUNG		ARTIKEL-NR.	PREIS-	TYP(EN)
Ssz.	MEGNEVEZÉS		KODSZAM	GRUPPE	TIPUS(OK)
1	HEIZTÜR LACK SCHWARZ MYRO	w	113718001	DB	A
1	AJTÓ FEST FEK (MYRO)	Sap	W5021901090094		
1	HEIZTÜR LACK SCHWARZ MYRA	w	113718002	GB	B
1	AJTÓ FEST FEK (MYRA)	Sap	W5021900480094		
2	DICHTSCHNUR D12 SCHWARZGRAU MIT HEZITÜR	w	011260003	JA/m	A,B
2	TÖMÍTŐZSINÓR AJTÓBA Ø12X2330	Sap	101116		
3	ROBAX GLAS 290X550X4	w	113718003	BB	A,B,
3	ROBAX ÜVEG 290X550X4	Sap	135102		
4	DICHTSCHNUR D6 SCHWARZGR. ASBESTFREI MIT GLAS	w	011260054	FA/m	A,B,
4	TÖMÍTŐZSINÓR ÜVEGHEZ Ø6X1550	Sap	115239		
5	HALTERBLECH F.GLAS GEKLEBT F.KAMINOFEN	w	108718621	EA	A,B,
5	ÜVEGRÖGZÍTŐ RAGASZTOTT KANDALLÓKHOZ	Sap	W5005401420020		
6	PRIMER LUFTREGLER LACK SCHWARZ MYRO	w	113718004	DA	A
6	PRIMER LEV SZAB FEST FEK (MYRO)	Sap	W5021901190094		
6	PRIMER LUFTREGLER GESCHWEIßT	w	113718005	DA	B
6	PRIMER LEV SZAB FEST FEK (MYRA)	Sap	W5021900700094		
7	LUFTREGLER KNOPF BRÜN MYRO MYRA	w	113718006	DA	A,B
7	LEV SZAB GOMB FORG BAR (MYRO MYRA)	Sap	W5021901280070		
8	GRIFF F. HEIZTÜR MONT MYRO	w	113718007	TA	A
8	FOGANTYÚ SZER (MYRO)	Sap	W5021901230020		
8	GRIFF F. HEIZTÜR MONT MYRA	w	113718008	VA	B
8	FOGANTYÚ SZER (MYRA)	Sap	W5021900780020		
9	SCHLIßELEMENT ABSTANDHALTER MYRO MYRA	w	113718009	DA	A,B
9	ZÁROELEM TÁVTARTÓ (MYRO)	Sap	W5021900690070		
10	ZAHNRAD MYRO MYRA	w	113718010	BA	A,B
10	FOGASKERÉK (MYRO MYRA)	Sap	W5021900760091		
11	SCHLIßELEMENT LACK SCHWARZ MYRO	w	113718011	IA	A
11	ZÁROELEM FEST FEK (MYRO)	Sap	W5021901210094		
12	SCHLIßELEMENT LACK SCHWARZ MYRA	w	113718012	IA	B
12	ZÁROELEM FEST FEK (MYRA)	Sap	W5021900720094		
13	LUFTLEITBLECH F.TÜR SCHWARZ MYRO MYRA	w	113718013	GA	A,B
13	LEV TER AJTÓBA FEST FEK (MYRO MYRA)	Sap	W5021901420094		
14	ROLLE FÜR SCHLOSS D8X1X4 DEL/VIS/LOF	w	101719057	EA	A,B,
14	GALA/GÖRGÖ 8x1x4 Z.CSAPHOZ /IF 613-215/	Sap	131024		

POS.	ARTIKELBEZEICHNUNG		ARTIKEL-NR.	PREIS-	TYP(EN)
Ssz.	MEGNEVEZÉS		KODSZAM	GRUPPE	TIPUS(OK)
15	DREHROST LACK SCHWARZ GG	w	108718173	KA	A,B
15	FORGÓROSTÉLY FEST FEK ÖV	Sap	W5019401580084		
16	ROSTLAGER GG SCHWARZ MYRO MYRA	w	113718014	PA	A,B
16	ROSTÉLYKERET ÖV FEST FEK (MYRO MYRA)	Sap	W5021900280084		
17	ASCHEKASTEN GESCHW MYRO MYRA	w	113718015	JA	A,B
17	HAMULÁDA HEG (MYRO MYRA)	Sap	W5021900250096		
18	RÜTTLERST F.ROST LACK GRAU	w	108718174	GA	A,B
18	ROSTÉLYRÁZÓ FEST SZÜR	Sap	W5019401590094		
19	ROSTRELING LACK SCHWARZ MYRO MYRA	w	113718016	JA	A,B
19	PARÁZSFOGÓ FEST FEK (MYRO MYRA)	Sap	W5021900850094		
20	SCHARNIERHALTER SCHWARZ MYRO	w	113718017	PA	A
20	ZSANÉRTARTO FEST FEK (MYRO)	Sap	W5021901390094		
20	SCHARNIERHALTER SCHWARZ MYRA	w	113718018	PA	B
20	ZSANÉRTARTO FEST FEK (MYRA)	Sap	W5021900190094		
21	SCHLOSS F.HEIZTÜR SCHWARZ MYRO MYRA	w	113718019	IA	A,B
21	ZÁRCSAP FEST FEK (MYRO MYRA)	Sap	W5021900230094		
22	BRENNSTOFFWÄHLER GESCHW SCHWAR	w	101717117	GA	A,B
22	TÜZELOANYAG VÁLASZTÓ FEST FEK	Sap	W5011204780094		
23	FEDER F.BRENNSTOFFWÄHLER BRÜNIERT	w	101718017	FA	A,B
23	LEVEGŐSZABÁLYZÓ RUGÓ 88X61	Sap	105393		
24	ROHRSTUTZEN D150, GG15 SCHUTZLACK	w	146111511	NA	A,B
24	FÜSTCSÓCSONK ÖV ÁTM150 FEST FEK	Sap	W501011151184		
25	BLINDBLECH F. BRENNRAUM SCHWAZ MEHRFACH	w	198717004	MA	A,B
25	TÜZTÉRTAKARÓ LEMEZ FEST FEK	Sap	W5016000570094		
26	VERMECULITE KPL. SETT 7+1 MYRO MYRA	w	113718020	DB	A,B
26	FALAZAT KPL. SZER 7+1 (MYRO MYRA)	Sap	W5021900820020		
27	STEIN ABGASFÜHRUNG ICON MYRA MYRO 445X226X30	w	113718021	PA	A,B
27	SAMÓTT LÁNGTERELŐ IDOM (ICON,MYRA,MYRO)	Sap	135104		
28	VERMECULITE HINTEN UNTEN LI 600-GAMMA 30X223X88	w	101716115	JA	A,B
28	VERMECULITE HÁTSÓ ALSÓ BAL 600-GAMMA 30X223X88	Sap	116947		
29	VERMECULITE HINTEN UNTEN RE 600-GAMMA 30X223X88	w	101716116	JA	A,B
29	VERMECULITE HÁTSÓ ALSÓ JOBB 600-GAMMA 30X223X88	Sap	116951		
30	VERMECULITE HINTEN OBEN LI 600-GAMMA 30X223X176	w	101717032	IA	A,B
30	VERMECULITE HÁTSÓ FELSŐ BAL 600-GAMMA 30X223X176	Sap	116945		

POS.	ARTIKELBEZEICHNUNG		ARTIKEL-NR.	PREIS-	TYP(EN)
Ssz.	MEGNEVEZÉS		KODSZAM	GRUPPE	TIPUS(OK)
31	VERMECULITE HINTEN OBEN RE 600-GAMMA 30X223X176	w	101717033	IA	A,B
31	VERMECULITE HÁTSÓ FELSŐ JOBB 600-GAMMA 30X223X176	Sap	116949		
32	VERMECULITE HINTEN MITTE 600-GAMMA 30X223X88	w	101716119	JA	A,B,
32	VERMECULITE HÁTSÓ KÖZÉP 600-GAMMA 30X223X88	Sap	116939		
33	VERMECULITE F.SEITE SF-600	w	113718022	OA	A,B,
33	VERMICULIT OLDAL SF-600	Sap	135105		
34	VERMECULITE HALTERBLECH F.RÜCKSTEIN GAMMA	w	101716041	RA	A,B
34	VERMECULITE TARTÓ HÓÁLLÓ ÉLH GAMMA	Sap	W5007202271099		
35	RÜCKWAND MYRO	w	113718023	NA	A
35	HÁTFAL ÉLH (MYRO)	Sap	W5021901070099		
35	RÜCKWAND MYRA	w	113718024	PA	B
35	HÁTFAL ÉLH (MYRA)	Sap	W5021900460099		
36	DECKPLATTE F.RÜCKWAND ECKIG STO 2 Z	w	101717002	JA	A,B
36	HÁTFALTAKARÓ(GA-045) SZÖGL/LYUK. ÁTM5,5/	Sap	W5009201190099		
37	MANTEL OBERTEIL SCHWARZ MYRO		113718025	SA	A
37	KÖPENYFELSŐ FEST FEK (MYRO)		W5021901010094		
37	MANTEL OBERTEIL SCHWARZ MYRA		113718026	WA	B
37	KÖPENYFELSŐ FEST FEK (MYRA)		W5021900370094		
38	SEITENVERKLEID. LI MONT M.NATURST MYRO	w	113718027	PB	A
38	OLDAL B.SZER NATÚRKÖVEL (MYRO)	Sap	W5021900930020		
38	SEITENVERKLEID. LI MONT M.NATURST MYRA	w	113718028	PB	B
38	OLDAL B.SZER NATÚRKÖVEL (MYRA)	Sap	W5021900290020		
39	SEITENVERKLEID. RE MONT M.NATURST MYRO	w	113718029	PB	A
39	OLDAL J.SZER NATÚRKÖVEL (MYRO)	Sap	W5021900930120		
39	SEITENVERKLEID. RE MONT M.NATURST MYRA	w	113718030	PB	B
39	OLDAL J.SZER NATÚRKÖVEL (MYRA)	Sap	W5021900290120		
40	SEITENVERKLEID. LI LACK SCHWARZ MYRO	w	113718031	WA	A
40	OLDAL B.FEST FEK (MYRO)	Sap	W5021900940094		
40	STEINHALTER LI LACK SCHWARZ MYRA	w	113718032	VA	B
40	KÖTARTO B FEST FEK (MYRA)	Sap	W5021900300094		
41	SEITENVERKLEID. RE LACK SCHWARZ MYRO	w	113718033	WA	A
41	OLDAL J.FEST FEK (MYRO)	Sap	W5021900940194		
41	STEINHALTER RE LACK SCHWARZ MYRA	w	113718034	VA	B
41	KÖTARTO J FEST FEK (MYRA)	Sap	W5021900300194		

POS.	ARTIKELBEZEICHNUNG		ARTIKEL-NR.	PREIS-	TYP(EN)
Ssz.	MEGNEVEZÉS		KODSZAM	GRUPPE	TIPUS(OK)
42	NATURSTEIN M.DÜBEL SEITE MYRO	w	113718035	FB	A
42	NATÚRKŐ OLDAL DÜBELEZETT (MYRO)	Sap	W5021900980020		
42	NATURSTEIN M.DÜBEL SEITE MYRA	w	113718036	KB	B
42	NATÚRKŐ OLDAL DÜBELEZETT (MYRA)	Sap	W5021900340020		
43	STEINHALTER UNTEN LACK SCHWARZ MYRO	w	113718037	DA	A
43	ALSÓ KÖRÖGZITŐ FEST FEK (MYRO)	Sap	W5021901030094		
44	NATURSTEIN M.DÜBEL UNTEN MYRO	w	113718038	GB	A
44	NATÚRKŐ ALSÓ DÜBELEZETT (MYRO)	Sap	W5021901040020		
44	NATURSTEIN M.DÜBEL UNTEN MYRA	w	113718039	NB	B
44	NATÚRKŐ ALSÓ DÜBELEZETT (MYRA)	Sap	W5021900420020		
45	AUFZIEHER FEDER F.HEIZTÜR	w	113717006	DA	A,B
45	RUGÓ FELHÚZÓ AJTÓHOZ	Sap	W5021600880070		
46	FEDER F.TÜRSCHARNIER 1,6	w	198717036	FA	A,B
46	HUZORUGO 1,6 WAMS.	Sap	116958		
47	SECHSKANTMUTTER FLACH M14X1	w	113718040	BA	B,
47	HL ALACSONY ANYA M14X1	Sap	W5021901430070		
48	UNTERLEGSCHIBE D18Xd6,2X1	w	113718041	AA	B
48	LEMEZALÁTÉT(LKS-002) ÁTM18/ÁTM6,2x1	Sap	W1102010099		
49	NATURSTEIN UNTEN MONT. MYRA	w	113718042	OB	B
49	ALSÓ NATÚRKŐ SZER (MYRA)	Sap	W5021901340020		
50	STEINHALTER UNTEN 1 LACK SCHWARZ MYRA	w	113718043	DA	B
50	ALSÓ KÖRÖGZITŐ 1 FEST FEK (MYRA)	Sap	W5021900400094		
51	STEINHALTER UNTEN 2 LACK SCHWARZ MYRA	w	113718044	DA	B
51	ALSÓ KÖRÖGZITŐ 2 FEST FEK (MYRA)	Sap	W5021900410094		
52	ABDECKBLECH F.UNTERE STEINHALTER MYRA	w	113718045	DA	B
52	TAKARÓ ALSÓ KÖHÖZ FEST FEK (MYRA)	Sap	W5021900450094		
53	RAUCHLOCHDECKEL D172X2 LACK SCHWARZ	w	113718046	EA	A,B
53	OR/KÖP FELSŐ(ORP-040)TAK LEM D172X2 FEK	Sap	W5007202180294		