

**ERSATZTEILLISTE
FÜR KAMINOFEN
TYP 18862_63 MONA**

ART.NR.	BEZEICHNUNG
G001886280	KF188-MONA KERAMIK-KAMINOF.5,8KW A.L.A
G001886290	KF188-MONA KERAMIK-BORDEAUX.5,8KW A.L.A
G001886370	TYP18863-MONA KERAMIK ANTIK WEIß 5,8KW
G001886390	TYP18863-MONA KERAMIK BORDEAUX 5,8KW

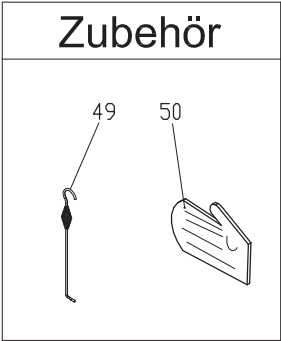







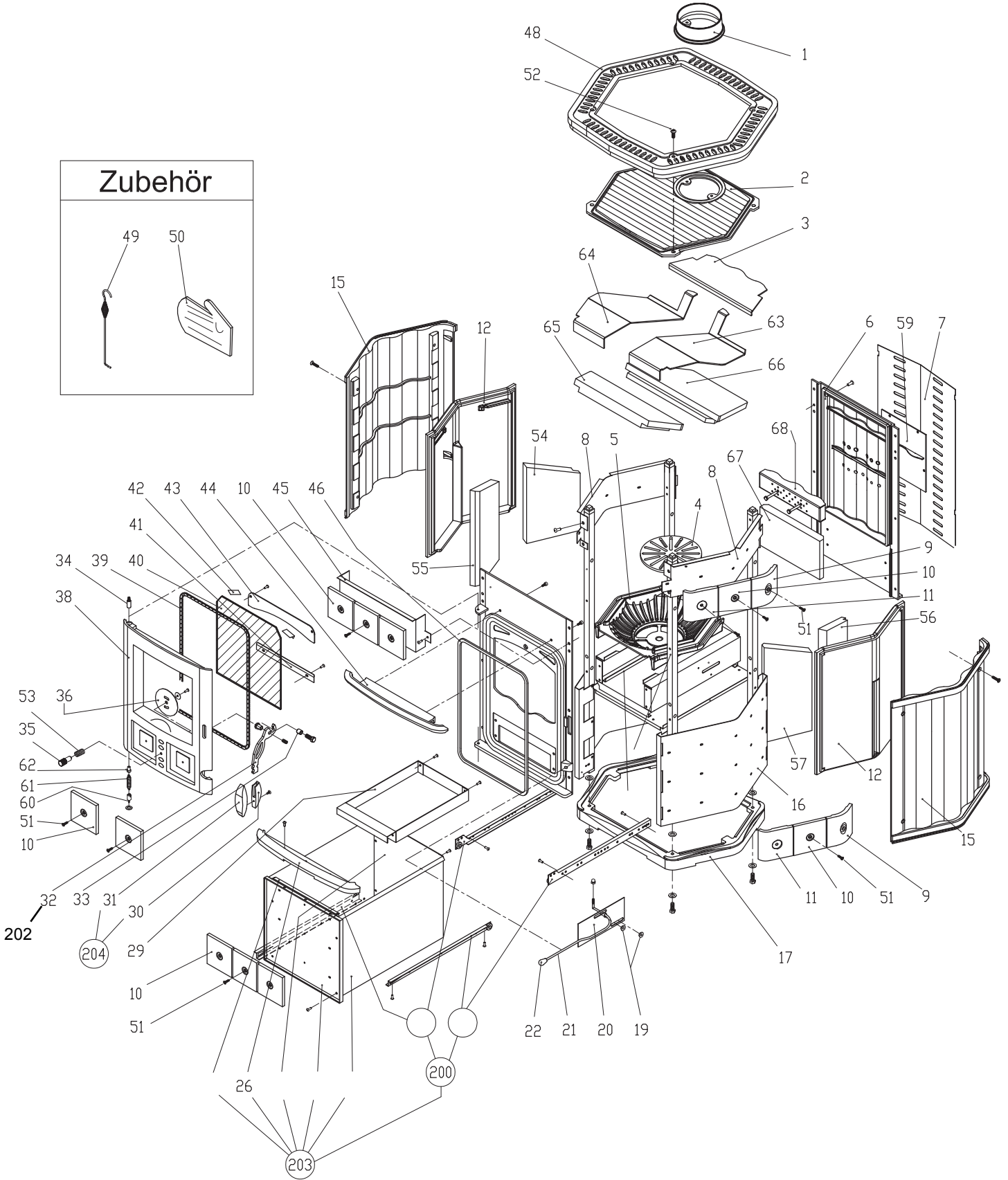













MONA /A























Zubehör



49 50



ZEICH. NR.	HTN-Mat. WAMSLER	BESCHREIBUNG MONA A G001886280	05.2015	EAN	SAP PG	GEWICHT kg	
1	H185710019	ABGASSTUTZEN 401.124.007 K185/KF188	1	4025144 950598	OA	0,88	
2	H188718101	ABDECKPLATTE GG 401.191.007 K188	1	4025144 964540	EB	6,00	
39	100252	DICHTSCHNUR D4 WEIß ASBESTFREI	2	4025144 901330	GA	0,002	
46	101117	DICHTSCHNUR D10 SCHWARZGR. ASB'FREI	3	4025144 961075	LA	0,002	
49	H185710110	SCHÜRHAKEN 077.077 KF188	1	4025144 951243	LA	0,077	
50	H185710111	HANDSCHUH 004.186 KF188/K185	1	4025144 951250	GA	0,038	
42	H185710122	SELBSTKLEB.GLASFASER BAND 10x3 004.105	2	4025144 951366	KA	0,002	
3	H188718102	ABGASUMLENKUNG 401.195 K188 A.L.A	±	4025144 964557	AB	ALT	
4	H188718103	ROST 401.186 KF188	1	4025144 964564	OA	1,00	
5	H188718104	FEUERMULDE 401.185 KF188 A.L.A	±	4025144 964571	DB	ALT	
6	H188718105	FEUERRAUM RÜCKWAND 401.184 KF188 A.L.A	±	4025144 964588	DB	ALT	
7	H188718106	FEUERRAUMSCHUTZBLECH HI 668.119 KF188	1	4025144 964595	PA	1,15	
8	H188718107	BEFESTIGUNGSBL F.KACHEL OB 672.018 KF188	2	4025144 964601	OA	0,45	
9	H188718108	KACHEL HINTEN GEBOGEN 004.103.106 COTTA	8	4025144 964618	MA	0,15	
10	H188718109	KACHEL FLACH 004.101.106 KF188 COTTA	30	4025144 964625	MA	0,15	
11	H188718110	KACHEL VORNE GEBOGEN 004.102.106 COTTA	16	4025144 964632	MA	0,15	
9	H188718172	KACHEL HINTEN GEBOGEN BORDEAUX	8	4025144 978196	JA	0,15	
10	H188718173	KACHEL FLACH BORDEAUX	30	4025144 978202	JA	0,15	
11	H188718174	KACHEL VORNE GEBOGEN BORDEAUX	16	4025144 978219	JA	0,15	
9	H188718175	KACHEL HINT.GEBOGEN 004.103.006 WEIß	8	4025144 988331	LA	0,15	
10	H188718176	KACHEL FLACH 004.101.006 K188 WEIß KF188	30	4025144 988348	LA	0,15	
11	H188718177	KACHEL VORN.GEBOGEN 004.102.006 WEIß	16	4025144 988355	LA	0,15	
15	H188718112	OFENSEITENWAND RE/LI 401.181.007 KF188	2	4025144 964656	GB	11,50	
16	H188718113	BEFESTIGUNGSBL.F.KACHEL UN 672.017 KF188	2	4025144 964663	OA	1,56	
17	H188718114	SOCKEL 401.180.007 KF188	1	4025144 964670	DB	7,00	

ZEICH. NR.	HTN-Mat. WAMSLER	BESCHREIBUNG MONA A G001886280	05.2015	EAN	SAP PG	GEWICHT kg	
19	H188718115	LUFTREGISTRIERBUCHSE 101.098 KF188	2	4025144 964687	NA	0,002	
20	H188718116	LUFTKLAPPE 6 72.013 KF188	1	4025144 964694	HA	0,40	
21	H188718117	ASCHENRÜTTLERSTAB 502.208 KF188	1	4025144 964700	DA	0,07	
22	H188718118	KNOPF F.ASCHENRÜT.STAB 502.206 MESSING	1	4025144 964717	KA	0,04	
26	H188718119	GRIFF F.HOLZLAGERFACH 401.187.007 KF188	1	4025144 964724	QA	1,30	
29	H188718120	ASCHENFACH 668.135 KF188	1	4025144 964731	YA	0,80	
30	H188718121	PLASTIKUNTERTEIL F.TÜRGRIF 002.146 KF188	3	4025144 964748	GA	0,020	
31	H188718122	PLASTIKOBERTEIL F.TÜRGRIF 002.145 KF188	3	4025144 964755	GA	0,037	
32	H188718123	TÜRGRIF 645.048.809 KF188 MONA A.L.A.	1	4025144 964762	NA	0,12	
33	H188718124	VERSCHLUSSWALZE F.TÜR 502.205 KF188	1	4025144 964779	BA	0,01	
34	H188718125	BEFESTIGUNGSTIFT F.TÜR 502.214.801 KF188	1	4025144 964786	EA	0,012	
35	H188718126	EINSTELLUNGSKNOPF LUFT 502.215 MESSING	1	4025144 964793	NA	0,07	
36	H188718127	EINSTELLUNGSSCHEIBE LUFT 645.057 KF188	1	4025144 964809	IA	0,082	
38	H188718128	TÜR F.FEUERRAUM 401.182.007 KF188	1	4025144 964816	EB	6,80	
40	H188718129	KERAMIKGLAS 003.113 KF188-MONA	1	4025144 964823	EB	0,67	
41	H188718130	FESTIGUNGSBÜGEL F.GLAS UN 688.057 KF188	1	4025144 964830	HA	0,10	
43	H188718131	FESTIGUNGSBÜGEL F.GLAS OB 645.055 KF188	1	4025144 964847	JA	0,16	
45	H188718132	BEFESTIGUNGSBL F.KACHEL OB 672.019 KF188	1	4025144 964854	NA	0,40	
48	H188718133	GUßRAHMEN 401.192.007 KF188-MONA	1	4025144 964861	DB	6,00	
51	H188718134	SCHRAUBE 4,8x19 VERGOLDET 401.166 KF188	54	4025144 964878	AA	0,001	
52	H188718135	SCHRAUBE M8x20 BRÜNIERT 101.145 KF188	4	4025144 964885	AA	0,003	
53	H188718136	KLAPPENFEDER 104.028 KF188	1	4025144 964892	EA	0,002	
54	H188718137	STAB F.RAUCHKLAPPE 502.195 KF188 A.L.A	1	4025144 964908	NA	ALT	
55	H188718138	RAUCHKLAPPE 401.196 KF188 A.L.A	1	4025144 964915	NA	ALT	
56	H188718139	FLAMMUMLENKUNG INOX 690.010 KF188 A.L.A	1	4025144 964922	XA	ALT	
57	H188718140	BLECHTEIL HINTEN 672.029 KF188 MONA A.L.A	1	4025144 964939	JA	ALT	
59	H188718141	RAUCHABDECKUNG 401.198 KF188 A.L.A	2	4025144 964946	LA	ALT	

ZEICH. NR.	HTN-Mat. WAMSLER	BESCHREIBUNG MONA A G001886280	05.2015	EAN	SAP PG	GEWICHT kg	
60	H188718142	SCHARNIERSTIFT F.FEDER 502.216 KF188	1	4025144 964953	EA	0,02	
61	H188718143	TORSIONSFEDER 104.029 KF188	1	4025144 964960	HA	0,01	
62	H188718144	HALTESTIFFT F.FEDER 502.203 KF188	1	4025144 964977	EA	0,01	
200	H188718145	HOLZLAGERFACH AUSZUG KPL.006.012 KF188	1	4025144 964984	RA	0,40	
202	H188718178	TÜR GRIFF KOMPLETT KF188 MONA 000.187	1	4025144 994875	SA	0,13	
203	H188718146	HOLZLAGERFACH KPL. 500.051 KF188	1	4025144 964991	DB	0,015	
204	H188718147	PLASTIKGRIFF KPL. 000.158 KF188	3	4025144 965004	KA	0,06	
3	H188718148	ABGASUMLENKUNGSBLECH OBEN KF188	1	4025144 971036	QA	0,80	
5	H188718149	FEUERMULDE MONA A COTTA 340.011.01 KF188	1	4025144 971043	CB	8,54	
6	H188718150	FEUERRAUM RÜCKWAND 340.012.03 KF188	1	4025144 971050	GB	10,96	
12	H188718151	FEUERRAUM SEITENW RE/LI 340.012.02 KF188	2	4025144 971067	DB	8,90	
54	H188718152	VERMIKULITPL. SEITL.HINTEN LI KF188-MONA	1	4025144 971074	TA	0,65	
55	H188718153	VERMIKULITPL.SEITL. VORNE LI. KF188-MONA	1	4025144 971081	TA	0,76	
56	H188718154	VERMIKULITPL.SEITL. HINTEN RE KF188-MONA	1	4025144 971098	SA	0,63	
57	H188718155	VERMIKULITPL.SEITL. VORNE RE KF188-MONA	1	4025144 971104	TA	0,76	
59	H188718156	BLECHTEIL OFEN HINTEN KF188-MONA COTTA	1	4025144 971111	QA	0,41	
63	H188718157	ABGASUMLENKUNGSBLECH MITTE RE KF188	1	4025144 971128	TA	1,43	
64	H188718158	ABGASUMLENKUNGSBLECH MITTE LI KF188	1	4025144 971135	TA	1,43	
65	H188718159	VERMIKULITPLATTE OBEN VORNE KF188	1	4025144 971142	VA	0,70	
66	H188718160	VERMIKULITPLATTE OBEN HINTEN KF188	1	4025144 971159	YA	1,28	
67	H188718161	VERMIKULITPLATTE HINTEN KF188	1	4025144 971166	RA	0,56	
68	H188718162	SEKUNDÄRLUFT BLECH 260.244.00 KF188	1	4025144 971173	PA	0,30	

STAND 05.2015