

**ERSATZTEILLISTE
FÜR KAMINOFEN
TYP 18871_73 ROMANTIK B**

ART.NR.	BEZEICHNUNG
G001887180	KF188-ROMANTIC-B/A KER.BORDE 7,5KW A.L.A
G001887185	KF188-ROMANTIC-B/A SPECKST. 7,5KW A.L.A
G001887385	TYP18873-ROMANTIC-B/A NATURSTEIN 7,5KW
G001887386	TYP18873-ROMANTIC-B/A NATURSTEIN 7,5KW

ROMANTIC B / A

Romantic B/A NATURSTEIN

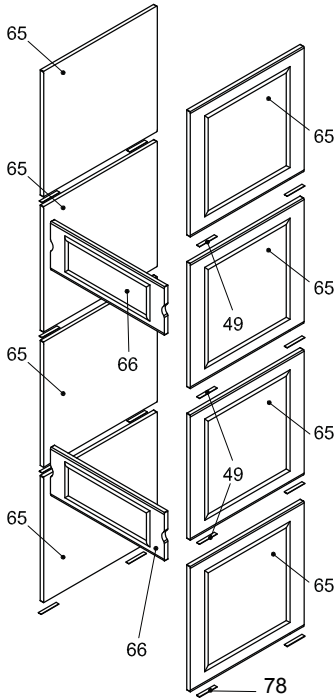



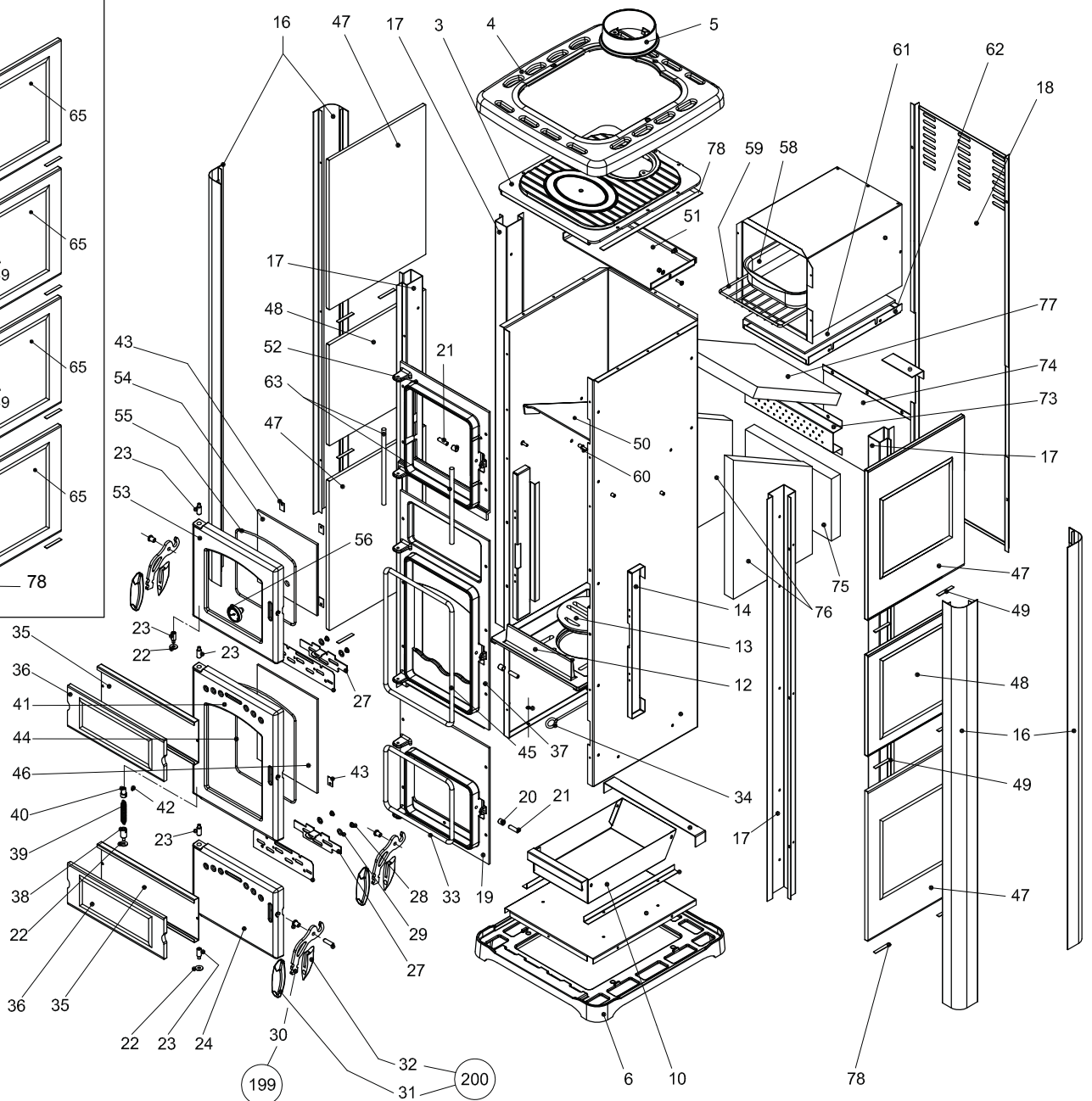



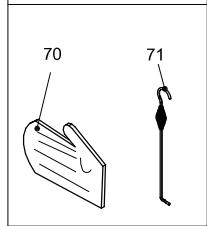











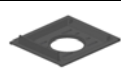























Romantic B/A Keramik



Zubehöre



ZEICH. NR	HTN-Mat. WAMSLER	BESCHREIBUNG ROMANTIK B / A	05.2015	GEWICHT kg	EAN	SAP PG	
33-45-63	101117	DICHTSCHNUR D4 WEIß ASBESTFREI		0,012	4025144901330	BA	
44-55	100252	DICHTSCHNUR D10 SCHWARZGR. ASB'FREI		0,050	4025144961075	GA	
49	H185710008	SILIKONDICHTUNG 102.098 KF188/K185		0,001	4025144960054	NA	
5	H185710019	ABGASSTUTZEN 401.124.007 K185/KF188		0,900	4025144950598	OA	
71	H185710110	SCHÜRHAKEN 077.077 KF188		0,077	4025144951243	LA	
70	H185710111	HANDSCHUH 004.186 KF188/K185		0,038	4025144951250	LA	
3	H188716001	ABDECKPLATTE GG 401.235.007 KF188		5,700	4025144965011	DB	
4	H188716002	GUßRAHMEN GG 401.236.007 KF188		5,300	4025144965028	CB	
6	H188716003	SOCKEL 401.243.007 KF188		5,200	4025144965035	DB	
10	H188716004	ASCHENFACH 668.181 KF188		0,750	4025144965042	VA	
12	H188716005	ROSTHALTER 401.109 KF188		6,000	4025144965059	CB	
13	H188716006	FEUERROST GG 401.044 KF188		0,900	4025144965066	NA	
15	H188716007	GUßSEITEN RÜCKWAND 401.103/A KF188 A.L.A.		3,000	4025144965073	DB	
16	H188716008	FLAMMUMLEMKUNG 645.148.1 KF188		1,300	4025144965080	YA	
17	H188716009	RAUCHUMLENKUNGSBLECH 645.149.1 KF188		1,200	4025144965097	RA	
16	H188716010	SEITENPROFIL 658.106.900 KF188		1,200	4025144965103	UA	
17	H188716011	SEITENPFOSTEN 672.045 KF188		1,650	4025144965110	AB	
18	H188716012	HINTERBLECH 668.177 KF188		2,324	4025144965127	AB	
19	H188716013	VORDERWAND UNTEN 401.237.007 KF188		3,600	4025144965134	BB	
21	H188716014	ZAPFEN M8x30 101.161 KF188		0,008	4025144965141	KA	
22	H188716015	SCHEIBE D18x6,5x1,6 102.004 KF188		0,005	4025144965158	AA	
24	H188716016	TÜR F.ASCHENFACH 401.240.007-A KF188		3,400	4025144965165	YA	
27	H188716017	LUFTHEBEL 645.151.803 KF188		0,077	4025144965172	MA	
28	H188716018	LUFTREGISTRIERBUCH 103.060.801 KF188		0,002	4025144965189	DA	

ZEICH. NR	HTN-Mat. WAMSLER	BESCHREIBUNG ROMANTIK B / A	05.2015	GEWICHT kg	EAN	SAP PG	
29	H188716019	FLACHSCHEIBE D10x6,5x1,6 102.074 KF188		0,002	4025144965196	AA	
30	H188716020	GRIFF F.TÜR 645.150.803 KF188 ALA		0,133	4025144965202	PA	
34	H188716021	STAB F.ASCHENRÜTTLER 502.117 KF188		0,063	4025144965219	FA	
35	H188716022	HALTERBLE.F.KERA.VORNE 658.104.900 KF188		0,350	4025144965226	UA	
36	H188716023	KERAMIKPL.VORNE BORD.462509 KF188bis2012		0,640	4025144965233	TA	
37	H188716024	VORDERWAND OBEN 401.238.007 KF188		6,000	4025144965240	EB	
41	H188716025	TÜR F.FEUERRAUM 401.241.007 KF188		4,300	4025144965257	DB	
42	H188716026	ZAPFEN M5x6 101.001 KF188		0,002	4025144965264	AA	
43	H188716027	SCHEIBE F.GLASBEFESTIGUNG 690.022 KF188		0,002	4025144965271	AA	
46	H188716028	GLAS F.FEUERRAUM 003.122 KF188		0,550	4025144965288	BB	
47	H188716029	KERAMIK F.SEITE H.430 004.160.509 KF188 ALT		2,180	4025144965295	AB	
52	H188716035	VORDERWAND F.BACKFACH 401.239.007 KF188		3,200	4025144967756	BB	
53	H188716036	BACKFACHTÜR 401.242.007 KF188		3,250	4025144967763	BB	
54	H188716037	GLAS F.BACKFACHTÜR 003.123 KF188		0,490	4025144967770	PA	
56	H188716038	THERMOMETER 008.032 KF188		0,038	4025144967787	SA	
58	H188716039	BACKBLECH 637.107 KF188		0,146	4025144967794	OA	
59	H188716040	BRATROST 001.087 KF188		0,274	4025144967800	MA	
61	H188716042	BACKFACH ISO.PLATTE UNTEN 004.132 KF188		0,080	4025144967824	KA	
14	H188716045	SCHAMOTTHALTER SEITENBL.260.702.16 KF188		0,300	4025144969262	NA	
50	H188716046	U.RAUCHUMLENKUNGSBLECH 260.610.20 KF188		2,140	4025144969279	VA	
73	H188716047	SEKUNDERLUFT BLECH 260.702.15 KF188		0,500	4025144969286	QA	
74	H188716048	SEKUNDERLUFT KAMIN BL. 260.406.15 KF188		0,536	4025144969293	NA	

ZEICH. NR	HTN-Mat. WAMSLER	BESCHREIBUNG ROMANTIK B / A	05.2015	GEWICHT kg	EAN	SAP PG	
75	H188716049	SCHAMOTTPLATTE UN/HI 380.424.20 KF188		1,100	4025144969309	TA	
76	H188716050	SCHAMOTTPLATTE SEITE 380.424.22 KF188		1,720	4025144969316	XA	
77	H188716051	SCHAMOTTPLATE OBEN 380.424.21 KF188		2,070	4025144969323	YA	
60	H188716052	NIETE M5 L.15 120.111 KF188		0,003	4025144969330	DA	
78	H188716053	FLACHDICHTUNG F.GUSSRAHMEN 004.105 KF188		0,001	4025144969347	KA	
62	H188716054	U.BACKFACH.SCHUTZBLECH 260.218.01 KF188		0,775	4025144969354	UA	
51	H188716055	OBERES RAUCHUMLENKBLECH 260.610.22 KF188		1,230	4025144969361	SA	
65	H188716056	SERPENTINOPLATTE SEITE 004.163.017 KF188		3,600	4025144978349	YA	
66	H188716057	SERPENTINOPLATTE VORNE 001.164.017 KF188		1,420	4025144978356	VA	
32	H188718121	PLASTIKUNTERTEIL F.TÜRGRIF 002.146 KF188		0,020	4025144964748	GA	
31	H188718122	PLASTIKOBERTEIL F.TÜRGRIF 002.145 KF188		0,037	4025144964755	GA	
20	H188718124	VERSCHLUSSWALZE F.TÜR 502.205 KF188		0,001	4025144964779	BA	
23	H188718125	BEFESTIGUNGSTIFT F.TÜR 502.214.801 KF188		0,012	4025144964786	EA	
38	H188718142	SCHARNIERSTIFT F.FEDER 502.216 KF188		0,002	4025144964953	EA	
39	H188718143	TORSIONSFEDER 104.029 KF188		0,001	4025144964960	HA	
40	H188718144	HALTESTIFFT F.FEDER 502.203 KF188		0,001	4025144964977	EA	
199	H188716064	KOMPLETT TÜRGRIF ROMANTIC 000.186 KF188		0,134	4025144994844	RA	
200	H188718147	PLASTIKGRIFF KPL. 000.158 KF188		0,060	4025144965004	KA	

STAND 05.2015