



Harworth Heating Ltd
01302 742520

oilspares.co.uk

Price List

Issue 55 - April 07

Section #	Section Name	Page
1	Bubble Stove Accessories	2-3
2	Flue and Chimney	6
3	Heat Resistant Materials	7-8
4	Oil Line Spares	9-11
5	Oil Tanks	12
6	Oil Tank Spares	13
7	Plumbing Components	14-16
8	Power Supplies	17
9	Pressure Jet Burner	18-20
10	Temperature Control	21
11	Time Clock	22
12	Test Equipment	23
13	Vaporising Oil	24-26

Retail prices quoted in this list includes VAT

Part No	Description	Price
---------	-------------	-------

Accessories



77-02-635	Tippy ash carrier to suit Corner Bubble and Squirrel stove	£35.00 C
77-02-637	Fire guard to suit corner stove	£117.50 C
77-02-636	Flue guard to suit boat flue pipe polished s/s with holes	£79.90 C
77-02-636-A	Flue guard to suit boat flue pipe s/s no holes	£79.90 C
87-01-850-37	Round Bubble matt black drip tray complete (note that this tray is now supplied with the stove)	£51.77 C
87-01-501-DT	Boat Bubble 1 drip tray	£51.77 C
87-01-550-7	Corner Oil Bubble 1 drip tray (supplied with stove)	£51.77 C
87-01-501-25	Bubble 1 and Boat Bubble 1 fixing brackets (bolts onto real legs)	£2.35 C
87-01-600-DT	Bubble 2 drip tray	£61.77 C
87-01-550-7A	Corner Oil Bubble 1 & Bubble 2 fixing brackets (hooks onto front of drip tray, brackets are supplied with the stove)	£2.35 C
87-01-450-3A	Corner Solid Fuel Bubble fixing brackets (hooks onto front of drip tray, not supplied with the stove)	£2.35 C
87-01-850-38	Round Bubble decorative side panels complete (matt black)	£70.50 C
110404-B	BB1 - B1 & Corner stoves door hing pin	£1.99 C
110405-B	B2 door hing pin	£2.00 C
77-01-940	Bubble 1 door rope kit	£10.19 C
77-01-941	Boat Bubble 1 door rope kit	£10.19 C
77-01-942	Corner Oil Bubble door rope kit	£13.43 C
77-01-943	Corner Solid Fuel Bubble door rope kit	£13.43 C
77-01-944	Bubble 2 door rope kit	£16.69 C
77-01-945	Bubble 3 door rope kit	£16.69 C
77-01-946	Corner oil B1 & BB1 door & glass rope kit	£14.89 C
77-01-947	Corner solid fuel door & glass rope kit	£16.99 C
92-20-200	Bubble 1 and Boat Bubble 1 coal kit	£94.00 D
92-20-215	Corner Bubble 1 coal kit	£96.33 D
92-20-205	Bubble 2 coal kit	£119.06 D
92-20-260	Bubble 2 Inset coal kit	£119.06 D
92-20-210	Bubble 3 coal kit	£141.00 D

Fiddle Rails



92-40-070	Bubble 1 fiddle rail kit	£81.91 D
92-50-070	Bubble 2 fiddle rail kit	£93.66 D



Fireplaces

87-01-451 Corner Fireplace to suit solid fuel and oil stove

£294.97 C



Infill Panels

87-04-500 Fibre board sides suitable to paint (Micatech 25 x 610 x 1000 mm)

£29.25 C

77-01-622 Tac board suitable to tile & paint. Set of two for corner fire place

£49.94 C

77-01-620 Tac board 8ft x 4ft sheet

£110.50 C

87-01-553 Stainless panel pair to suit corner fireplace

£152.75 C

87-01-554 Polished brass panel pair to suit corner fireplace

£227.65 C

87-01-555 Copper panel pair to suit corner fireplace

£250.00 C

Part No	Description	Price
---------	-------------	-------



Anti-Downdraft Terminals

77-02-451	Swinging anti-downdraft cowl, 4" diameter for oil and multi-fuel stoves	£49.00 C
77-02-495	Swinging anti-downdraft cowl, 5" diameter for oil and multi-fuel stoves, for 28" above deck extension	£56.79 C
77-02-593	Swinging anti-downdraft cowl, 6" diameter for oil and multi-fuel stoves, for 12" above deck extension	£79.05 C
77-02-442	4" rosette matt black	£15.36 C



Barometric Damper

78-01-200	125 mm (5") Draft Regulator	£9.11 C
78-01-210	150 mm (6") Draft Regulator	£29.01 C



Ceiling Plate

87-01-550-FSR	Ceiling ring for 88.9 & 100mm flue pipe - stainless	£16.57 C
---------------	---	----------

Chimney Terminals

77-02-640	Standard black terminal for oil stoves to suit 77-02-663 but not 77-02-634	£15.43 C
-----------	--	----------

Deck Flange covers

77-02-822	Deck Flange covers galvanised steel solid top perforated sides	£20.63 C
77-02-823	Deck Flange covers galvanised steel solid top solid sides to suit our above deck extentions 12" & 28"	£22.18 C

Deck Flange

77-02-405	5" Deck flange	£97.16 C
-----------	----------------	----------

Deck Flange Kits

To Suit Traditional Above Deck Chimney Extensions see 77-02-633 and 634

77-02-820	To suit internal flue pipe diameter 88.9 mm	£150.68 C
77-02-821	To suit internal flue pipe diameter 100 mm	£150.68 C



To Suit New Style Insulated Twin Wall Chimney Extensions

77-02-821A	To suit internal flue pipe diameter 100 mm	£123.19 C
77-02-821B	To suit internal flue pipe diameter 125 mm	£123.19 C

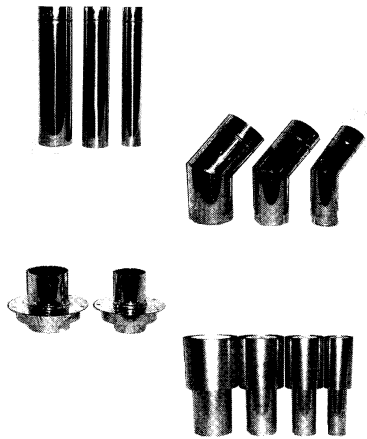

Glembing Stainless Steel Chimney Systems: 70 mm Diameter

Single Skin

77-02-670	1000 mm straight length	£46.06 C
77-02-674	500 mm straight length	£27.79 C
77-02-678	90 degree elbow	£44.58 C
77-02-682	45 degree elbow	£57.29 C
77-02-705	30 dg ree elbow	£52.04 C
77-02-686	1000 mm stainless mesh flue guard	£26.20 C
77-02-689	500 mm stainless mesh flue guard	£20.60 C
77-02-693	Deck flange to suit 70 mm flue	£107.27 C
77-02-695	Cover for deck penetration unit	£22.50 C
77-02-697	Trim for deck penetration unit	£13.20 C
77-02-699	Cylindrical terminal	£89.67 C
77-02-701	H-formed terminal	£93.10 C
77-02-691	250 mm sleeve	£22.87 C

Glembing Stainless Steel Chimney Systems: 70 mm Diameter

Insulated

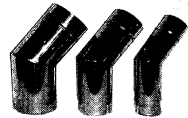

77-02-671	1000 mm straight length	£110.98 C
77-02-675	500 mm straight length	£71.81 C
77-02-679	90 degree elbow	£79.64 C
77-02-683	45 degree elbow	£79.64 C

Glembing Stainless Steel Chimney Systems: 90 mm Diameter

Single Skin

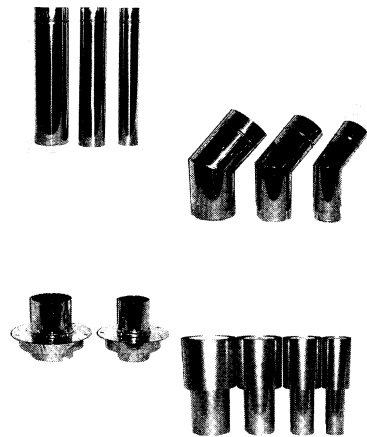

77-02-672	1000 mm straight length	£41.13 C
77-02-676	500 mm straight length	£25.85 C
77-02-680	90 degree elbow	£44.51 C
77-02-684	45 degree elbow	£44.51 C
77-02-704	30 degree elbow	£70.33 C
77-02-706	15 degree elbow	£68.41 C
77-02-687	1000 mm stainless mesh flue guard	£30.40 C
77-02-690	500 mm stainless mesh flue guard	£23.87 C
77-02-694	Deck flange to suit 90 mm flue	£93.73 C
77-02-696	Cover for deck penetration unit	£21.98 C
77-02-698	Trim for deck penetration unit	£16.10 C
77-02-700	Cylindrical terminal	£96.82 C

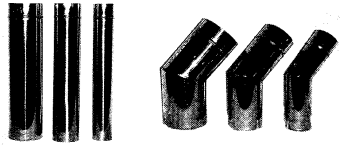

Glebring Stainless Steel Chimney Systems: 90 mm Diameter

Insulated

77-02-673	1000 mm straight length	£116.33 C
77-02-677	500 mm straight length	£71.09 C
77-02-681	90 degree elbow	£81.62 C
77-02-685	45 degree elbow	£82.70 C

Heavy Duty Weldable Steel Flue Pipe



77-02-400	90 mm diameter x 1.7 m for oil and multi-fuel stoves	£45.73 C
77-02-401	100 mm diameter x 1.7 m for oil and multi-fuel stoves (suitable for Belfort)	£58.29 C
77-02-638	Adaptor for use with Morso & Little Wenlock stoves and 100mm flue pipe	£11.75 C

Heavy Duty Weldable Stainless Steel Flue Pipe

77-02-641	90 mm diameter x 1.7 m for oil and multi-fuel stoves	£107.06 C
77-02-642	100 mm diameter x 1.7 m for oil and multi-fuel stoves	£125.47 C
77-02-642A	100 mm x 1.7m 18g polished stainless steel flue	£187.13 C



Traditional Above Deck Chimney Extensions 6" Diameter

77-02-633	Long traditional above deck chimney extension: 28" for oil and multi-fuel stoves, suitable for house boats	£84.94 C
77-02-634	Short traditional above deck chimney extension: 12" for oil and multi-fuel stoves, mainly for cruising	£54.84 C

New Style, High Performance Insulated Twin Wall Chimney Extensions

The new style chimneys can be extended by means of a simple twist lock joining system.

77-02-321	Fully Insulated High Performance Short Above Deck Chimney Ext 12" For appliances needing chimney of 4" diameter	£87.23 C
77-02-320	Fully Insulated High Performance Long Above Deck Chimney Ext 20" For appliances needing chimney of 4" diameter	£116.95 C
77-02-903	Fully Insulated High Performance Short Above Deck Chimney Ext 12" For appliances needing chimney of 5" diameter	£99.42 C
77-02-902	Fully Insulated High Performance Long Above Deck Chimney Ext 20" For appliances needing chimney of 5" diameter	£116.95 C

New Style Standard Twist Lock Chimney Terminals

77-02-313	To Suit 4" Flue (5" Insulated above deck.)	£42.30 C
77-02-928	To Suit 5" Flue (6" Insulated above deck.)	£44.09 C

Part No	Description	Price
---------	-------------	-------

Ceramic Paper Gasket 3 mm

77-01-904	Ceramic felt 12" x 12"	£10.00 C
-----------	------------------------	----------

**Fire Cement**

77-01-960	1 kg natural	£7.05 C
77-01-957	1 kg black	£7.05 C
77-01-959	3 kg natural	£17.63 C
77-01-961	6 kg natural	£22.00 C

Glass

87-01-430	Round Bubble one piece mica panel	£4.56 C
87-01-433	Round Bubble glass	£5.75 C
188798-B	Bubble 1 and Corner Oil Bubble one piece glass panel	£41.96 C
188798-B	Corner Solid Fuel one piece glass panel	£41.96 C
188779-B	Bubble 2 and Bubble 2 Inset one piece glass panel	£41.70 C
188780-B	Bubble 3 one piece glass panel	£68.87 C
259015-B	B1/2 Squares to hold glass (4 required for each door)	£1.22 C
77-03-017	Screws to hold squares (259015- 4 for each door)	£0.18 C
142881-B	Gasket for door glass (4 for each door)	£0.63 C

Glass Fibre Rope: Self-Adhesive

77-01-916	12 mm x 1 m self-adhesive door seal	£1.30 C
-----------	-------------------------------------	---------

**Glass Fibre Rope: Flat**

77-01-919	Glazing tape 15 mm x 3 mm x 25 m	£31.52 C
77-01-920	Glass fibre flat ladder rope 15 mm x 3 mm (rope seal for door glass edging)	£3.13 C

**Glass Fibre Rope: Round**

77-01-908	3 mm diameter x 1 m	£6.50 C
77-01-910	8 mm diameter x 1 m	£6.50 C
77-01-912	9 mm diameter x 1 m	£6.50 C
77-01-914	12 mm diameter x 1 m	£6.50 C
77-01-918	14 mm diameter x 1 m	£6.50 C
77-01-922	20 mm diameter x 1 m	£6.50 C



Glass Fibre Rope Ending Tape

77-01-905 25 mm x 55 m

£39.16 :C



Heat Resistant Board

87-04-500 Micatech 25 x 610 x 1000 mm

£29.25 C

87-04-500B Vicuclad 50 x 610 x 1000 mm

£43.05 C

77-01-625 Tac board 10 mm thick. Cut to size, price per square metre

£28.25 C

77-01-630 Tac Board 9MM 4FT X 2FT nominal panel - W72

£28.46 C

High Temperature Adhesive

77-01-965 Ceramic rope adhesive

£3.69 C

77-01-971 High temperature linear sealant
300 ml cartridge to fit applicator gun

£12.92 C



High Temperature Paints

77-01-966 200 ml tin: black

£13.29 C

77-01-950 400 ml aerosol: black

£8.48 C

77-01-952 400 ml aerosol: forest green

£13.32 C

Insulation

77-07-028 PJ chimney wrap insulation 387mm wide x 495mm long

£52.04 C



P Section Rope

77-01-930 P section rope, per foot

£7.83 C

Part No	Description	Price
---------	-------------	-------

Compression Fittings

77-01-706	1/4" BSPT to 10 mm adaptor	£3.51 C
77-01-705	1/4" BSPT to 8 mm adaptor	£3.07 C
77-01-727	1/2" BSP brass hexagonal nipple (6582)	£2.42 C
77-01-728	1/2" X 3/8" MXM reducing nipple brass HEX	£1.75 C
77-01-710	3/8" BSPT to 8 mm adaptor	£3.16 C
77-01-711	3/8" BSPT to 10 mm adaptor	£3.57 C
77-01-723	10 mm - 10 mm straight compression	£3.24 C
77-01-717	8 mm - 8 mm straight compression	£2.57 C
77-01-724	10 mm - 10 mm 90 degree compression elbow	£1.73 C
77-01-718	8 mm - 8 mm 90 degree compression elbow	£2.68 C
77-01-720	10 mm compression bulkhead fitting	£8.04 C
77-01-719	8 mm compression bulkhead fitting	£4.89 C
77-01-725	10 mm to 8 mm compression reducer	£4.18 C
77-01-742	14" BSPT to 1/4" BSPT male adaptor (6580)	£0.94 C
77-01-713	3/8" BSPT to 3/8" BSPT male adaptor	£1.28 C
77-01-747	1/2" BSPT to 1/2" BSPT iron socket female	£3.49 C
77-01-764	10 mm diameter soft copper price per metre	£2.01 C

**Filters**

77-07-006B	Filter with aluminium bowl and washable cartridge (3/8" BSP female)	£13.24 C
77-07-005	19489 Crosslands filter complete	£28.83 C
77-07-005-1	19493 Crosslands filter complete	£30.44 C

Fire Valves: 1/4" BSP Female Each End, Remote Sensing KBB & PTFV

77-07-004-A	1.5M KBB FIRE VALVE 65 DG C (10810)	£56.96 C
77-07-004-J	12.0M KBB FIRE VALVE 65 DG (13371)	£134.81 C
77-07-004-B	6.0M KBB FIRE VALVE 65 DG C (10813)	£63.97 C
77-07-004-H	6.0M KBB FIRE VALVE 90 DG C	£66.05 C
77-07-004-D	9.0M KBB FIRE VALVE 65 DG (10814)	£73.41 C
77-07-004-K	1.5M PTFV FIRE VALVE 65 DG C	£36.81 C
77-07-004-P	12M PTFV FIRE VALVE 90 DG C	£71.60 C
77-07-004-L	3.0M PTFV FIRE VALVE 65 DG C	£40.61 C
77-07-004-M	3.0M PTFV FIRE VALVE 90 DG C	£62.76 C
77-07-004-N	6.0M PTFV FIRE VALVE 90 DG C	£69.23 C
77-07-004-O	9.0M PTFV FIRE VALVE 90 DG C	£71.60 C

Fire Value Fusable Head

77-07-004-1 FV1800 10mm Fire value fusable head £17.87 C

Flexible Oil Hoses for Pressure Jet Burners

TYPE "G" END

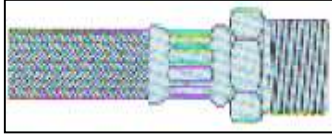

77-01-017-I	Flexible Oil Burner Hose 800mm G 1/8" x A 1/4"	£8.25 C
77-01-017-F	Flexible Oil Burner Hose 800mm G 1/4" x A 1/4"	£8.25 C
183001	Flexible Oil Burner Hose 1300mm G 1/4" x A 1/4" Gretalux Burners	£16.56 C
77-01-017-N	Flexible Oil Burner Hose 800mm G 3/8" x A 3/8"	£8.25 C

TYPE "A" END

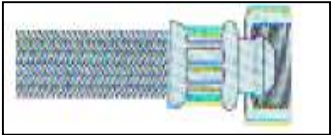

77-01-017-K	Flexible Oil Burner Hose 800mm A 1/4" x A 1/4"	£8.25 C
77-01-017	Flexible Oil Burner Hose 700mm A 3/8" x G 1/4"	£12.80 C
77-01-017-G	Flexible Oil Burner Hose 800mm A 3/8" x G 3/8"	£8.25 C

TYPE "K" END

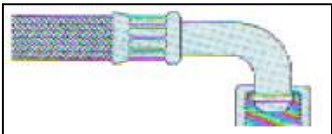

77-01-017-Q	Flexible Oil Burner Hose 400mm K 1/8" x A 1/8" high pressure long life.	£17.33 C
77-01-017-E	Flexible Oil Burner Hose 800mm K 1/4" x A 1/4"	£8.25 C
77-01-017-P	Flexible Oil Burner Hose 800mm K 1/4" x G 1/4"	£10.38 C

TYPE "B" END

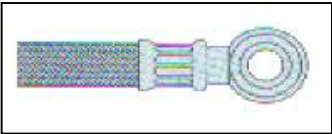

77-01-017-L	Flexible Oil Burner Hose 800mm BANJO (B) 10 x A 1/4"	£8.25 C
-------------	--	---------

TYPE "M" END

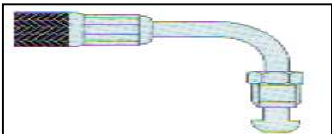

77-01-017-B	Flexible Oil Burner Hose 800mm M 1/4" X A 3/8"	£8.31 C
77-01-017-D	Flexible Oil Burner Hose 950mm M 1/4" X A 3/8" (28 Bar Rubber)	£12.80 C

77-01-459	Flexible Oil Burner Hose 265mm (high pressure) MB1 VM1 & F2 Conversion Burners	£26.06 C
-----------	--	----------



Fuel Pumps

77-01-090	12 V fuel pump	£172.12 C
77-01-091	24 V fuel pump	£182.78 C

Lift Pumps

77-07-010	BM346 3 litre	£317.24 F
77-07-010A	BM347 12 litre	£384.63 F

Galvanized Steel Bundi Tube

77-01-762	8 mm diameter soft copper per metre	£2.01 C
77-01-350-C	8 mm diameter, 1 metre length	£6.51 C

Isolation Valves



77-01-606	1/4" lever ball valve (171B02, PIPE033/B), blue	£6.66 C
77-01-607	3/8" lever ball valve (171B03, PIPE033/C), blue	£7.10 C
77-01-605	1/2" lever ball valve (171B04), blue	£7.54 C
77-01-608	8 mm isolation ball valve, yellow	£5.52 C
77-01-609	10 mm isolation ball valve, yellow	£5.51 C
77-01-610	15 mm isolation ball valve, yellow	£5.98 C

Oil Line Fitting Kits



77-01-780	1/4" x 8 mm oil line fitting kit, excluding firevalve	£32.82 C
77-01-781	1/4" x 10 mm oil line fitting kit, excluding firevalve	£34.07 C
77-01-786	1/2" x 8 mm oil line fitting kit, excluding firevalve	£33.94 C
77-01-787	1/2" x 10 mm oil line fitting kit, excluding firevalve	£35.20 C
77-01-783	3/8" x 8 mm oil line fitting kit, excluding firevalve	£32.87 C
77-01-784	3/8" x 10 mm oil line fitting kit, excluding firevalve	£34.12 C

Pressure Reducing Valve

78-01-120	GOK 10mm Pressure Reducing Valve	£35.15 C
-----------	----------------------------------	----------

Replacement Elements



77-07-005-2	Element 493 for filter 19493	£6.03 C
77-07-005-3	Element 489 for filter 19489	£4.47 C

Part No	Description	Price
---------	-------------	-------

Plastic Oil Tanks

77-01-869	Titan LP 1200 TT tank: 1200 litres, 260 gallons (length 1780 mm, width 1380 mm, height 890 mm)	£336.54 C
-----------	---	-----------

77-01-872	Titan H 1300 TT tank: 1300 litres, 285 gallons (length 1700 mm, width 1050 mm, height 1150 mm)	£414.46 C
-----------	---	-----------

77-01-873	Titan H 1800 TT tank: 1800 litres, 410 gallons (length 2055 mm, width 1130 mm, height 1145 mm)	£547.09 C
-----------	---	-----------

77-01-874	Titan H 2500 TT tank: 2500 litres, 550 gallons (length 2250 mm, width 1265 mm, height 1320 mm)	£668.12 C
-----------	---	-----------

77-01-875	Titan V 1300 TT tank: 1300 litres, 285 gallons (diameter 1190 mm, height 1400 mm)	£336.54 C
-----------	--	-----------

77-01-876	Titan FM 5000 Fuelmaster bunded tank: 5000 litres, 1100 gallons (length 31220 mm, width 2330 mm, height 2090 mm)	£5,735.74 C
-----------	---	-------------

77-01-877	Titan V 5000 TT tank: 5000 litres, 1100 gallons (diameter 2010 mm, height 2240 mm)	£1,143.73 C
-----------	---	-------------

77-01-878	Titan V 10000 TT tank: 10000 litres, 2200 gallons (diameter 2640 mm, height 2480 mm)	£2,304.18 C
-----------	---	-------------

77-01-879	Titan V 3600 TT tank: 3600 litres, 800 gallons (diameter 1840 mm, height 1750 mm)	£722.82 C
-----------	--	-----------

77-01-880	Titan ES 1225B EcoSafe bunded tank: 1225 litres, 269 gallons (length 2070 mm, width 1000 mm, height 1580 mm)	£1,007.97 C
-----------	---	-------------

77-01-881	Titan ES 1300B EcoSafe bunded tank: 1300 litres, 385 gallons (length 1900 mm, width 1220 mm, height 1330 mm)	£1,099.15 C
-----------	---	-------------

77-01-882	Titan ES 2500B EcoSafe bunded tank: 2500 litres, 550 gallons (length 2530 mm, width 1470 mm, height 1550 mm)	£1,276.54 C
-----------	---	-------------

77-01-883	Titan ES 5000B EcoSafe bunded tank: 5000 litres, 1100 gallons (diameter 2250 mm, height 2400 mm)	£2,420.50 C
-----------	---	-------------

Plastic Oil Tanks (continued)





77-01-884	Titan FM 2500 Fuelmaster bunded tank: 2500 litres, 550 gallons (length 2530 mm, width 1430 mm, height 1855 mm)	£3,002.13 C
-----------	---	-------------

77-01-890	Titan V 2500 TT tank: 2500 litres, 550 gallons (diameter 1640 mm, height 1440 mm)	£484.09 C
-----------	--	-----------

77-01-891	Titan R 1225 TT tank: 1225 litres, 270 gallons (length 1700 mm, width 720 mm, height 1400 mm)	£452.60 C
-----------	--	-----------

77-01-892	Titan FMV 5000 Fuelmaster bunded tank: 5000 litres, 1100 gallons	£5,735.18 C
-----------	--	-------------



Part No	Description	Price
15 mm Compression Fitting		
77-01-744	15 mm compression x 1/2" BSP parallel male (6671)	£1.41 C
	Deck Filler	
77-01-842	Brass deck filler (70D008)	£22.82 C
	Filler Hose	
77-01-844	1 m filler hose	£17.89 C
Fuel Tank Vent		
77-01-840	1/2" BSP brass fuel tank vent	£9.14 C
	Stop Plug	
77-01-743	1/2" square head BSPT	£1.10 C
	Tank Adaptors	
77-01-850	Adaptor for tank 3 1/2" long (TM4545)	£8.00 C
77-01-851	Adaptor for tank 6 1/4" long (TM4549)	£8.35 C
77-01-852	Adaptor for tank 7 1/4" long (TM4547)	£10.31 C
Tank Gauge Vent Bush		
77-01-860	CBV1 tank gauge vent bush	£16.31 C
Tankmaster Kit		
77-01-854	6 foot Tankmaster kit	£73.88 C
Tankmaster Filter Kit		
77-01-855	Filter kit for Tankmaster	£7.05 C
Tigerloop		
77-01-857	TL6000	£84.99 C
77-01-858	Fitting kit	£45.41 C

Part No	Description	Price
---------	-------------	-------

Marine Calorifiers: Single Coil

All are pre-lagged with 5 1/2" male + 1 21/4



77-01-640	Single coil 18" x 12" copper (23.5 litres, 5.2 gallons)	£259.59 D
77-01-642	Single coil 24" x 12" copper (34.1 litres, 7.5 gallons)	£280.83 D
77-01-644	Single coil 30" x 12" copper (44.7 litres, 9.8 gallons)	£339.39 D
77-01-646	Single coil 33" x 12" copper (50.0 litres, 11.0 gallons)	£316.90 D
77-01-648	Single coil 36" x 12" copper (55.3 litres, 12.2 gallons)	£343.90 D
77-01-650	Single coil 18" x 14" copper (31.2 litres, 6.9 gallons)	£282.23 D
77-01-652	Single coil 24" x 14" copper (45.7 litres, 10.1 gallons)	£302.54 D
77-01-654	Single coil 30" x 14" copper (60.1 litres, 12.2 gallons)	£317.08 D
77-01-656	Single coil 33" x 14" copper (67.1 litres, 14.8 gallons)	£343.06 D
77-01-658	Single coil 36" x 14" copper (74.5 litres, 16.4 gallons)	£372.25 D
77-01-660	Single coil 18" x 18" copper (48.4 litres 10.6 gallons)	£395.47 D
77-01-662	Single coil 24" x 18" copper (72.3 litres, 15.9 gallons)	£418.70 D
77-01-664	Single coil 30" x 18" copper (96.2 litres, 21.2 gallons)	£439.03 D
77-01-666	Single coil 33" x 18" copper (108 litres, 23.8 gallons)	£453.55 D
77-01-668	Single coil 36" x 18" copper (120 litres, 26.4 gallons)	£468.09 D

Marine Calorifiers: Twin Coil

All are pre-lagged with 5 1/2" male + 1 21/4



77-01-641	Twin coil 18" x 12" copper (23.5 litres, 5.2 gallons)	£288.61 D
77-01-643	Twin coil 24" x 12" copper (34.1 litres, 7.5 gallons)	£311.49 D
77-01-645	Twin coil 30" x 12" copper (44.7 litres, 9.8 gallons)	£321.44 D
77-01-647	Twin coil 33" x 12" copper (50.0 litres, 11.0 gallons)	£345.97 D
77-01-649	Twin coil 36" x 12" copper (55.3 litres, 12.2 gallons)	£372.93 D
77-01-651	Twin coil 18" x 14" copper (31.2 litres, 6.9 gallons)	£311.26 D
77-01-653	Twin coil 24" x 14" copper (45.7 litres, 10.1 gallons)	£331.59 D
77-01-655	Twin coil 30" x 14" copper (60.1 litres, 12.2 gallons)	£346.11 D
77-01-657	Twin coil 33" x 14" copper (67.1 litres, 14.8 gallons)	£378.07 D
77-01-659	Twin coil 36" x 14" copper (74.5 litres, 16.4 gallons)	£401.30 D
77-01-661	Twin coil 18" x 18" copper (48.4 litres 10.6 gallons)	£451.66 D
77-01-663	Twin coil 24" x 18" copper (72.3 litres, 15.9 gallons)	£470.86 D
77-01-665	Twin coil 30" x 18" copper (96.2 litres, 21.2 gallons)	£483.52 D
77-01-667	Twin coil 33" x 18" copper (108 litres, 23.8 gallons)	£507.56 D
77-01-669	Twin coil 36" x 18" copper (120 litres, 26.4 gallons)	£574.87 D
77-01-690	High recoverable hot water cylinder (10 gallons)	£440.07 D

Marine Calorifier Spares

77-01-693	Immersion heater	£39.16 C
77-01-694	3 bar service valve	£40.47 C
	Single check valve	TBA C
	Flexi adaptor	TBA C
	Vessel adaptor	TBA C
	High recovery coil	TBA C
77-01-695	Cylinder thermostat (operating temperature 20°C to 90°C)	£40.47 C
77-01-696	Safety / pressure relief valve (set at 3 bar / 44 PSI)	£16.19 C
77-01-697	Safety / pressure relief valve with gauge (set a 3 bar / 44 PSI)	£32.56 C



Potable Expansion Vessel For Hot Water

77-07-032	12 litre potable pressure vessel with filler loop	£91.38 C
-----------	---	----------

Non Potable Expansion Vessel For Central Heating

77-07-019	6 litre non potable expansion vessel	£39.50 C
77-07-017	12 litre non potable expansion vessel	£45.53 C
77-07-017-A	18 litre non potable expansion vessel	£50.34 C
77-07-017-B	24 litre non potable expansion vessel	£72.06 C
77-07-017-C	8 litre non potable expansion vessel	£43.59 C

Pressure System

77-07-020	6 litre non potable pressure system complete	£103.21 C
-----------	--	-----------



Pumps

Bilge

75-01-030	Rule automatic bilge Pumps 500 gallon per hour	£84.85 C
75-01-035	Rule automatic bilge Pumps 1100 gallon per hour	£133.95 C
75-01-020	Rule Electric bilge Pumps 500 gallon per hour	£35.95 C
75-01-025	Rule Electric bilge Pumps 800 gallon per hour	£43.86 C

Shower

75-01-001	Whale gulper shower & waste	£188.39 C
-----------	-----------------------------	-----------



Water Circulating Pumps

77-01-560	12 V water circulating pump	£116.33 H
77-01-561	24 V water circulating pump	£132.18 H
77-07-026	230/240 grundfoss circulating 5M pump	£54.05 H
77-07-031	230 V SP55 5m water circulating pump	£48.94 H
77-01-564	Jabsco 12V dc water circulating pump	£92.96 H
77-01-565	Jabsco 8-28V dc water circulating pump 1/2"	£120.97 H
77-01-566	Jabsco 8-28V dc water circulating pump 19mm	£120.97 H

Water Circulating Pump Accessories



77-01-543	Motor speed controller (switched mode power supply)	£30.99 C
77-01-547	3/4" hose to 15 mm copper adaptor (12 V pump)	£3.53 C
77-01-551	5/8" hose to 15 mm copper adaptor (24 V pump)	£3.53 C
77-01-545	Stainless steel hose clip for adaptor (common to both pumps)	£11.75 C
77-07-022	Auto air vents	£9.48 C

Water Circulating Pump Kits



77-01-562	12 V water circulating pump kit	£177.14 D
77-01-563	24 V water circulating pump kit	£156.80 D
	Jabsco 12V dc water circulating pump kit	D
	Jabsco 8-28V dc water circulating pump kit 1/2mm	D
	Jabsco 8-28V dc water circulating pump kit 19mm	D

Water Radiator Additives

77-07-040	Protector cartridge (fernox)	£38.68 D
77-07-041	Restorer cartridge (fernox)	£32.20 D
77-07-043	Sentinel system inhibitor x 100 1 litre	£30.02 D

Underfloor Heating

77-06-020	Underfloor heat exchangers 10kw x 20 gallon store	TBA
77-06-021	Underfloor heat exchangers 8kw x 15 gallon store	£411.24 H
77-06-022	Underfloor heat exchangers 5kw x 10 gallon store	TBA

Part No	Description	Price
<i>DC-DC Converter</i>		
77-07-024	12-24 V DC-DC converter 8A (ICO 8660)	£164.64 H
77-07-029	12V battery charger SBC-4	£28.45 H
<i>AC-DC Power Supply</i>		
87-01-905	10amp regulated (230VAC - 24VDC) (89450-241)	£195.89 H

Part No	Description	Price
---------	-------------	-------



240 V Solenoid Valves

77-01-085	Delta F84 1600 mm 1/8 x 1/8	£25.94 C
77-01-084	Brahma E7L 1/8 x 1/8 1809100	£20.27 C
77-01-047-C	Suntec	£22.64 C

Atomising Nozzles



77-01-016-J	Danfoss .3 x 60 degree H	£9.90 C
77-01-016-K	Danfoss .3 x 80 degree H	£9.90 C
77-01-016-L	Danfoss .35 x 60 degree H	£9.90 C
77-01-016-H	Danfoss .4 x 60 degree H	£7.90 C
77-01-016	Danfoss .4 x 80 degree H	£7.90 C
77-01-016-G	Danfoss .5 x 60 degree H	£7.90 C
77-01-016-A	Danfoss .5 x 80 degree H	£7.90 C
77-01-016-AC	Danfoss .55 x 80 degree H	£7.90 C
77-01-016-C	Danfoss .6 x 60 degree H	£7.90 C
77-01-016-AB	Danfoss .6 x 80 degree H	£7.90 C
77-01-016-D	Danfoss .65 x 60 degree H	£7.90 C
77-01-016-B	Danfoss .65 x 80 degree H	£7.90 C
77-01-016-E	Danfoss .75 x 60 degree H	£7.90 C
77-01-014-D	Danfoss .75 x 80 degree H	£7.90 C
77-01-016-F	Danfoss .85 x 60 degree H	£7.90 C
77-01-014-G	Danfoss 1.0 x 60 degree S	£7.90 C
77-01-016-N	Danfoss 1.65 x 80 degree H	£7.90 C

Controller Parts



77-01-066	S701 base and cable entry plate	£12.40 C
77-01-065	TFI830.2B and TFI832.3B controller top	£42.30 C
87-01-900-19	DKO 992 satronic control box top for 230/240 V PJ	£95.56 C
80-01-007	TF1852B control box 240V now replaced by (MM1810.1) mod 35	£172.04 C
77-01-064	MM1 810.1 satronic gas controller top	£109.35 C



Conversion Base

77-01-065-1	MW 880HH multi-wire	£24.39 C
77-01-066	S98 base & cable entry plate (75310 & 70503)	£12.40 C



Electrodes

77-01-009	NF 1 124330 (blue / black box burner) one off electrode	£15.63 C
77-01-441	Flexaflame burner two off electrodes	£7.05 C
77-01-026	4-317 Red female bullet connector 4mm	£0.89 C

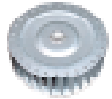

Fan

77-01-015	RH fan TLR 108 x 42 RE (12 mm shaft)	£18.69 C
77-01-015-E	RH fan TLR 108 x 42 RE (6 mm shaft)	£21.82 C



Fuel Pumps

77-01-047	R/T Suntek gear-driven rotation pump AS47A-K 7564-3	£103.47 C
77-01-472	Delta VU1 universal fuel pump (LR2)-1/4"	£102.81 C
77-01-087	Nippon VSC36H solenoid pump	£120.00 C
77-07-010	Nippon BM346 3 litre solenoid lift pump	£317.24 H
77-07-010A	Nippon BM347 12 litre solenoid lift pump	£384.63 H
77-01-081	Tiason oil pump (MP45SLR-S) (T 7 burner etc.)	£95.04 C



Ignition Transformers

80-01-005	Satronc ZT812 0.4 m	£43.53 C
77-01-355	Brahma TC2S724A / TC2STCA	£34.93 C
77-01-335-1	Satronc ZT930	£46.75 C
77-01-358	Danfoss EB1 052F0030	£49.67 C
77-01-382	Noelec 240 volt (3905100)	£56.40 C



Motors

77-01-001-AA	Burner pump motor type 1/2162 (VDE0530/84 100)	£109.83 C
77-01-001-E	Burner pump motor type 1/2158	£109.83 C
77-01-385	NOTA AVAILABLE ANY MORE SEE: 77-01-389A Stemshire 1/2" ST1248 240 V 50 Hz: reference 73038027 230-1-50 CL-F (replaced Mycalex K3-24-049 motor)	N/A C
77-01-389A	Smith Motor 230v 50HZ c/w mounting plate	£85.00 C



Motor bearings

77-01-001-B	Simel: require two per motor	£16.90 C
77-01-001-D	Stemshire: require two per motor	£16.81 C
77-01-001-D	Mycalex: require two per motor	£16.81 C



Photocells

77-01-004-A	Danfoss LD type 057H202011 48 mm cable	£17.03 C
77-01-351	Satronic MZ 7705 and MZ flange	£8.57 C



Transformer Accessories

77-01-335-A	Mains plug to suit Satronic ZT930	£5.22 C
77-01-336-A	Brahma HT leads - 2 per transformer	£4.92 C
77-01-336-B	Satronic HT leads to suit blue box burner (2 per transformer)	£7.95 C
77-01-336-C	Satronic HT leads to suit VM1, MB1 and F2 burners (2 per transformer)	£11.16 C
77-01-026	Red female bullet connectors to convert to ZT930 transformer	£0.89 C
77-01-390	EB1 service kit 052F0061 inc lead & clamps for EB1 052F0030	£19.00 C

Part No	Description	Price
Capillary Thermostats		
77-09-025	Bubble pressure jet boiler capillary thermostat 50-86 (TUA4C-004)	£15.66 C
77-01-008	Bubble pressure jet boiler capillary thermostat M/R 95C (TSLM 32-03)	£13.06 C
Oven Temperature Thermostat		
77-09-021	TUX3X-002 50-320 degrees C	£23.09 C
Room Thermostat		
77-09-024	Bubble pressure jet boiler room thermostat (TA630-01)	£31.33 C
77-07-023	Bubble pressure jet boiler frost thermostat	£18.78 C
77-01-522	Siemens programmable room stat (REV12)	£193.43 C
Water Thermostats		
77-01-007	Bubble bi-pole thermostat	£38.09 C
77-01-007-C	Bubble bi-pole thermostat assembly	£70.92 C
77-01-011	Sopac pipe thermostat SAX3X-001 clip on pipe stats (replaces SA09-01 and SA25-91) adj & fixed	£31.23 C
77-01-011-A	Cylinder/Pip stat (SAX3X003)	£28.44 C
77-01-007-A1	Bi-pole stat assy (Rayburn supreme) Oil conversion	£81.08 C
77-01-007-B	Bi-pole stat assy (S/Super star) Oil conversion	£65.27 C
77-01-007-D	Bi-pole L/Lead boxed thermostat	£67.96 C



Time Clock

Section 11



Part No	Description	Price
<i>Time Clock</i>		
77-01-520	24 V DC digital time clock	£84.60 H
77-01-523	Danfoss time clock 2 chanel fully programmable for heat & water (FP715C)	£95.13 C

Part No	Description	Price
Oil Flow Rate		
77-01-513	25 ml measuring cylinder, 0.5 ml steps	£9.66 C
77-01-514	50 ml measuring cylinder, 1.0 ml steps	£10.69 C



Vacuum and Flow Rate		
100005	Vacuum gauge	£54.18 C

Part No	Description	Price
---------	-------------	-------

Oil Control Valves



78-01-008B	Toby 3904006 DVR 4/13 4CST	£95.24 C
78-01-008E	Toby OCV 4/13 cc 1.8 5215D100H99	£91.60 C
78-01-008G	Toby OCV 4/16 4CST 3904122	£95.24 C
78-01-008H	Toby OCV 4/18 4CST 3904123	£79.41 C
78-01-024	OCI marine 252AY 4/10 4CST	£122.28 C

78-01-035	252AY 4/13 4 cst oil control valve	£92.20 C
78-01-036	252AY 4/16 4 cst oil control valve	£92.20 C
78-01-017	OCI 240VRW02 4/20 4 CST	£89.49 C
78-01-016	OCI 240VRW02 4/20 1.8 CST	£89.49 C
78-01-009	OCI 240VRW02 4/18 4 CST	£89.49 C



78-01-007	OCI 240VRW02 4/18 1.8 CST	£89.49 C
78-01-029	OCI 240VRSW02 6/27 1.8 CST	£89.49 C
78-01-018	OCI 240VRSW02 4/22 4 CST	£89.49 C
78-01-012	OCI 240VRSW02 4/22 1.8 CST	£89.49 C
78-01-028	OCI 240VRSW02 4/20 4 CST	£89.49 C
78-01-027	OCI 240VRSW02 4/20 1.8 CST	£89.49 C
78-01-026	OCI 240VRSW02 4/18 4 CST	£89.49 C
78-01-025	OCI 240VRSW02 4/18 1.8 CST	£89.49 C



78-01-021	OCI 240VR 4/8 4 CST	£64.68 C
78-01-013	OCI 240VR 4/8 1.8 CST	£64.68 C
78-01-004	OCI 240VR 4/20 4 CST	£64.68 C
78-01-011	OCI 240VR 4/20 1.8 CST	£64.68 C
78-01-023	OCI 240VR 4/18 4 CST	£64.68 C
78-01-020	OCI 240VR 4/18 1.8 CST	£64.68 C
78-01-019	OCI 240VR 4/16 4 CST	£64.68 C
78-01-014	OCI 240VR 4/16 1.8 CST	£64.68 C
78-01-022	OCI 240VR 4/13 4 CST	£64.68 C
78-01-010	OCI 240VR 4/13 1.8 CST	£64.68 C
78-01-006	OCI 240VR 3/6 4 CST	£64.68 C
78-01-003	OCI 240VR 3/6 1.8 CST	£64.68 C



Controls for Oil Valves

78-01-008C	Toby aquastat (to suit 78-01-008B)	£90.50 C
78-01-008D	Toby phial pocket to suit aquastat	£12.07 C



Lighting Bung For Use With Fire Lighter

87-01-501LWA	Lighting bung to suit Bubble B1-5 to B2-3/5	£26.38 C
87-01-700LWA	Lighting bung to suit Bubble B2-9/2 to B3-17/3 10kW	£26.38 C

Pot Burners



78-01-001	6 Aga vap pot also Awena pot burner 3904080	£119.94 C
78-01-170	5 kW Socomef 7" blue flame burner including ring and catalyser	£104.34 C
78-01-171	10 kW Socomef 8" blue flame burner including ring and catalyser	£108.18 C
78-01-172	15 kW Socomef 10" blue flame burner including ring and catalyser	£111.34 C
905317-B	Bubble 8 kW pot	£102.15 C
905356-B	Bubble 10 kW pot	£99.67 C
87-01-600PA	Bubble 2 dry / small boiler pot assembly	£195.37 C
87-01-600PA2	Bubble 2 large boiler pot assembly	£195.37 C

Pot burner Set Up

78-01-160	7 kW includs oil control valve & descaler	£184.21 C
78-01-150	10 kW includs oil control valve & descaler	£191.21 C

Pot burner Spares



78-01-173	Socomef catalyser to suit 7" blue flame burner (corner oil) & Aga vap	£27.91 C
78-01-174	Socomef catalyser to suit 8" & 10" blue flame burner	£34.15 C
78-01-176	Socomef flame ring to suit 7" blue flame burner (corner oil)	£17.00 C
78-01-177	Socomef flame ring to suit 8" blue flame burner	£18.00 C
78-01-178	Socomef flame ring to suit 10" blue flame burner	£20.37 C
78-01-001-A	Aga vap cast ring & also awena pot ring	£11.28 C
119216-B	Bubble descaling device to suit all burners	£24.42 C
78-01-100	Socomef descaling device to suit all burners	£15.21 C
78-01-101	Socomet packig gland for descaling device PTFE seal	£2.47 C
194401-B	Bubble upper catalyser	£29.58 C
	(for Rayburn Royal, Regent, MF or Supreme)	
198205-B	Bubble catalyser ring for Rayburn Royal, Regent, MF or Supreme	£10.13 C
194402-B	Bubble catalyser body for Rayburn Royal, Regent, MF or Supreme	£29.77 C
78-01-110	Bubble cleaning tool for small pot (B1 and B2 up to 3/5 kW)	£12.82 C
78-01-112	Bubble cleaning tool for small pot (B2 9/2, B21 and B3 twin pot)	£12.82 C



Thermal Relays / Flex-a-Temp

78-01-015	OCI flexatemp 230 vac (4503-012V)	£60.82 C
165652-B	including microswitch (4509-020V)	£66.64 C
78-01-015-1	OCI flexatemp12 vdc aga type	£55.01 C



Thermal Relay Elements

78-01-042	240 V	£11.10 C
78-01-040	12 V	£11.10 C

Wick

77-01-925	Bubble wick 1/2"	£2.35 C
77-01-926	Aga wick 1 m	£11.16 C

E&OE