

STOVAX
Fire Your Imagination

Professional XQ™

Stove & Fireplace
Chimney Systems



Welcome to Stovax

Stovax is a UK based company dedicated to the development of high quality stoves, fireplaces, flue systems and associated accessories. Stovax has grown over 38 years to become one of Europe's largest and most respected stove and fireplace manufacturers, constantly building on a reputation for superior craftsmanship, high quality materials, designer-led aesthetics and technical innovation.



The Stovax Group's prestigious product portfolio includes everything from the traditional to the ultra-contemporary in a wide array of styles and sizes, so whether your choice is solid fuel or gas, you can be sure to find a stove or fireplace from our range to add the perfect warmth and character to your home. Full details of Stovax's complete range of products can be found at www.stovax.com.

The Stovax Professional XQ™ range is a comprehensive programme of twin wall flue pipe components alongside our vitreous enamel single wall flue pipe, ensuring there is everything you need to create your own complete flue system. Professional XQ™ offers unique benefits to both home owners and installers alike, and with a high level of customer service and support to match, making Stovax the natural choice for your professional chimney system, whether it is for a Stovax appliance or an alternative!

Expert Retailer Network

We take great care to ensure that our stoves, fireplaces, flue systems and associated accessories are designed, tested and manufactured to the highest possible quality and safety standards. We are just as concerned to make certain that they are sold and installed correctly so that you enjoy years of pleasure from your purchase.

Accordingly, you will find that our products are only available from experienced, independent retailers who will be happy to show you a selection of models locally in their showrooms, often fully operational. These independent retailers will discuss your individual requirements both technical (such as sizing the heat output to your room and advising on your flue type) and design, and ensure that you select the most appropriate product for your home.

They will also be able to advise on or assist with the installation process as well as help provide any after-sales support and servicing your appliance may require in the future.

Whilst we encourage our retailers to promote fireplace products and their outlets via the internet, we do not believe suitable levels of customer care and satisfaction can be obtained from nationwide online sales and we would strongly recommend that you consider this when undertaking your research and making a purchasing decision. Furthermore, please be aware that we do not offer technical support (beyond our statutory responsibilities) to products bought via nationwide online sales, where this support would normally be offered by one of our qualified, independent retailers.



10 Year Extended Warranty

For complete peace of mind, the Stovax Professional XQ™ range carries up to 10 years of warranty. For further details please refer to page 30.

Image: Stovax Vogue Medium

10
YEAR
EXTENDED
WARRANTY

Professional XQ™ Stove & Fireplace Chimney Systems

Incorporating 6 flue diameters from 125mm - 300mm, along with a complete range of fixings and accessories, Professional XQ™ can be configured to suit virtually any installation requirement. The chimney system offers not only water tight protection for the insulation within, but also protection during handling from cuts and abrasions that can be caused by normally sharp flue edges. The Professional XQ™ range with Twist-Lock connection, allows for quicker, easier and safer installation, with more versatility than other leading brands.

Key Features

- Easy to install Twist-Lock system
- Weatherproof components
- Suitable for internal & external applications
- High density insulation
- Made from high grade stainless steel
 - 316L stainless steel inner wall for the highest corrosion resistance
 - 304L stainless steel outer wall in an attractive, polished finish
- Innovative decorative components
- All components are available in a wide range of colours

Range of Colour Options

With over 450 colour choices all external components in the Professional XQ™ range can be powder coated to virtually any colour of your choice.* This enables you to match any requirements that may have been set by local planning authorities or to any specific aesthetic requirements you may have of your own. We also offer heat resistant textured matt black finish, strictly for internal use only which can be installed right down to your stove or fireplace.



* Can be colour matched to any RAL colour. Please note: the textured Matt Black powder finish is suitable for internal applications only. It has a rated heat resistance up to 500°C and can safely be used right down to the stove. RAL colours used on external applications are rated up to 200°C and are therefore not suitable for use near the stove.

XQ FlueDesigner™ App (for Specifiers)

Stovax has developed an easy to use app that can generate a specification and drawing for your Professional XQ™ installation on iOS and Android mobile devices. Exclusively designed for use by Stovax's network of independent retailers and specifiers, this handy tool provides a drawing, component list, quotation and more based upon the information provided about the installation. For further details, please see page 25.



Stovax Elise 540T Cassette Fire with Edge+ frame

Quality Assured

The Professional XQ™ range is tested, approved and CE Marked to BS EN 1856-1: 2009 as required under the Construction Products Regulation and administered by BSI with the following designation:

BS EN 1856-1 T450 N1 D Vm L50050 G50

Tested and approved under all the requirements of BS EN 1856-1:2009 including clause NA.5; compliance with all the relevant fire rating requirements for stability and integrity under BS476-20:1987, and the general requirements of BS EN 1443:2003 for chimneys.

Stovax Professional XQ™ has HETAS Approval.

All twin wall components are made from 0.5mm thick, high grade stainless steel and are corrosion and sootfire resistant, with a minimum distance to combustible materials of 50mm.

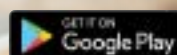

INTERNAL INSTALLATION

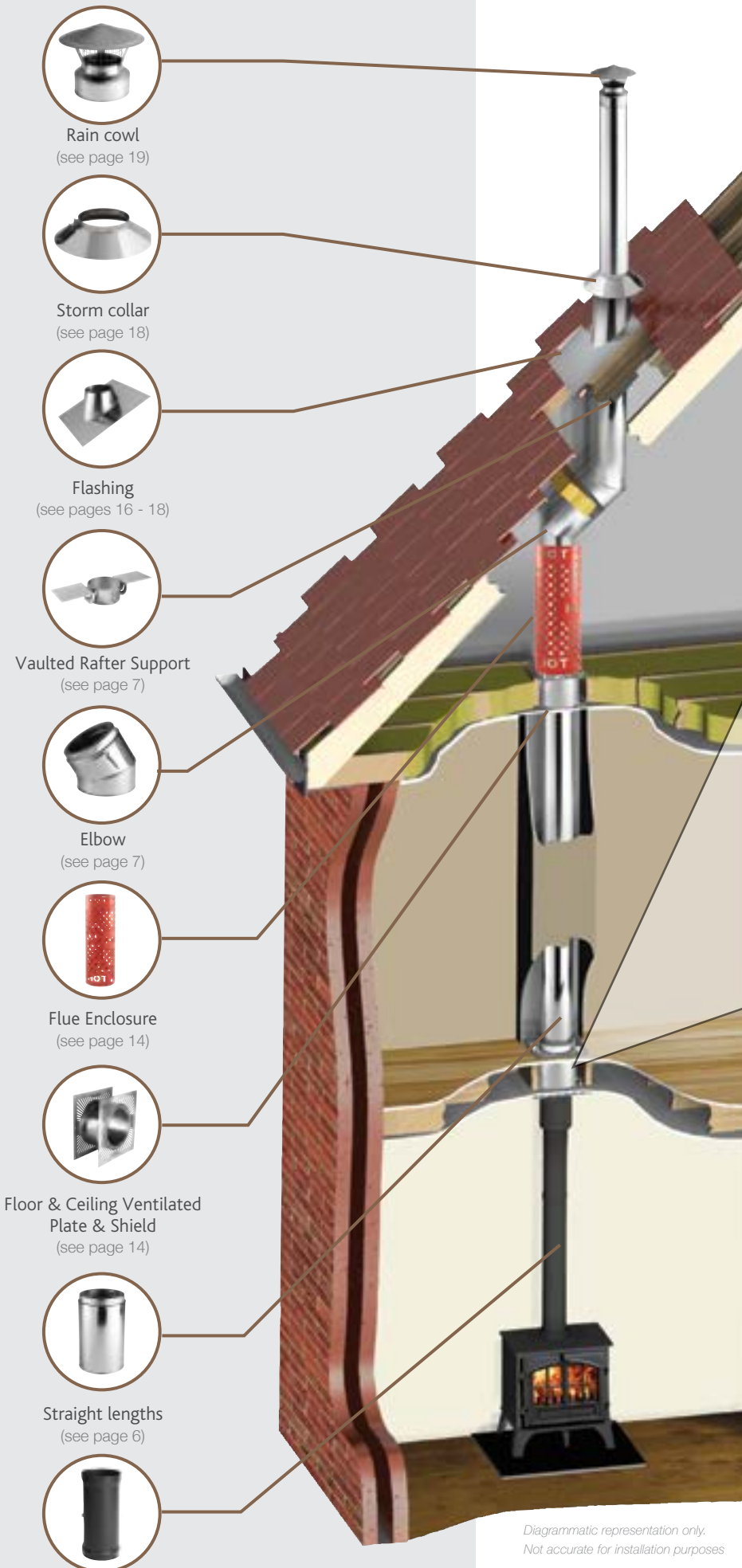

Rain cowl
(see page 19)



Storm collar
(see page 18)

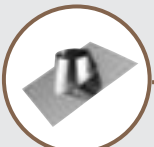

Flashing
(see pages 16 - 18)



Vaulted Rafter Support
(see page 7)



Elbow
(see page 7)



Flue Enclosure
(see page 14)

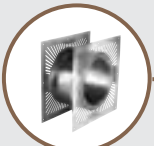

Floor & Ceiling Ventilated
Plate & Shield
(see page 14)



Straight lengths
(see page 6)



Enamelled flue pipe
(see pages 20 - 22)

Stovax offers 4 standard powder coating colours. For internal twin wall components, Textured Matt Black; and for external components, Satin Black, Gloss Black and Satin White. However, all external parts can be powder coated to any colour in the RAL range. For example:



RAL is a European colour matching system mainly used for paint and powder coating.

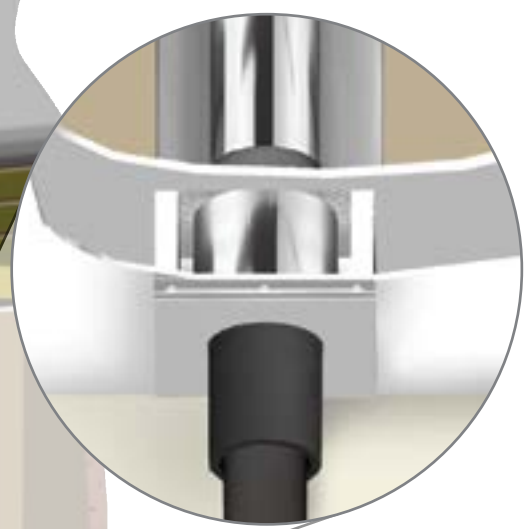

Innovative Decorative Solutions



Decorative single to twin adaptor

This component allows a cut length of vitreous flue pipe to be inserted up to 90mm into a twin wall system to give a completely seamless join (see page 10).

Decorative ceiling cover plate

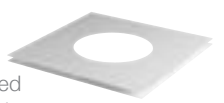

This component is supplied powder coated white to give a perfect finish to the system when passing through a ceiling. Secured by magnets, it is designed to fit beneath floor and ceiling vented and non-vented shields, showing no visible fixings (see page 15).

*Diagrammatic representation only.
Not accurate for installation purposes*

THROUGH WALL INSTALLATION

Straight enamelled flue pipe, elbows and Tee-pieces are available in the two colour options below.



Matt Black



Ivory



Innovative Technical Solutions

Extendable Wall bracket

Allowing an adjustment of 50 – 80mm from the wall, the bracket's outer facing flange and captive nuts facilitate a straight forward and quick installation. (see page 11)



Captive Nuts

Where relevant, Professional XQ components feature captive nuts. These offer easier single-handed installation and contribute to increased installer safety whilst working at height.

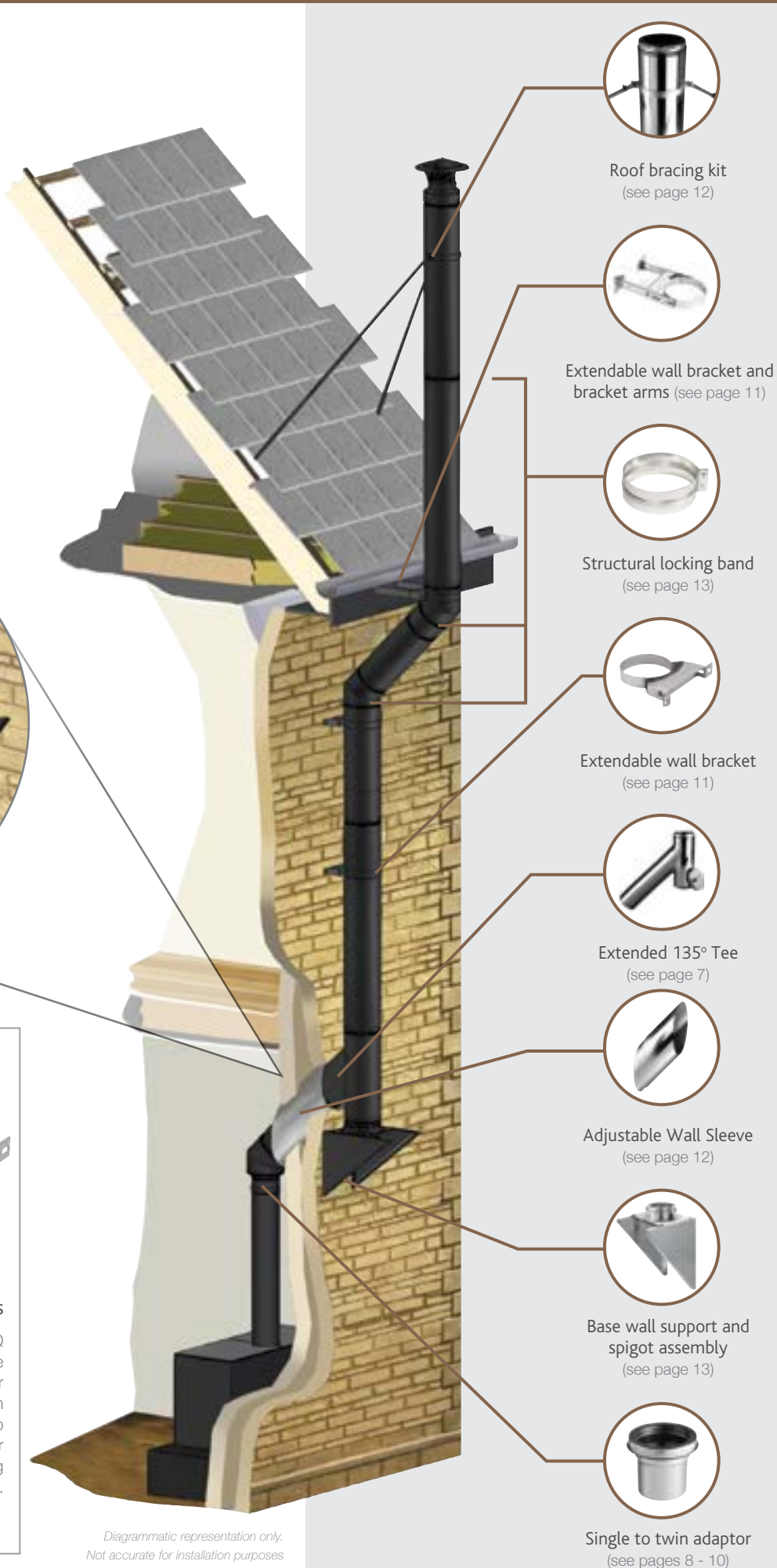

Roof bracing kit
(see page 12)



Extendable wall bracket and
bracket arms (see page 11)



Structural locking band
(see page 13)



Extendable wall bracket
(see page 11)



Extended 135° Tee
(see page 7)

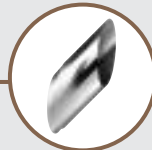

Adjustable Wall Sleeve
(see page 12)

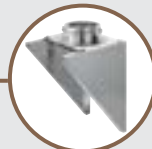

Base wall support and
spigot assembly
(see page 13)



Single to twin adaptor
(see pages 8 - 10)

*Diagrammatic representation only.
Not accurate for installation purposes*

STRAIGHT PIPES

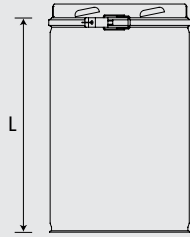

Straight lengths

Available in 6 lengths which can be easily combined to achieve the required height for the installation. Each joint is firmly secured with our Twist-Lock system and included locking band. All lengths must be installed with the male socket pointing upwards. Outside diameter is 50.5mm greater than the inside diameter.

Nominal Length	1200mm	1000mm	750mm
Effective Length (L)	1200mm	1000mm	750mm
Ø125mm	FXQ125-001	FXQ125-002	FXQ125-008
Ø150mm	FXQ150-001	FXQ150-002	FXQ150-008
Ø175mm	FXQ175-001	FXQ175-002	FXQ175-008
Ø200mm	FXQ200-001	FXQ200-002	FXQ200-008
Ø250mm	FXQ250-001	FXQ250-002	FXQ250-008
Ø300mm	FXQ300-001	FXQ300-002	FXQ300-008

Length	500mm	300mm	120mm
Effective Length (L)	500mm	300mm	120mm
Ø125mm	FXQ125-003	FXQ125-004	FXQ125-005
Ø150mm	FXQ150-003	FXQ150-004	FXQ150-005
Ø175mm	FXQ175-003	FXQ175-004	FXQ175-005
Ø200mm	FXQ200-003	FXQ200-004	FXQ200-005
Ø250mm	FXQ250-003	FXQ250-004	FXQ250-005
Ø300mm	FXQ300-003	FXQ300-004	FXQ300-005

Adjustable lengths

To ease installation, these are adjustable to allow for any variation in length as specified below. Extra insulation is also included so that the additional length can be filled. Locking band included.

	340 - 500mm Adjustable length	400 - 700mm Adjustable length	540 - 900mm Adjustable length
Ø125mm	FXQ125-006	FXQ125-009	FXQ125-007
Ø150mm	FXQ150-006	FXQ150-009	FXQ150-007
Ø175mm	FXQ175-006	FXQ175-009	FXQ175-007
Ø200mm	FXQ200-006	FXQ200-009	FXQ200-007
Ø250mm	FXQ250-006	FXQ250-009	FXQ250-007
Ø300mm	FXQ300-006	FXQ300-009	FXQ300-007

Inspection lengths

Featuring a flush door this 500mm length allows for easy inspection or access for sweeping.

		L
Ø125mm	FXQ125-003INS	500mm
Ø150mm	FXQ150-003INS	500mm

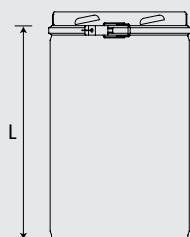
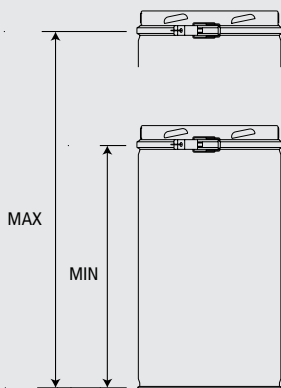

Elbows

The female elbow sockets are provided without locking tabs to enable them to be easily rotated to achieve the required direction for installation. Micro toggle locking band included.

When elbows are used externally, structural locking bands (FXQXXX-056) should be used.

	15° Elbow		30° Elbow		45° Elbow	
	FXQ ___-010		FXQ ___-011		FXQ ___-012	
	A	B	A	B	A	B
Ø125mm	58mm	83mm	67mm	92mm	76mm	101mm
Ø150mm	60mm	85mm	70mm	95mm	81mm	106mm
Ø175mm	61mm	86mm	74mm	99mm	86mm	111mm
Ø200mm	64mm	89mm	77mm	102mm	91mm	116mm
Ø250mm	66mm	91mm	84mm	109mm	101mm	126mm
Ø300mm	70mm	95mm	90mm	115mm	112mm	137mm

*Insert diameter of pipe in space provided (___) to order correct elbow.
Example: For Ø175mm, 30° elbow: order FXQ175-011

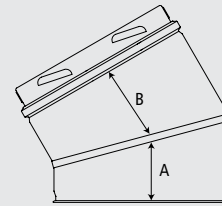

90° Tee

including Tee cap & extra locking band

This piece will allow you to make a horizontal connection. The 90° Tee is also available with an insulated Tee cap.

		ØA	B	C	L
Ø125mm	FXQ125-013	125mm	225mm	137.5mm	350mm
Ø150mm	FXQ150-013	150mm	250mm	150mm	350mm
Ø175mm	FXQ175-013	175mm	275mm	162.5mm	400mm
Ø200mm	FXQ200-013	200mm	300mm	175mm	400mm
Ø250mm	FXQ250-013	250mm	350mm	200mm	455mm
Ø300mm	FXQ300-013	300mm	400mm	225mm	510mm

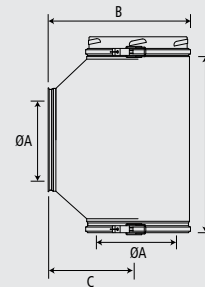

135° Tee

including Tee cap & extra locking band

A standard Tee cap is included, however for condensation drainage, a Tee cap with a drain is also available (see page 8). This can also provide an access point for inspection and cleaning.

		ØA	B	L	W
Ø125mm	FXQ125-014	125mm	300mm	500mm	387mm
Ø150mm	FXQ150-014	150mm	300mm	500mm	412mm
Ø175mm	FXQ175-014	175mm	300mm	500mm	437mm
Ø200mm	FXQ200-014	200mm	300mm	500mm	462mm
Ø250mm	FXQ250-014	250mm	350mm	600mm	547mm
Ø300mm	FXQ300-014	300mm	400mm	650mm	633mm

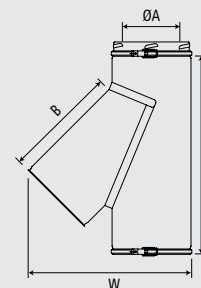

Extended 135° Tee

including Tee cap & extra locking band

The Extended 135° Tee has a 780mm through wall section which offers a joint free connection.

A standard Tee cap is included, however for condensation drainage, a Tee cap with a drain is also available (see page 8).

		ØA	B	L
Ø125mm	FXQ125-014EXT	125mm	750mm	500mm
Ø150mm	FXQ150-014EXT	150mm	750mm	500mm

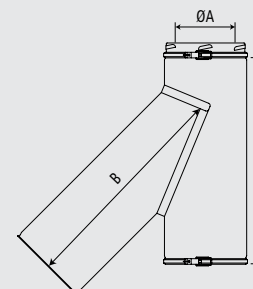

TEE CAPS & FLUE DRAUGHT STABILISER



Tee cap



Tee cap with drain



Tee Cap / Tee Cap with drain

Provides access to the system for inspection and cleaning. Included with both standard and extended tee's. The Tee Cap with drain provides access to the system, condensation drainage, inspection and cleaning. Includes locking band.

	Tee Cap	Tee Cap with drain
Ø125mm	FXQ125-015	FXQ125-016
Ø150mm	FXQ150-015	FXQ150-016
Ø175mm	FXQ175-015	FXQ175-016
Ø200mm	FXQ200-015	FXQ200-016
Ø250mm	FXQ250-015	FXQ250-016
Ø300mm	FXQ300-015	FXQ300-016

Flue draught stabiliser

Ideal for longer chimney runs where there can be a more excessive draw. This component is also useful for biomass installations where the draw can require a finer level of adjustment.

Ø125mm	FXQ125-019
Ø150mm	FXQ150-019
Ø175mm	FXQ175-019
Ø200mm	FXQ200-019

STARTER COMPONENTS/ADAPTORS

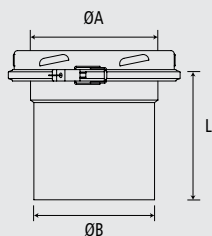

Single to twin adaptor

Use this adaptor to join single wall, Enamelled flue pipe to your twin wall system. Both the single and twin wall flue pipe must be of the same diameter to use this product. This part is secured using the Twist-Lock system and included locking band. **This adaptor should not be installed directly in to an appliance.**

		ØA	ØB	L
Ø125mm	FXQ125-020	125mm	119mm	150mm
Ø150mm	FXQ150-020	150mm	144mm	150mm
Ø175mm	FXQ175-020	175mm	172mm	150mm
Ø200mm	FXQ200-020	200mm	194mm	150mm
Ø250mm	FXQ250-020	250mm	248mm	150mm
Ø300mm	FXQ300-020	300mm	298mm	150mm

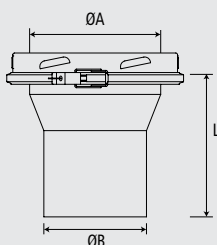

Single to twin increaser

This allows you to join a 125mm, 150mm or 175mm single wall, Enamelled flue pipe to a larger 150mm, 175mm or 200mm twin wall application. This part is secured using the Twist-Lock system and included locking band. **This should not be installed directly in to the appliance.**

		ØA	ØB	L
Ø150mm	FXQ150-021	150mm	119mm	162mm
Ø175mm	FXQ175-021	175mm	144mm	162mm
Ø200mm	FXQ200-021	200mm	172mm	162mm

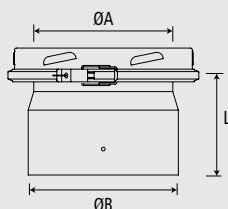

Flexible liner to twin adaptor

The design of this component allows a cut length of flexible liner to be hidden within the adaptor and then secured with self tapping screws. This product provides you with a male socket and is secured using the Twist-Lock system and included locking band.

		ØA	ØB	L
Ø125mm	FXQ125-022	125mm	137mm	100mm
Ø150mm	FXQ150-022	150mm	162mm	100mm
Ø175mm	FXQ175-022	175mm	187mm	100mm
Ø200mm	FXQ200-022	200mm	212mm	100mm

STARTER COMPONENTS/ADAPTORS

Flexible liner to twin adaptor

including anchor plate

This adaptor features all the benefits of the above Flexible liner to twin adaptor with the addition of an anchor plate which can act as a load bearing support for the system.

		ØA	ØB	C	L
Ø125mm	FXQ125-022AP	125mm	140mm	350mm	160mm
Ø150mm	FXQ150-022AP	150mm	167mm	350mm	160mm
Ø175mm	FXQ175-022AP	171mm	194mm	400mm	160mm

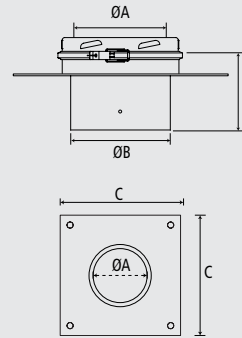

Twin to flexible liner adaptor

The design of this component allows a cut length of flexible liner to be hidden within the adaptor and then secured with self tapping screws. This product provides you with a female socket and therefore does not include a locking band.

		ØA	ØB	L
Ø125mm	FXQ125-023	137mm	125mm	130mm
Ø150mm	FXQ150-023	162mm	150mm	130mm
Ø175mm	FXQ175-023	187mm	175mm	130mm
Ø200mm	FXQ200-023	212mm	200mm	130mm

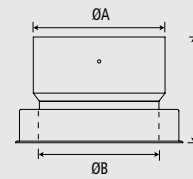

Twin to flexible liner adaptor

including anchor plate

This adaptor features all the benefits of the Twin to Flexible liner adaptor with the addition of a 40mm flange which provides a suitable seal and anchorage to a masonry chimney whilst connecting to a flexible liner.

		ØA	ØB	ØC	L
Ø125mm	FXQ125-023AP	137mm	125mm	265mm	130mm
Ø150mm	FXQ150-023AP	162mm	150mm	290mm	130mm
Ø175mm	FXQ175-023AP	187mm	175mm	315mm	130mm
Ø200mm	FXQ200-023AP	212mm	200mm	340mm	130mm

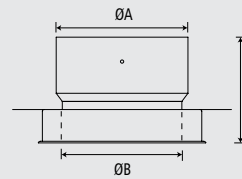

Rear flue exit kit

Comprises of a 400mm straight starter length made from 1mm steel, an adjustable wall sleeve and 90 degree tee. The starter length allows you to fit directly in to the back of the appliance with out having to add an adapter*

Use of rear horizontal flue greater than 150mm in length requires verification by calculation, this service is offered by Stovax. For further details please contact the Professional XQ™ Customer Service team.

		ØA	B	C	L
Ø150mm	FXQ150-017	150mm	350mm	50mm	500mm

* Please note if the stove has a 125mm spigot then an FXQ150-018 will also be required (see below).

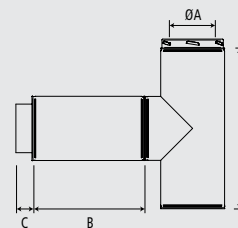

Wall flue adaptor

This vitreous enamel adaptor is designed to be used in conjunction with the rear flue exit kit when the stove has a 125mm spigot.

		ØA	ØB	L
Ø125mm	FXQ150-018	155mm	124mm	65mm

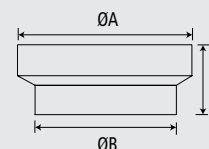

STARTER COMPONENTS/ADAPTORS

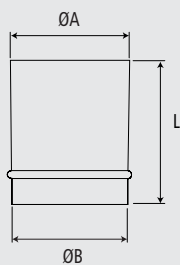

Starter piece adaptor

This vitreous enamel adaptor facilitates connecting our FXQ twin wall flue pipe directly to a stove spigot. Designed to be used in conjunction with the decorative adaptors and increasers shown below. Suitable for 125mm up to 200mm systems.

		ØA	ØB	L
Ø125mm	FXQ125-061	125mm	123mm	150mm
Ø150mm	FXQ150-061	150mm	147mm	150mm
Ø175mm	FXQ175-061	175mm	172mm	150mm
Ø200mm	FXQ200-061	200mm	197mm	150mm



Stainless Steel

Matt Black

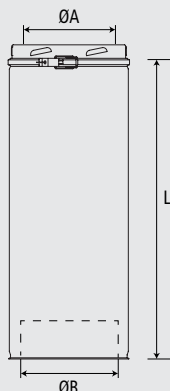

The black powder coat finish is fully heat resistant up to 500°C and can be installed right down to the stove or fire.

Decorative single to twin adaptor

For joining single wall, Enamelled flue pipe to a twin wall system of the same diameter. Inserted up to 90mm to give a completely seamless joint. Locking band included.

500mm Length

		Colour	ØA	ØB	L
Ø125mm	FXQ125-025	Stainless Steel	125mm	119mm	500mm
Ø125mm	FXQ125-025BK	Matt Black	125mm	119mm	500mm
Ø150mm	FXQ150-025	Stainless Steel	150mm	144mm	500mm
Ø150mm	FXQ150-025BK	Matt Black	150mm	144mm	500mm
Ø175mm	FXQ175-025	Stainless Steel	175mm	172mm	500mm
Ø175mm	FXQ175-025BK	Matt Black	175mm	172mm	500mm
Ø200mm	FXQ200-025	Stainless Steel	200mm	194mm	500mm
Ø200mm	FXQ200-025BK	Matt Black	200mm	194mm	500mm

975mm Length

Ø125mm	FXQ125-055	Stainless Steel	125mm	119mm	975mm
Ø125mm	FXQ125-055BK	Matt Black	125mm	119mm	975mm
Ø150mm	FXQ150-055	Stainless Steel	150mm	144mm	975mm
Ø150mm	FXQ150-055BK	Matt Black	150mm	144mm	975mm
Ø175mm	FXQ175-055	Stainless Steel	175mm	172mm	975mm
Ø175mm	FXQ175-055BK	Matt Black	175mm	172mm	975mm
Ø200mm	FXQ200-055	Stainless Steel	200mm	194mm	975mm
Ø200mm	FXQ200-055BK	Matt Black	200mm	194mm	975mm



Stainless Steel

Matt Black

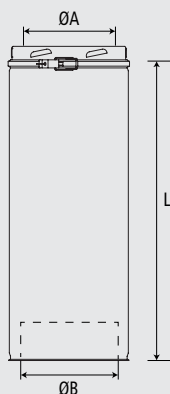

The black powder coat finish is fully heat resistant up to 500°C and can be installed right down to the stove or fire.

Decorative single to twin increaser

Allows you to join a 125mm single wall Enamelled flue pipe to a larger 150mm twin wall system. Inserted up to 90mm to give a completely seamless joint. Locking band included.

500mm Length

		Colour	ØA	ØB	L
Ø150mm	FXQ150-024	Stainless Steel	150mm	119mm	500mm
Ø150mm	FXQ150-024BK	Matt Black	150mm	119mm	500mm

975mm Length

Ø150mm	FXQ150-060	Stainless Steel	150mm	119mm	975mm
Ø150mm	FXQ150-060BK	Matt Black	150mm	119mm	975mm

Wall bracket

The wall bracket provides a lateral support at a distance of 50mm from the wall.

		ØA
Ø125mm	FXQ125-030	173mm
Ø150mm	FXQ150-030	198mm
Ø175mm	FXQ175-030	223mm
Ø200mm	FXQ200-030	248mm
Ø250mm	FXQ250-030	298mm
Ø300mm	FXQ300-030	348mm

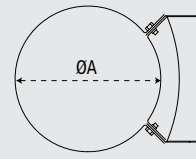

Wall bracket with easy fit extension

Allowing an adjustment of 50 - 80 mm from the wall, the bracket's outer facing flange and captive nuts facilitate a straight forward and quick installation. Suitable for providing lateral support only.

		ØA	B
Ø125mm	FXQ125-030EXT	173mm	158mm
Ø150mm	FXQ150-030EXT	198mm	182mm
Ø175mm	FXQ175-030EXT	223mm	208mm
Ø200mm	FXQ200-030EXT	248mm	233mm
Ø250mm	FXQ250-030EXT	298mm	282mm
Ø300mm	FXQ300-030EXT	348mm	332mm

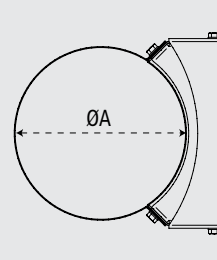

Long adjustable bracket arms

Supplied as a pair, the long adjustable bracket arms can be paired with the wall bracket to allow distance from the wall to be adjusted between 50mm - 'A' mm (see table below). Please note these arms are universal and can be used in conjunction with any size adjustable wall bracket.

		A	B (number of slots)
	FXQ125-037	227mm	4
	FXQ150-037	288mm	5
	FXQ175-037	349mm	6
	FXQ200-037	410mm	7
	FXQ250-037	471mm	8
	FXQ300-037	532mm	9

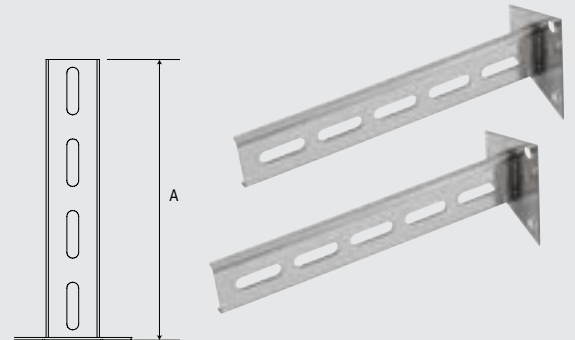

Vaulted Rafter Support

This can be fixed to roof joists to give added support to the system. On 125mm & 150mm diameters, this can support up to 6m below and 3m above the roof support, when fitted with a roof bracing kit (page 12), or 2m above the vaulted rafter support without a roof bracing kit. For details on 175mm diameters and above please see the installation instructions.

		ØA	L
Ø125mm	FXQ125-032	173mm	605mm
Ø150mm	FXQ150-032	198mm	630mm
Ø175mm	FXQ175-032	223mm	655mm
Ø200mm	FXQ200-032	248mm	680mm
Ø250mm	FXQ250-032	296mm	730mm
Ø300mm	FXQ300-032	348mm	780mm

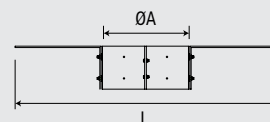

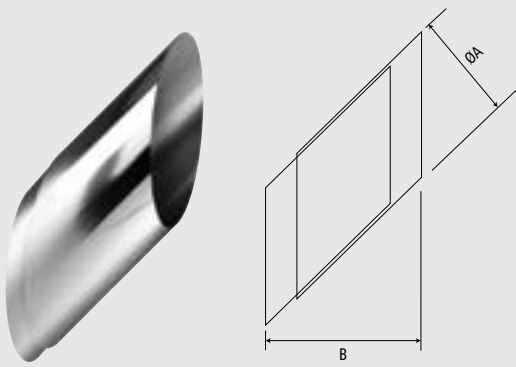

Adjustable wall sleeve

This is 50mm larger than the external diameter of the pipe and provides protection for the installation when passing through a non-combustible wall. There is no need to cut this sleeve to fit as its length can be easily adjusted and secured using self tapping screws and then taped.

		ØA	B
Ø125mm	FXQ125-033	225mm	200mm - 380mm
Ø150mm	FXQ150-033	250mm	200mm - 380mm
Ø175mm	FXQ175-033	275mm	200mm - 380mm
Ø200mm	FXQ200-033	300mm	200mm - 380mm
Ø250mm	FXQ250-033	350mm	200mm - 380mm
Ø300mm	FXQ300-033	400mm	200mm - 380mm

ØA measurements are approximate.



Roof bracing kit

This is required to support flue lengths above 2m on 125mm and 150mm diameters or 1.5m on other diameters. This is subject to specific design installation, please consult the appropriate instructions. Structural locking bands should also be used where applicable

		A
Ø125mm	FXQ125-036	1650mm - 2900mm
Ø150mm	FXQ150-036	1650mm - 2900mm
Ø175mm	FXQ175-036	1650mm - 2900mm
Ø200mm	FXQ200-036	1650mm - 2900mm
Ø250mm	FXQ250-036	1650mm - 2900mm
Ø300mm	FXQ300-036	1650mm - 2900mm

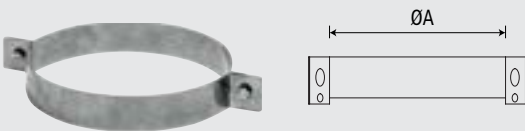

Roof Bracing Kit Band (Clamping Rings only)

		ØA
Ø125mm	FXQ125-036BND	175mm
Ø150mm	FXQ150-036BND	199mm
Ø175mm	FXQ175-036BND	225mm
Ø200mm	FXQ200-036BND	250mm
Ø250mm	FXQ250-036BND	300mm
Ø300mm	FXQ300-036BND	350mm

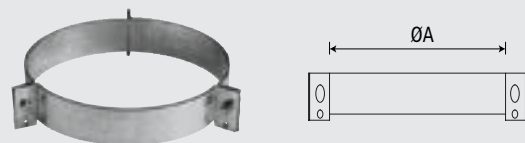

Support bracket

Can be used in 3 different ways: (1) On the wall support plate & brackets (page 13) as an intermediate support. (2) As an internal support bracket with the ventilated or non-ventilated plate and shield. (3) As a guy wire support using the 3 pre-drilled holes.

		ØA
Ø125mm	FXQ125-029	173mm
Ø150mm	FXQ150-029	198mm
Ø175mm	FXQ175-029	223mm
Ø200mm	FXQ200-029	248mm
Ø250mm	FXQ250-029	296mm
Ø300mm	FXQ300-029	348mm

Guy wire kit

Designed to be an alternative to the roof bracing kit (above) which offers a maximum span of 2.6m. the guy wire kit can reach in excess of 3m from the flue support to offer greater installation flexibility. The kit comprises 6 eyelets, 3 lengths of wire, 3 tensioning brackets, anchor clips and other components to facilitate installation of this kit. Please note a Support Bracket (above) is also required.

Ø125mm	FXQ125-039
Ø150mm	FXQ150-039
Ø175mm	FXQ175-039
Ø200mm	FXQ200-039
Ø250mm	FXQ250-039
Ø300mm	FXQ300-039

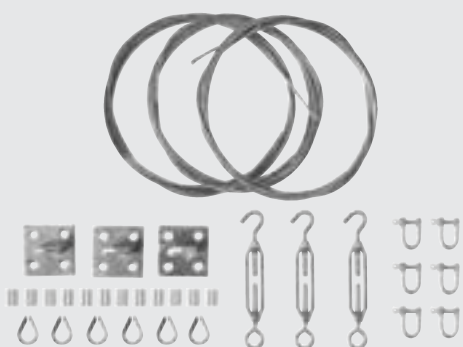

Locking bands & structural locking bands

The locking band has a simple spring connection system and is supplied with every component that has a male socket. Structural locking bands can be used to replace standard locking bands throughout the system. They are required for added support for lengths of flue in excess of 3 meters long, however where above roof level additional bracing may be required. They should also be used with elbows to provide extra support when used around the eaves of a property.

	Locking Band	Structural Locking Band
Ø125mm	FXQ125-026	FXQ125-056
Ø150mm	FXQ150-026	FXQ150-056
Ø175mm	FXQ175-026	FXQ175-056
Ø200mm	FXQ200-026	FXQ200-056
Ø250mm	FXQ250-026	FXQ250-056
Ø300mm	FXQ300-026	FXQ300-056

Base & intermediate wall support plate & brackets

Generally used for external applications. When used with the base socket/spigot plate (below) this acts as a base support for the system. With the addition of the support bracket (below) this can also provide an intermediate support anywhere along the length of the system. A Base Wall Support and Spigot assembly is also available for support with a 135° Tee.

	Triangular Brackets (x2)	Support Plate	A	B	C	D	E
Ø125mm	FXQ125-027BB	FXQ125-027PL	225	280	455	580	360
Ø150mm	FXQ150-027BB	FXQ150-027PL	250	305	455	580	360
Ø175mm	FXQ175-027BB	FXQ175-027PL	275	330	455	580	360
Ø200mm	FXQ200-027BB	FXQ200-027PL	300	355	455	580	360
Ø250mm	FXQ250-027BB	FXQ250-027PL	350	405	555	721	460
Ø300mm	FXQ300-027BB	FXQ300-027PL	400	455	555	721	460

	Support Assembly	Support & Spigot Assembly	A	B	C	D	E
Ø125mm	FXQ125-027	FXQ125-027S	225	280	455	580	360
Ø150mm	FXQ150-027	FXQ150-027S	250	305	455	580	360
Ø175mm	FXQ175-027	FXQ175-027S	275	330	455	580	360
Ø200mm	FXQ200-027	FXQ200-027S	300	355	455	580	360
Ø250mm	FXQ250-027	FXQ250-027S	350	405	555	721	460
Ø300mm	FXQ300-027	FXQ300-027S	400	455	555	721	460

All above dimensions are in mm

Base socket/spigot plate

including fixings

Used with a wall support plate (see above) to provide a secure, locking base for the installation. Includes locking band.

		ØA	ØB	L
Ø125mm	FXQ125-028	125mm	225mm	72mm
Ø150mm	FXQ150-028	150mm	250mm	72mm
Ø175mm	FXQ175-028	175mm	275mm	72mm
Ø200mm	FXQ200-028	200mm	300mm	72mm
Ø250mm	FXQ250-028	250mm	350mm	72mm
Ø300mm	FXQ300-028	300mm	400mm	72mm



Locking Band



Structural Locking Band



Triangular Brackets



Support Plate

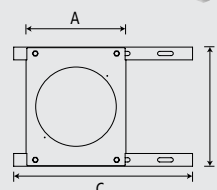

Support Assembly

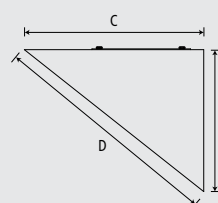

Support & Spigot Assembly

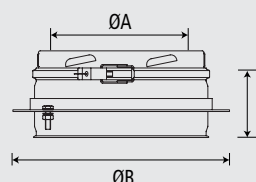

FLOOR & CEILING FIRESTOP PLATES

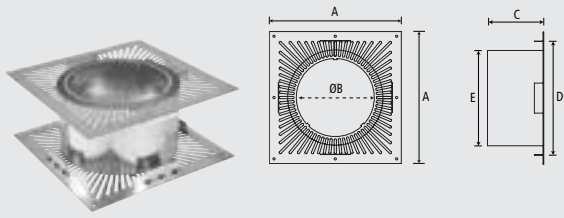

Floor & ceiling ventilated plate & shield

including Support Bracket

For use in internal applications where the upper section is enclosed. Designed to allow for the required 50mm clearance to combustibles. Includes support bracket, which can also act as a load bearing support for the system.

		A	ØB	C	D	E
Ø125mm	FXQ125-038S	327mm	179mm	150mm	277mm	231mm
Ø150mm	FXQ150-038S	352mm	204mm	150mm	302mm	256mm
Ø175mm	FXQ175-038S	377mm	229mm	150mm	327mm	281mm
Ø200mm	FXQ200-038S	402mm	254mm	150mm	352mm	306mm
Ø250mm	FXQ250-038S	452mm	304mm	150mm	402mm	356mm
Ø300mm	FXQ300-038S	502mm	354mm	150mm	452mm	406mm

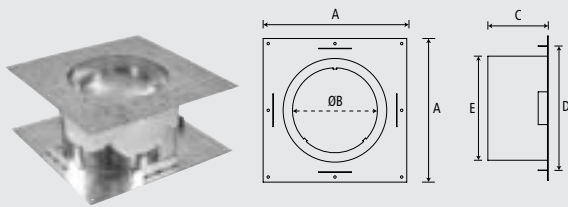

Floor & ceiling

non-ventilated plate & shield

including Support Bracket

For use in single storey buildings where the flue passes into a roof void. Designed to allow for the required 50mm clearance to combustibles. Includes support bracket, which can also act as a load bearing support for the system.

		A	ØB	C	D	E
Ø125mm	FXQ125-040S	327mm	179mm	150mm	277mm	231mm
Ø150mm	FXQ150-040S	352mm	204mm	150mm	302mm	256mm
Ø175mm	FXQ175-040S	377mm	229mm	150mm	327mm	281mm
Ø200mm	FXQ200-040S	402mm	254mm	150mm	352mm	306mm
Ø250mm	FXQ250-040S	452mm	304mm	150mm	402mm	356mm
Ø300mm	FXQ300-040S	502mm	354mm	150mm	452mm	406mm

FLUE ENCLOSURE



Flue enclosure including fixings

To meet building regulations, the flue system must be boxed in or properly enclosed in the loft. This is in order to avoid combustible materials falling against the outer skin of the flue or being placed too close to it.

		A	ØB
FXQ-080S	125 - 175mm I/D Flue pipe) Flue enclosure: comprises two halves and nine brackets.	1000mm	338mm
FXQ-080L	200 - 300mm I/D Flue pipe) Flue enclosure: comprises two halves and nine brackets.	1000mm	450mm

Decorative trim pieces

This 100mm decorative trim is designed to neaten installation holes in both walls and ceilings. They can be secured by sealing or by using the pre-drilled holes provided.

Two Piece

	0° Trim piece	30° Trim piece	45° Trim piece
Ø125mm	FXQ125-077	FXQ125-034	FXQ125-035
Ø150mm	FXQ150-077	FXQ150-034	FXQ150-035
Ø175mm	FXQ175-077	FXQ175-034	FXQ175-035
Ø200mm	FXQ200-077	FXQ200-034	FXQ200-035
Ø250mm	FXQ250-077	FXQ250-034	FXQ250-035
Ø300mm	FXQ300-077	FXQ300-034	FXQ300-035

One Piece

Ø125mm	FXQ125-077-1	FXQ125-034-1	FXQ125-035-1
Ø150mm	FXQ150-077-1	FXQ150-034-1	FXQ150-035-1
Ø175mm	FXQ175-077-1	FXQ175-034-1	FXQ175-035-1
Ø200mm	FXQ200-077-1	FXQ200-034-1	FXQ200-035-1
Ø250mm	FXQ250-077-1	FXQ250-034-1	FXQ250-035-1
Ø300mm	FXQ300-077-1	FXQ300-034-1	FXQ300-035-1

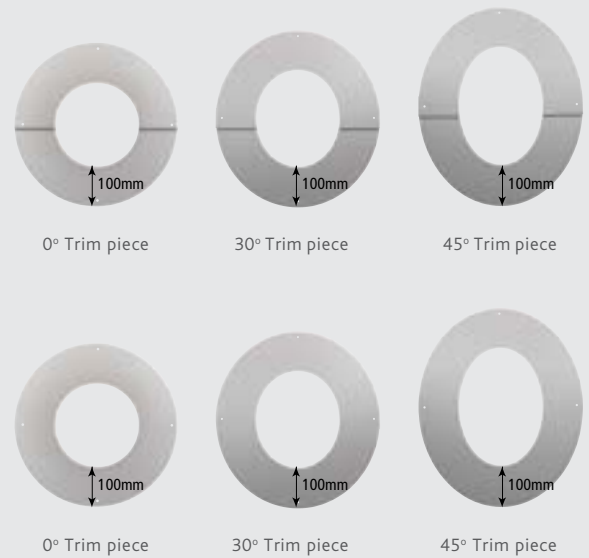

Adjustable ceiling/wall trim piece

This selection of adjustable stainless steel trim pieces are designed to ensure the best aesthetic finish of twin wall flue passing through a ceiling or wall. Available to suit a wide selection of angles.

	0° - 15° Adjustable trim piece	A		B		15° - 30° Adjustable trim piece	A		B	
Ø125mm	FXQ125-073	241mm	325mm	FXQ125-074	244mm	325mm				
Ø150mm	FXQ150-073	253mm	350mm	FXQ150-074	258mm	350mm				
Ø175mm	FXQ175-073	266mm	375mm	FXQ175-074	271mm	375mm				
Ø200mm	FXQ200-073	278mm	400mm	FXQ200-074	283mm	400mm				
Ø250mm	FXQ250-073	303mm	450mm	FXQ250-074	309mm	450mm				
Ø300mm	FXQ300-073	328mm	500mm	FXQ300-074	334mm	500mm				

	30° - 45° Adjustable trim piece	A		B		45° - 60° Adjustable trim piece	A		B	
Ø125mm	FXQ125-075	255mm	325mm	FXQ125-076	300mm	325mm				
Ø150mm	FXQ150-075	270mm	350mm	FXQ150-076	331mm	350mm				
Ø175mm	FXQ175-075	285mm	375mm	FXQ175-076	365mm	375mm				
Ø200mm	FXQ200-075	299mm	400mm	FXQ200-076	406mm	400mm				
Ø250mm	FXQ250-075	327mm	450mm	FXQ250-076	455mm	450mm				
Ø300mm	FXQ300-075	363mm	500mm	FXQ300-076	530mm	500mm				

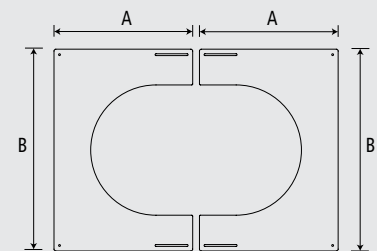
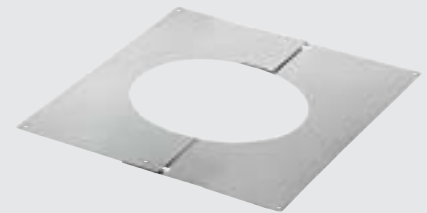

Decorative ceiling cover plate

This component is supplied powder coated white to give a perfect finish to the system when passing through a ceiling. Secured by eight supplied magnets, it is designed to fit over a ceiling firestop plate (see page 14), showing no visible fixings.

		A	ØB
Ø125mm	FXQ125-042WH	365mm	175mm
Ø150mm	FXQ150-042WH	390mm	200mm
Ø175mm	FXQ175-042WH	415mm	225mm
Ø200mm	FXQ200-042WH	440mm	250mm

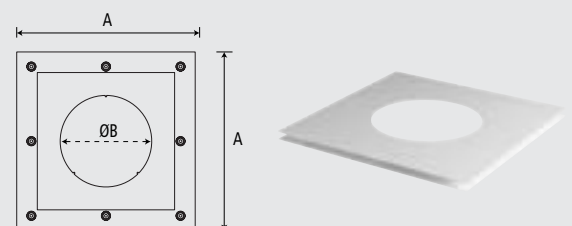

ALUMINIUM ROOF FLASHINGS

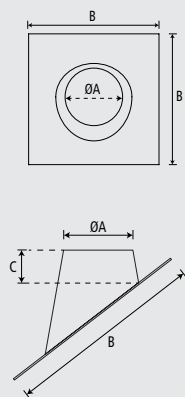
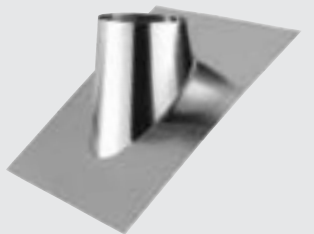
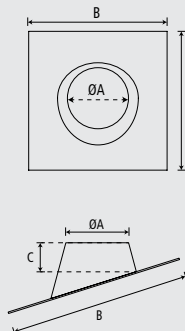
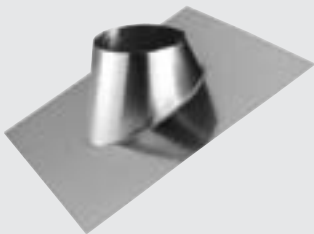
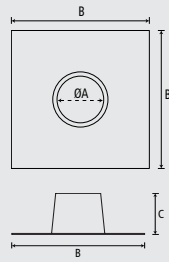

These products are used externally when the installation passes through a roof structure to provide a weatherproof seal to the surrounding weathered surface.

Flat Aluminium flashing

		ØA	B	C
Ø125mm	FXQ125-043	190mm	495mm	200mm
Ø150mm	FXQ150-043	210mm	495mm	200mm
Ø175mm	FXQ175-043	235mm	660mm	200mm
Ø200mm	FXQ200-043	260mm	660mm	200mm
Ø250mm	FXQ250-043	310mm	660mm	200mm
Ø300mm	FXQ300-043	360mm	660mm	200mm

5°-30° Aluminium flashing

		ØA	B	C
Ø125mm	FXQ125-044	190mm	495mm	100mm
Ø150mm	FXQ150-044	210mm	660mm	100mm
Ø175mm	FXQ175-044	235mm	660mm	100mm
Ø200mm	FXQ200-044	260mm	660mm	100mm
Ø250mm	FXQ250-044	310mm	660mm	100mm
Ø300mm	FXQ300-044	360mm	660mm	100mm

32°-45° Aluminium flashing

		ØA	B	C
Ø125mm	FXQ125-045	190mm	660mm	100mm
Ø150mm	FXQ150-045	210mm	660mm	100mm
Ø175mm	FXQ175-045	235mm	820mm	100mm
Ø200mm	FXQ200-045	260mm	820mm	100mm
Ø250mm	FXQ250-045	310mm	820mm	100mm
Ø300mm	FXQ300-045	360mm	820mm	100mm

LEAD ROOF FLASHINGS

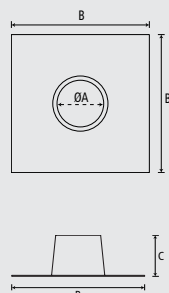

These products are used externally when the installation passes through a roof structure to provide a weatherproof seal to the surrounding weathered surface.

Flat Lead flashing

		ØA	B	C
Ø125mm	FXQ125-069	180mm	600mm	200mm
Ø150mm	FXQ150-069	210mm	600mm	200mm
Ø175mm	FXQ175-069	230mm	600mm	200mm
Ø200mm	FXQ200-069	260mm	600mm	200mm
Ø250mm	FXQ250-069	310mm	750mm	800mm
Ø300mm	FXQ300-069	360mm	800mm	800mm

These products are used externally when the installation passes through a roof structure to provide a weatherproof seal to the surrounding weathered surface.

10°-20° Lead flashing

		ØA	B	C
Ø125mm	FXQ125-079	180mm	600mm	600mm
Ø150mm	FXQ150-079	210mm	600mm	600mm
Ø175mm	FXQ175-079	230mm	600mm	600mm
Ø200mm	FXQ200-079	260mm	600mm	600mm
Ø250mm	FXQ250-079	310mm	750mm	800mm
Ø300mm	FXQ300-079	360mm	800mm	800mm

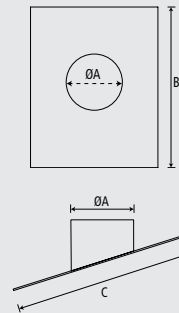

30°-40° Lead flashing

		ØA	B	C
Ø125mm	FXQ125-070	180mm	600mm	600mm
Ø150mm	FXQ150-070	210mm	600mm	600mm
Ø175mm	FXQ175-070	230mm	600mm	600mm
Ø200mm	FXQ200-070	260mm	600mm	600mm
Ø250mm	FXQ250-070	310mm	750mm	800mm
Ø300mm	FXQ300-070	360mm	800mm	800mm

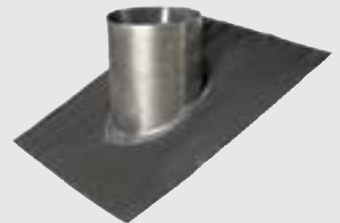
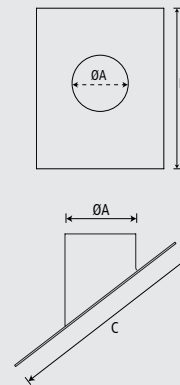

40°-50° Lead flashing

		ØA	B	C
Ø125mm	FXQ125-078	180mm	600mm	600mm
Ø150mm	FXQ150-078	210mm	600mm	600mm
Ø175mm	FXQ175-078	230mm	600mm	600mm
Ø200mm	FXQ200-078	260mm	650mm	650mm
Ø250mm	FXQ250-078	310mm	800mm	800mm
Ø300mm	FXQ300-078	355mm	800mm	750mm

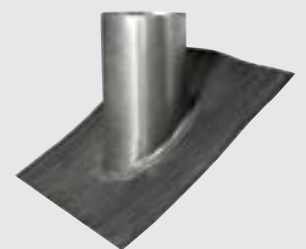
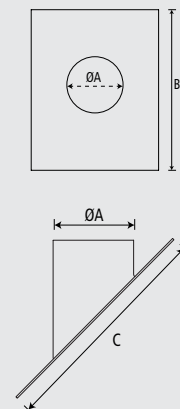

30°-40° Ridge flashing

		ØA	B	C
Ø125mm	FXQ125-072	180mm	600mm	300mm
Ø150mm	FXQ150-072	210mm	600mm	300mm
Ø175mm	FXQ175-072	230mm	600mm	300mm
Ø200mm	FXQ200-072	250mm	600mm	300mm
Ø250mm	FXQ250-072	310mm	750mm	375mm
Ø300mm	FXQ300-072	360mm	750mm	375mm

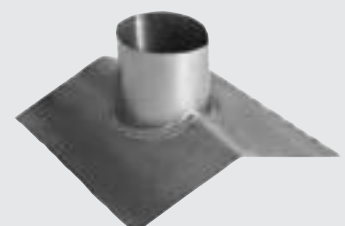
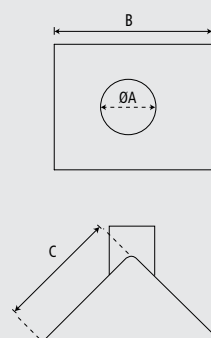

AQUASEAL ROOF FLASHINGS

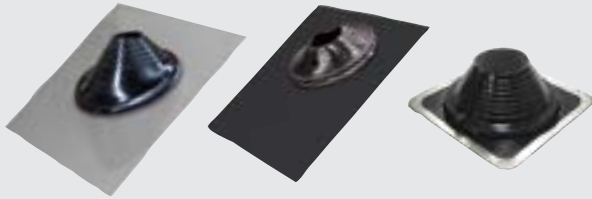

FXQ-052/053

FXQ-054

FXQ-058/059

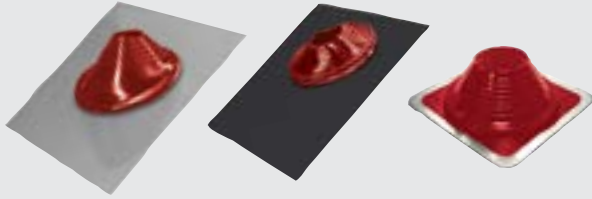

FXQ-052HT/053HT

FXQ-054HT

FXQ-058HT/059HT

Aquaseal Versatile Flashings

FXQ-052	125mm - 175mm Aluminium Base EPDM Black to 115°C (Base: 500mm x 600mm). 0-45 Degree
FXQ-053	150mm - 300mm Aluminium Base EPDM Black to 115°C (Base: 750mm x 900mm). 0-45 Degree
FXQ-054	125mm - 200mm Lead Base EPDM Black to 115°C (Base: 600mm x 850mm). 0-45 Degree
FXQ-058	200mm - 300mm Square Section EPDM Black to 115°C (Base: 440mm x 440mm). 0-45 Degree
FXQ-059	125mm - 200mm Square Section for metal and profiled roofs EPDM Black to 115°C (Base: 370mm x 370mm). 0-45 Degree
FXQ-059SK	EPDM Flashing Kit for FXQ-058, FXQ-059, FXQ-058HT & FXQ-059HT (Kit Contents: Silicone, Screws and Knife)
FXQ-052HT	125mm - 175mm Aluminium Base High Temperature Silicone to 240°C (Base: 500mm x 600mm). 0-45 Degree
FXQ-053HT	150mm - 300mm Aluminium Base High Temperature Silicone to 240°C (Base: 750mm X 900mm). 0-45 Degree
FXQ-054HT	125mm - 200mm Lead Base High Temperature Silicone to 240°C (Base: 600mm X 850mm)
FXQ-058HT	200mm - 300mm Square Section High Temperature Silicone to 240°C (Base: 440mm X 440mm). 0-45 Degree
FXQ-059HT	125mm - 200mm Square Section for metal and profiled roofs High Temperature Silicone to 240°C. (Base: 370mm X 370mm). 0-45 Degree

STORM COLLAR

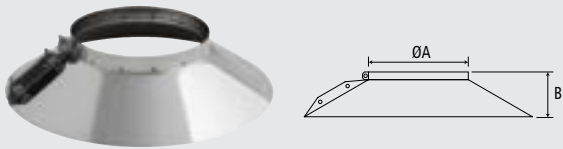

Storm collar

This component, incorporating captive nuts as standard, can be quickly and easily sealed securely to the flue pipe; minimising the risk of leakages and reducing installation time.

		ØA	B	C
Ø125mm	FXQ125-046R	175mm	80mm	350mm
Ø150mm	FXQ150-046R	200mm	80mm	370mm
Ø175mm	FXQ175-046R	225mm	80mm	400mm
Ø200mm	FXQ200-046R	250mm	80mm	425mm
Ø250mm	FXQ250-046R	300mm	80mm	485mm
Ø300mm	FXQ300-046R	350mm	80mm	535mm

CHIMNEY SAFETY DATA PLATE



The Chimney Safety Data Plate can be used to permanently record the flue registration and its technical specification thus complying with Building Regulations ADJ that any chimney or appliance installation must have a notice plate fixed in a visible position. Possible locations are within the fireplace or adjacent to the electricity meter, or next to the mains water stop valve.

FXQ-081	Chimney Safety Data Plate
---------	---------------------------

Cowls are fitted to the end of the flue pipe and secured using our Twist-Lock system to provide complete protection for the installation.

Open terminal

		ØA	ØB	C
Ø125mm	FXQ125-047	125mm	125mm	130mm
Ø150mm	FXQ150-047	150mm	150mm	130mm
Ø175mm	FXQ175-047	175mm	175mm	130mm
Ø200mm	FXQ200-047	200mm	200mm	130mm
Ø250mm	FXQ250-047	250mm	250mm	130mm
Ø300mm	FXQ300-047	300mm	300mm	130mm

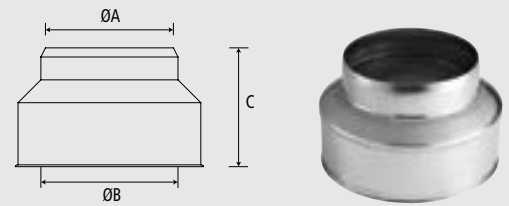

Rain cowl

		ØA	B
Ø125mm	FXQ125-048	125mm	250mm
Ø150mm	FXQ150-048	150mm	250mm
Ø175mm	FXQ175-048	175mm	250mm
Ø200mm	FXQ200-048	200mm	250mm
Ø250mm	FXQ250-048	250mm	250mm
Ø300mm	FXQ300-048	300mm	250mm

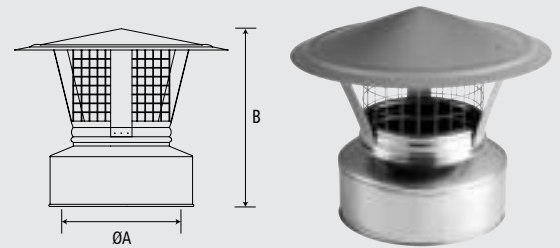

Weather/wind cowl

		ØA	B
Ø125mm	FXQ125-049	125mm	250mm
Ø150mm	FXQ150-049	150mm	250mm
Ø175mm	FXQ175-049	175mm	250mm
Ø200mm	FXQ200-049	200mm	250mm
Ø250mm	FXQ250-049	250mm	250mm
Ø300mm	FXQ300-049	300mm	250mm

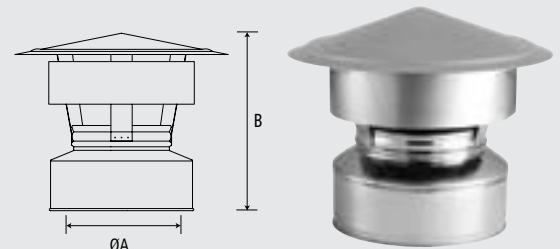

Anti-down draft cowl

complete with twist lock fitting

Designed in collaboration with Eurocowl specifically for Stovax's Professional XQ™ range.

		ØA	B
Ø125mm	FXQ125-050	125mm	280mm
Ø150mm	FXQ150-050	150mm	280mm
Ø175mm	FXQ175-050	175mm	280mm
Ø200mm	FXQ200-050	200mm	295mm

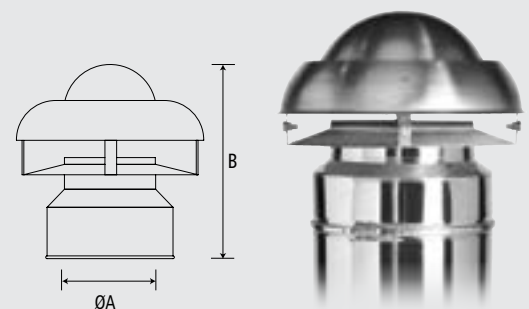

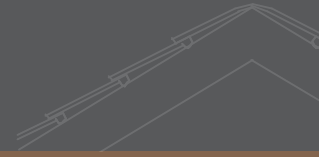

Straight without door

	Colour	306mm length	612mm length	918mm length	1130mm length
Ø125mm	Matt Black	4500	4501	4502	4545
Ø125mm	Ivory	4500IV	4501IV	4502IV	-
Ø150mm	Matt Black	4600	4601	4602	4645
Ø150mm	Ivory	4600IV	4601IV	4602IV	-
Ø175mm	Matt Black	4700	4701	4702	-
Ø200mm	Matt Black	4800	4801	4802	-

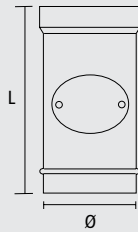

Straight with door

	Colour	306mm length	612mm length	918mm length
Ø125mm	Matt Black	4504	4505	4506
Ø125mm	Ivory	4504IV	4505IV	4506IV
Ø150mm	Matt Black	4604	4605	4606
Ø150mm	Ivory	4604IV	4605IV	4606IV
Ø175mm	Matt Black	4704	4705	4706
Ø200mm	Matt Black	4804	4805	4806

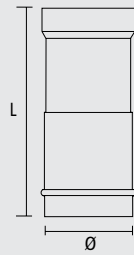

Telescopic straight without door

	Colour	380 - 635mm length	1015 - 1370mm length
Ø125mm	Matt Black	4542	4540
Ø150mm	Matt Black	4642	4640
Ø175mm	Matt Black	-	4740
Ø200mm	Matt Black	-	4840

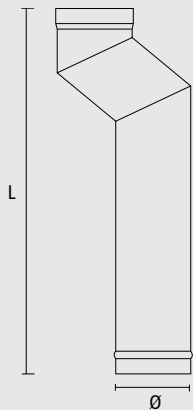

Offset straight without door

	Colour		L
Ø125mm	Matt Black	4541	600mm
Ø150mm	Matt Black	4641	600mm

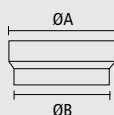

Cut length adaptor

	Colour		ØA	ØB
Ø125mm	Matt Black	4519	130mm	125mm
Ø150mm	Matt Black	4619	155mm	150mm
Ø175mm	Matt Black	4719	181mm	175mm
Ø200mm	Matt Black	4819	206mm	200mm

Bend with door

Colour	90°	A	L	110°	A	L
Ø125mm Matt Black	4514 †	171mm	225mm	4513	150mm	255mm
Ø150mm Matt Black	4614 †	184mm	245mm	4613	153mm	280mm
Ø175mm Matt Black	4714 †	200mm	280mm	4713	175mm	302mm
Ø200mm Matt Black	4814 †	223mm	325mm	4813	191mm	322mm

† Depending on location, restrictions may apply to the use of 90° bends. Please refer to local Building Regulations.

Colour	135°	A	L	150°	A	L
Ø125mm Matt Black	4512	130mm	295mm	4522	130mm	305mm
Ø150mm Matt Black	4612	136mm	325mm	-	-	-
Ø175mm Matt Black	4712	140mm	295mm	4622	136mm	315mm
Ø200mm Matt Black	4812	191mm	320mm	-	-	-
				4722	140mm	315mm
				4822	191mm	345mm

Bend without door

Colour	135°	A	L
Ø125mm Matt Black	4537	130mm	295mm
Ø125mm Ivory Enamel	4537IV	130mm	295mm
Ø150mm Matt Black	4637	136mm	325mm
Ø150mm Ivory Enamel	4637IV	136mm	325mm
Ø175mm Matt Black	4737	140mm	295mm
Ø200mm Matt Black	4837	180mm	310mm

Colour	150°	A	L
Ø125mm Matt Black	4538	130mm	305mm
Ø150mm Matt Black	4638	136mm	315mm
Ø175mm Matt Black	4738	170mm	320mm
Ø200mm Matt Black	4838	180mm	345mm

Increasing adaptor

Colour	ØA	ØB	L	
Ø100mm - Ø125mm Matt Black	4418	102mm	127mm	255mm
Ø125mm - Ø150mm Matt Black	4518	127mm	152mm	255mm
Ø150mm - Ø175mm Matt Black	4618	152mm	178mm	255mm
Ø175mm - Ø200mm Matt Black	4718	178mm	203mm	255mm

90° Gas quick bend elbow

Colour	A	L	
Ø125mm Matt Black	4521	109mm	178mm

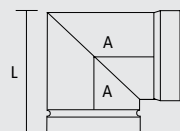
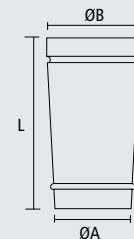
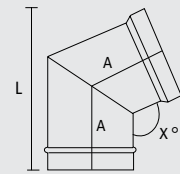
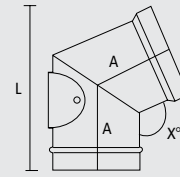

ENAMELLED FLUE PIPE

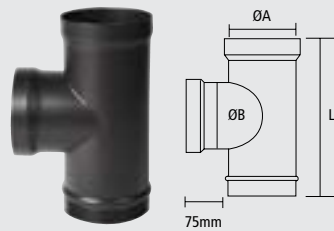
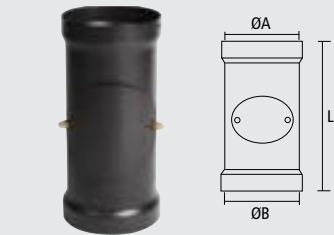
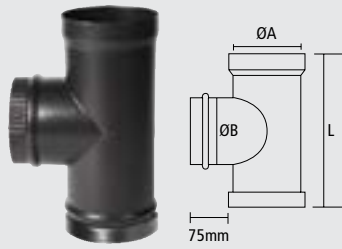

Tee piece with end cap

	Colour	90°	ØA	ØB	L
Ø125mm	Matt Black	4516	127mm	127mm	305mm
Ø125mm	Ivory Enamel	4516IV	127mm	127mm	305mm
Ø150mm	Matt Black	4616	152mm	152mm	305mm
Ø150mm	Ivory Enamel	4616IV	152mm	152mm	305mm
Ø175mm	Matt Black	4716	178mm	178mm	357mm
Ø200mm	Matt Black	4816	203mm	203mm	380mm

Double socket straight

	Colour		ØA	ØB	L
305mm Straight with door	Matt Black	4508	130mm	130mm	306mm
610mm Straight with door	Matt Black	4509	130mm	130mm	612mm
915mm Straight with door	Matt Black	4510	130mm	130mm	918mm

Double socket Tee piece with end cap

	Colour		ØA	ØB	L
90° Tee with end cap	Matt Black	4517	130mm	130mm	306mm
90° Tee with end cap	Matt Black	4617	153mm	153mm	306mm

ACCESSORIES



Flue dampers

	Ø
3068	100mm
3060	125mm
3061	150mm
3062	175mm
3063	200mm

Flue collars

	Ø
2038	125mm
2039	150mm
2040	175mm
2041	200mm

Magnetic flue pipe thermometer

3046	Magnetic flue pipe thermometer
------	--------------------------------

ACCESSORIES

Stovax also offers a wide range of cleaning & maintenance products. For details of our full accessories range, please contact your Stovax retailer or visit www.stovax.com or scan the code to view or download our brochure.



Professional XQ™ touch-up paint

	Colour		Size	Quantity
Touch-up paint	Matt Black (BK)	FXQ-PAINT-400	400ml	x1
Touch-up paint	Satin Black (SB)	FXQ-PAINTSB-400	400ml	x1

Thermolac stove paint

	Colour		Size	Quantity
Thermolac - brush-on paint	Matt Black	2057-6	200ml	x6
Thermolac - stove spray paint	Metallic Black	2000-1	400ml	x1
Thermolac - stove spray paint	Matt Black	2019	400ml	x12
Thermolac - stove spray paint	Matt Black	2019-6	400ml	x6
Thermolac - stove spray paint	Matt Black	2010	400ml	x1
Thermolac - stove spray paint	Metallic Blue	2019BL	400ml	x6
Thermolac - stove spray paint	Metallic Brown	2019BR	400ml	x6
Thermolac - stove spray paint	Metallic Green	2019GR	400ml	x6
Thermolac - stove spray paint	Matt Ivory	2055	150ml	X1
Thermolac - stove spray paint	Metallic Black	2056-6	400ml	x6
Thermolac - stove spray paint	Metallic Black	RVAC011	150ml	x1
Thermolac - stove spray paint	Storm Metallic	RVAC010	150ml	x1

Before ordering stove paint please consult the Stovax Accessories brochure for full product suitability.



Fire cement

		Size	Quantity
Fire cement tub (Black. Fire resistant up to 1250°C)	2024	5kg	x1
Fire cement tubs	2020	500g	x12
Fire cement tubs	2020-6	500g	x6
Fire cement cartridges	2021	600g	x12
Fire cement cartridges	2021-6	600g	x6



Chimney rods and brushes

Rods and Adaptors		Length
Uni rod (Needs adaptor 4034 & must always be rotated clockwise to avoid disconnection)	4036	915mm
Lockfast rod (Needs adaptor 4035 & can be rotated in either direction)	4037	915mm
Uni Adaptor	4034	-
Lockfast Adaptor	4035	-
Brush heads	Steel	Polypropylene
125mm Brush head	4171	4030
150mm Brush head	4172	4031
175mm Brush head	4173	4032
200mm Brush head	4174	4033
305mm Brush head	-	4039
405mm Brush head	-	4038

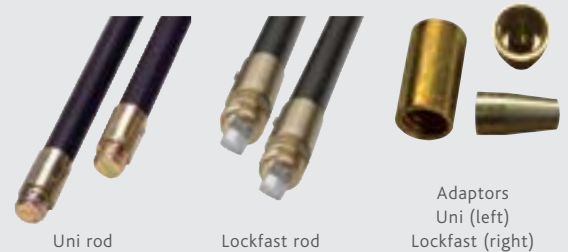

Uni rod

Lockfast rod

Adaptors
Uni (left)
Lockfast (right)



Steel brush head



Polypropylene brush head

Carbon monoxide detector

Easy to install & no maintenance required. Battery pre-fitted & guaranteed for 6 years.

Carbon monoxide detector	3045
--------------------------	------



Carbon monoxide detector

KEY TECHNICAL BENEFITS

Stovax is at the forefront of design and technological advancement within the heating industry, and the innovative Professional XQ™ range is testament to our commitment to constant improvement and development. With a host of expertly designed key features, you can trust Stovax to provide your complete fireplace and chimney solution.

Key Technical Benefits

- **Weather Proof and Fully Sealed Components**

With fully sealed components, the Stovax Professional XQ™ System can be installed in all weather conditions. Unlike some other systems, the inner insulation is protected by formed stainless steel. This will also protect the installer from the risk of abrasions or cuts from sharp flue edges.

- **Easy to Install Twist-Lock System**

All Stovax Professional XQ™ components incorporate a Twist-Lock system designed to allow an easy and rapid installation of your chimney system. When used with other Professional XQ™ support components, this joint will support up to 2m from the last support.

- **Locking Bands Included**

Unlike some other chimney systems, all Professional XQ™ components are supplied with an appropriate number of locking bands as standard.

- **Decorative Single to Twin Adaptor/Increaser**

This adaptor is a decorative component designed to improve the connection between single skin enamelled flue pipe and the Professional XQ™ Chimney System. The single skin enamelled flue pipe can be inserted into the adaptor by up to 90mm to give a completely seamless join. For total flexibility, Stovax offers the Decorative Increaser when you wish to connect 125mm single skin vitreous to a 150mm Stovax Professional XQ™ System.

- **Extended 135° Tee Piece**

The Extended 135° Tee features a 750mm tough-wall section which allows for a joint free connection. There is also a standard tee cap included for easy inspection and sweeping.

- **Ceiling Cover Plate**

The Ceiling Cover plate is an innovative component designed to eradicate the issue of unsightly ventilated fire plates. In an attractive powder coated white with invisible fixings, it can be used to cover the ventilated plate*, whilst still complying with the BSRIA standards for these components.

- **Base Socket/Spigot Plate**

With the extra support provided by the Professional XQ™ Twist-Lock System, the Base Socket/Spigot Plate can support up to 12m of Chimney System when combined with the Base Wall Support Plate and Brackets.

- **Roof Support**

Robust and secure, the Roof Support can support the weight of up to 9m of your flue system. This component stabilises your installation down to 6m below the support and up to 3m above it. However, if the system does extend more than 3m vertically you will require the lateral support of the Roof Bracing Kit.

- **Adjustable Flue Length**

To provide complete system versatility, each adjustable flue length offers you a variation of up to 360mm in height. Additional insulation is provided to fill the extra flue height created, and must be fitted in accordance with the installation instructions.

*Ventilated Plates are required when either passing through a combustible ceiling or floor void, or when a system is to be fully enclosed.



When you purchase a Stovax Professional XQ™ Chimney System from one of our approved independent retailers you are buying into a network of unsurpassed support and expertise. Not only can you be sure that you are getting the highest quality components and products, but you will also receive the highest level of customer care.

Dedicated Service & FlueDesigner™ App

- **Committed Customer Service**

As a member of our expert network, your Stovax retailer will be able to answer any questions you may have about your home heating and chimney requirements. Backed up by our own friendly Customer Service teams, you can get all the help you need in selecting the system that is right for you.

- **Dedicated Technical Support Team**

Our network of independent retailers and specifiers have access to our dedicated, HETAS registered Professional XQ™ Technical Support team. All of the team are expertly trained and on hand to offer comprehensive advice and practical telephone assistance both onsite and off.

- **Professional XQ™ 'FlueDesigner™' App**

To further simplify your installation, Stovax has created a bespoke app for iOS and Android mobile devices that will design your Professional XQ™ system, giving guidance on everything you need from your stove to the rain cow!*. Created for the exclusive use of our independent retailers and specifiers, this easy-to-use app will generate a guideline specification, including a diagrammatic drawing, bill of materials, component list and quotation all based upon the information you provide regarding the installation.



The Professional XQ™ FlueDesigner™ app is a handy, time saving tool for retailers and specifiers:

- Covers a variety of installation types including house, bungalow, barn conversion and vaulted ceiling properties
- Comprehensive, diagrammatic drawing of your installation
- List of components needed for your flue system
- Bill of Materials and quotation
- Instant online ordering
- Optimised for Android and iOS devices
- Desktop synchronisation
- FlueDesigner™ technical support

The FlueDesigner™ app joins a host of other benefits that have all been designed to make your chimney system specification and installation as simple as possible.

Our passionate approach to the quality design and complete reliability of all our products shines through in our innovative chimney systems range. Make the quality choice when it comes to your system selection, make it Stovax Professional XQ™.

* Please note that the Professional XQ™ FlueDesigner™ app should be used as a quotation and installation guide, and in no way should be deemed a substitute for a full site survey.

** Based on the input of accurate site survey measurements and requirements.

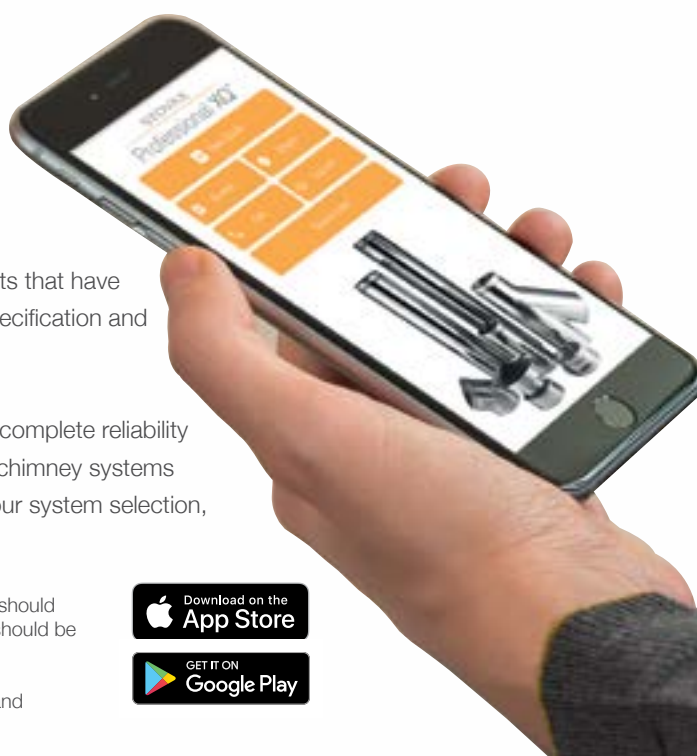

General installation instructions

You are advised to have your intended installation checked and surveyed by an appropriately qualified person. In the UK this would be a HETAS chimney specialist for solid fuel systems or GasSafe registered member for gas systems. They will also be able to complete your installation in accordance with the current local building regulations.

For further guidance on installation issues that are not already detailed within the Professional XQ™ Chimney Systems Installation Instructions, you can contact one of the following:

- HETAS (Heating Equipment Testing and Approval Scheme)
- NACS (National Association of Chimney Sweeps)
- Manufacturer's installation instructions for the heating appliance.

Further checks by your installer will be required to ensure that an adequate air supply is available for combustion and it is essential these checks are carried out prior to installation.

It is important that you have fully designed your system and read all the relevant instructions and local building regulations and taken expert advice before commencing installation.

In particular you will need to ensure the installer has checked all local regulations, including those referring to national and European standards, to ensure full compliance of your installation.



THROUGH WALL INSTALLATION

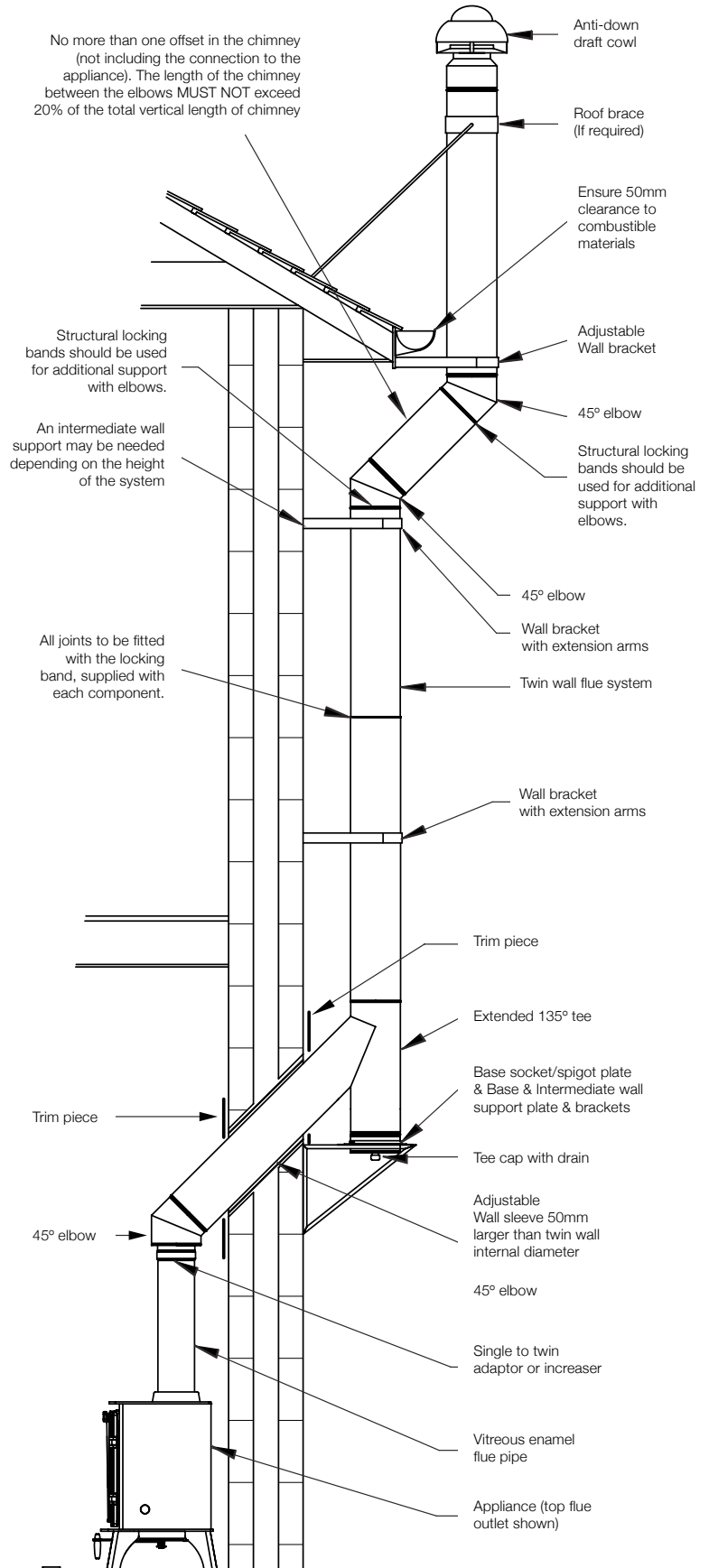

INTERNAL INSTALLATION WITH BUILDING ENCLOSURE

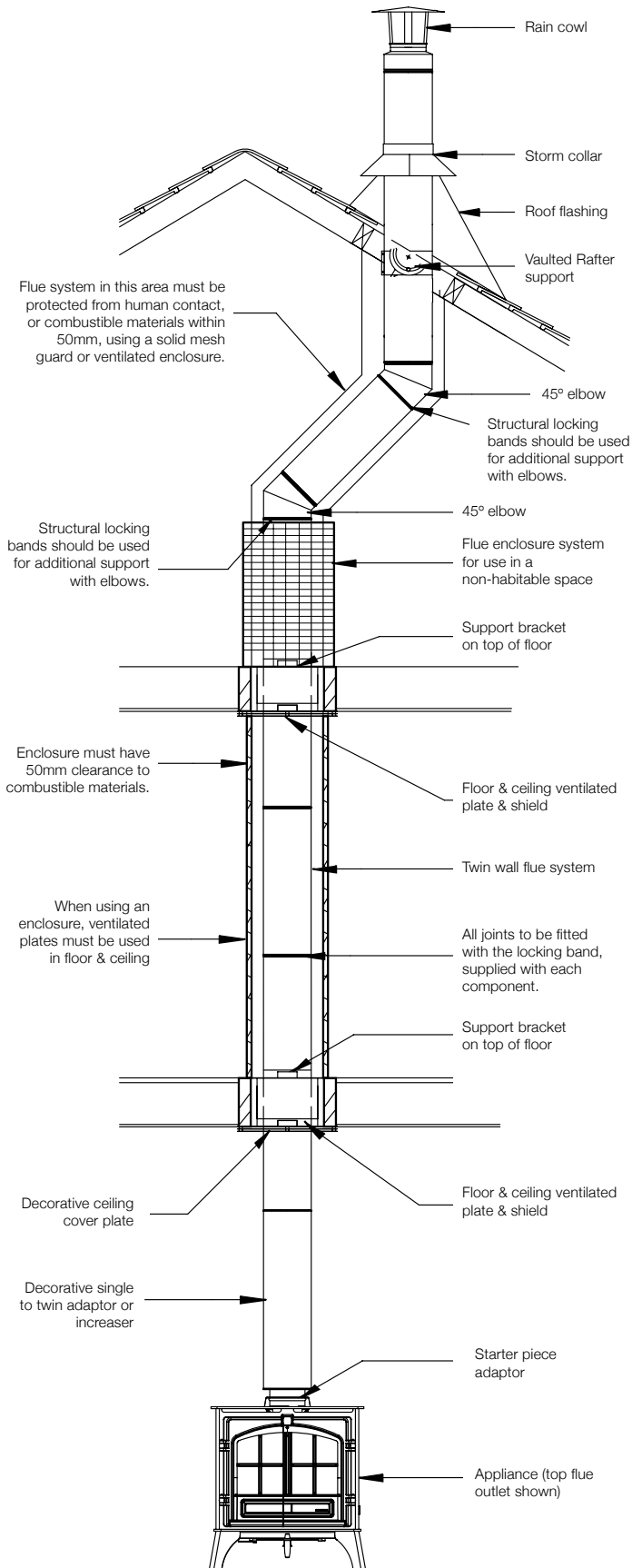

INTERNAL INSTALLATION FOR SINGLE STOREY BUILDING

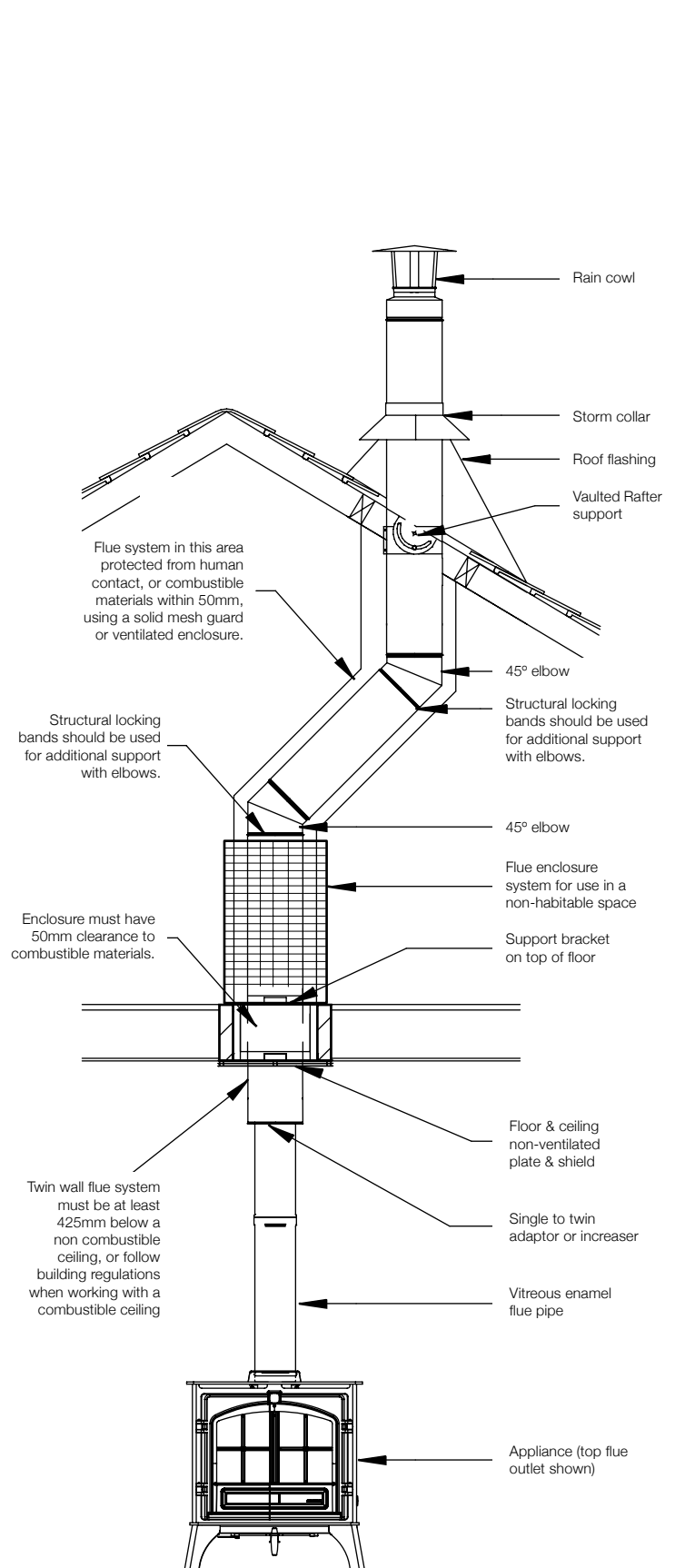

General installation instructions

Below is a summary of the General Installation Instructions. Please note that this is not a substitute for reading the full Stovax Professional XQ™ Chimney Systems Installation Instructions which can be downloaded from www.stovax.com/chimneysystems.

1. The minimum distance for the Stovax Professional XQ™ Chimney System to combustible materials is 50mm. Please ensure that this distance is maintained at all times.
2. In attic or loft spaces, use our flue enclosure (FXQ-080) to prevent any contact with combustible materials and ensure that no additional insulation materials are placed around the flue.
3. When designing your system you should consider the following:
 - The internal diameter of the flue system should not be less than the size specified by the appliance manufacturer.
 - The minimum recommended height for any solid fuel flue system should be 4.5m from the top of the appliance.
 - The roof terminal position must conform to building regulations.
 - No joint should occur within any floor, ceiling or wall space.
 - Where the system passes through a floor or ceiling space, shielding must be fitted to maintain clearances to combustible materials.

For example:

Through the wall (see page 12 for details)



Adjustable wall sleeve

Through the ceiling (see page 14 for details)

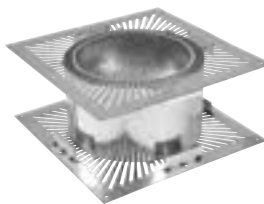

Floor & ceiling ventilated plate & shield

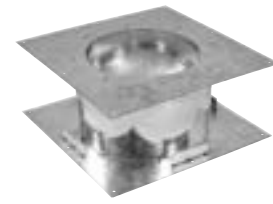

Floor & ceiling non-ventilated plate & shield

- The connection to the twin wall system should be in the same room as the appliance.
 - The system should be fully supported along its full length.
 - Provision should be made to inspect and clean the flue.
4. Each joint is secured by locating the female socket over the male socket and twisting until tight and secure. The included locking band should then be placed over the joint and fastened to secure the length. All lengths must be installed with the male socket pointing upwards.
 5. A chimney data plate must be attached, as detailed in Approved Document J of the UK Building Regulations.
 6. The finished system should be commissioned as detailed in the installation instructions, and any significant faults rectified before the system is used with a fitted appliance.
 7. The textured Matt Black powder finish is suitable for internal applications only. It has a rated heat resistance up to 500°C and can safely be used right down to the stove. RAL colours used on external applications are rated up to 200°C and are therefore not suitable for use near the stove.
 8. The points listed on this page are only a guide to the correct installation of the Stovax Professional XQ™ flue system. For full installation details refer to the relevant sections throughout our installation manual along with the requirements of the UK Building Regulations, and any local regulations and working practices that may apply. Please see legal requirements on page 30 for further details.

Before installation of this product, please read the Stovax Professional XQ™ Chimney Systems Installation Instructions fully and any relevant building regulations.

Elbow Offset Chart

Elbows may be used in pairs to provide an offset in the flue system to avoid cutting joists and clear other obstructions. All offsets should be supported from above and below with the appropriate support component. No more than ONE offset can be in the chimney (not including the connection to the appliance). The length of the chimney between the elbows MUST NOT exceed 20% of the total vertical length of the chimney.

The dimensions of various offset combinations are listed below that follows the diagram to the right.

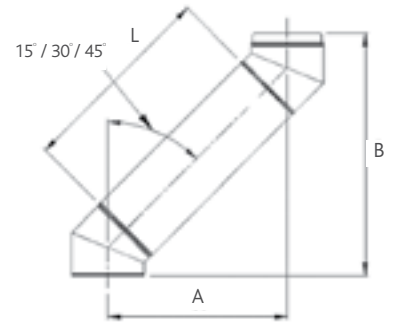

15° Offset Chart

Chimney Lengths (L)		125mm (Ø)		150mm (Ø)		175mm (Ø)		200mm (Ø)		250mm (Ø)		300mm (Ø)	
		A	B	A	B	A	B	A	B	A	B	A	B
None	None	37	279	37	284	38	290	41	299	41	310	43	324
5"	120mm	68	395	69	400	69	406	72	415	72	426	74	440
12"	300mm	114	569	115	574	116	580	164	589	118	599	120	614
20"	500mm	166	762	167	767	167	769	169	782	170	793	172	807
30"	750mm	231	1003	232	1008	232	1010	233	1023	235	1034	237	1048
39"	1000mm	295	1245	296	1250	296	1252	298	1265	300	1276	302	1290
48"	1200mm	347	1438	348	1444	348	1445	350	1458	351	1469	353	1483
12"+20"	300mm + 500mm	244	1052	245	1047	245	1059	246	1071	248	1082	250	1097
12"+39"	300mm + 1000mm	373	1535	374	1540	374	1542	376	1555	377	1565	379	1580
20"+39"	500mm + 1000mm	425	1728	426	1733	426	1735	428	1748	429	1759	431	1773
12"+20"+39"	300mm + 500mm + 1000mm	502	2018	503	2023	504	2024	505	2038	507	2048	509	2063

30° Offset Chart

Chimney Lengths (L)		125mm (Ø)		150mm (Ø)		175mm (Ø)		200mm (Ø)		250mm (Ø)		300mm (Ø)	
		A	B	A	B	A	B	A	B	A	B	A	B
None	None	79	295	83	309	86	322	89	332	96	359	103	383
5"	120mm	139	399	143	413	146	426	149	436	156	463	163	487
12"	300mm	229	555	233	568	236	582	239	592	246	619	253	643
20"	500mm	329	728	333	742	334	748	339	765	346	792	353	816
30"	750mm	454	945	458	958	459	965	464	982	471	1009	478	1033
39"	1000mm	579	1161	583	1175	584	1181	589	1198	595	1225	603	1249
48"	1200mm	679	1334	683	1348	684	1354	689	1371	696	1399	703	1422
12" + 20"	300mm + 500mm	479	988	483	1001	484	1008	489	1025	496	1052	503	1076
12" + 39"	300mm + 1000mm	729	1421	733	1434	734	1441	739	1458	746	1485	753	1509
20" + 39"	500mm + 1000mm	829	1594	833	1608	834	1614	839	1631	846	1658	853	1682
12" + 20" + 39"	300mm + 500mm + 1000mm	979	1854	983	1868	984	1874	989	1891	996	1918	1003	1942

45° Offset Chart

Chimney Lengths (L)		125mm (Ø)		150mm (Ø)		175mm (Ø)		200mm (Ø)		250mm (Ø)		300mm (Ø)	
		A	B	A	B	A	B	A	B	A	B	A	B
None	None	120	301	132	318	140	338	147	354	162	390	177	427
5"	120mm	210	386	216	403	225	423	232	439	247	475	262	512
12"	300mm	337	513	344	530	352	550	359	566	374	603	389	639
20"	500mm	478	655	485	671	493	691	500	708	515	744	530	780
30"	750mm	655	832	662	848	670	867	677	885	692	920	707	957
39"	1000mm	832	1008	839	1025	841	1045	854	1061	869	1098	884	1134
48"	1200mm	973	1150	980	1166	988	1186	995	1203	1010	1239	1025	1275
12" + 20"	300mm + 500mm	691	867	697	883	706	903	712	920	727	956	742	993
12" + 39"	300mm + 1000mm	1044	1221	1051	1237	1059	1257	1066	1273	1081	1310	1096	1346
20" + 39"	500mm + 1000mm	1185	1362	1192	1378	1201	1398	1207	1415	1222	1451	1237	1487
12" + 20" + 39"	300mm + 500mm + 1000mm	1398	1574	1404	1591	1413	1610	1419	1627	1435	1663	1450	1700

SITE REQUIREMENTS

Flue Outlet Positions

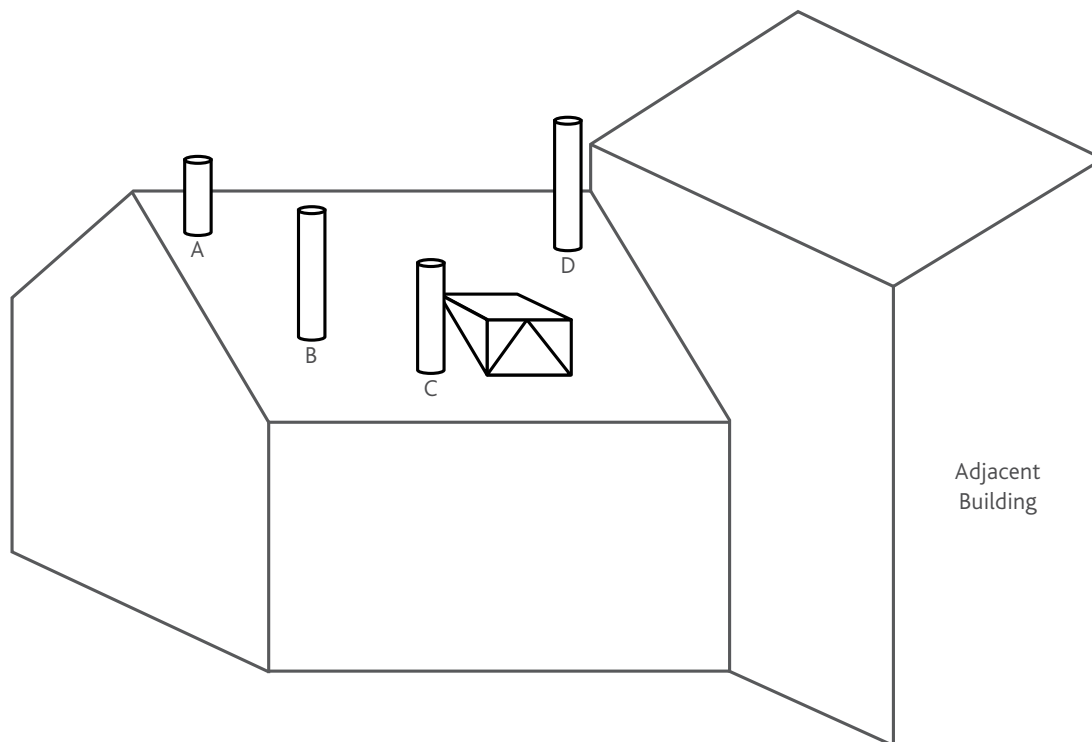

Point where the flue passes through weather surface (Notes 1 & 2)		Clearances to flue outlet
A	At or within 600mm of the ridge	At least 600mm above ridge
B	Elsewhere on roof (whether pitched or flat)	At least 2300mm horizontally from the nearest point on the weather surface and: a) at least 1000mm above highest point of intersection of the chimney and the weather surface; or b) at least as high as the ridge
C	Below (on a pitched roof) or within 2300mm horizontally to openable rooflight, dormer window, or other opening (Note 3)	At least 1000mm above the top of opening
D	Within 2300mm of an adjoining or adjacent building, whether or not beyond the boundary (Note 3)	At least 600mm above any part of the adjacent of building within 2300mm

1) The weather surface is the building external surface, such as it's roof tiles or external walls.

2) A flat roof has a pitch less than 10°.

3) The clearance given for A or B, as appropriate, will also apply.

4) A vertical flue fixed to an outside wall should be treated as equivalent to an inside flue emerging at the nearest edge of the roof.



Twist-Lock System

Each component in the Professional XQ™ range features our Twist-Lock system for complete ease of installation.

Simply locate the female socket over the male and twist until tight and secure. The included locking band should then be placed over the joint and fastened to secure the length. This easy-to-use system protects the installation against accidental uncoupling, giving complete peace of mind with your Professional XQ™ Chimney System.

IMPORTANT INFORMATION

Legal requirements for installation

All UK installations must conform to UK Building Regulations (England & Wales Document J/Scotland Part F/Northern Ireland Part L). For installations outside of the UK, you must check and conform to the relevant building regulations and national standards pursuant in that country.

All national building regulations and standards, along with any local regulations and working practices must be adhered to. Should any conflict occur between these instructions and the regulations then the regulations must take priority.

This brochure provides only basic guidance. The Stovax Professional XQ™ Chimney System should be installed by a competent person or approved by your local building officer. This brochure is not definitive and needs to be read and followed in conjunction with your local building regulations and other specific requirements and guidelines covering electrical, gas, solid fuel and multi-fuel appliances; as well as the full Stovax Professional XQ™ Chimney Systems Installation Instructions. When completing

the installation and building works, you should comply with your responsibilities under the Health & Safety at Work acts and any new regulations that may have been introduced during the lifetime of this brochure.

Particular attention should be drawn to:

- 1) **Handling** - The flue system may be heavy. Adequate facilities must be available for loading, unloading and handling.
- 2) **Asbestos** - This flue system contains no asbestos. If there is a possibility of disturbing any asbestos in the course of installation, please seek specialist guidance and use appropriate equipment.
- 3) **Metal Parts** - Take care when installing or servicing the flue to avoid personal injury.
- 4) **Access** - Ensure suitable and safe access is available when working at height and on roof areas.

A faulty installation can cause danger to the inhabitants and structure of the building.



Product Technical Specifications

The products are manufactured using:

- 0.5mm 316 grade stainless steel for the inner liners.
 - 0.5mm 304 grade stainless steel for the outer liners.
- (Both liners are fully seam welded and polished)

The cavity is insulated with 25mm ceramic mineral wool.

External diameter of adjustable flue pipe	
FXQ125	175mm
FXQ150	200mm
FXQ200	250mm
FXQ250	300mm
FXQ300	350mm

The textured Matt Black powder finish is suitable for internal applications only. It has a rated heat resistance up to 500°C and can safely be used right down to the stove. RAL colours used on external applications are rated up to 200°C and are therefore not suitable for use near the stove.

10 Year Extended Warranty

The Stovax Professional XQ™ range carries an extensive conditional warranty for complete peace of mind. The Stovax Professional XQ™ warranty covers any defect due to faulty manufacture provided that the system has been correctly specified, installed, used & maintained in accordance with the Installation and User Instructions. It includes a 10 Year Extended Warranty on twin wall components; 2 years on powder coated twin wall, single wall flue pipe and cowls and accessories as well as 1 year on lead flashings.

To maintain the warranty on your Chimney System, you must have your chimney system swept annually by an approved chimney sweep and a signed record of this needs to be maintained. In the case of solid fuel installations, your Stovax chimney system must only be used with fuels approved and specified by either HETAS or the Solid Fuel Association. Any other fuels will invalidate this warranty. Any chimney fire will also invalidate the warranty and it is always advisable to replace the system following a chimney fire.

To receive your Extended Warranty, your chimney system must have been purchased from an authorised retailer and registered with Stovax. For full details including other factors affecting the 10 Year Extended Warranty, please visit www.stovax.com/chimneysystems.





STOVAX

Fire Your Imagination

Stovax Limited, Falcon Road, Sowton Industrial Estate, Exeter, Devon, England, EX2 7LF

Chimney Systems Customer Services Tel: 01392 474040 **UK Trade sales Tel:** 01392 474000

Fax: 01392 219932 **Email:** chimneysystems@stovax.com

www.stovax.com www.stovax.com/chimneysystems



To view and download our complete range of brochures, simply scan this code or visit www.stovax.com/brochures

Paper sourced from sustainable forests and printed using vegetable based inks

PROXQ0319

© All material copyright Stovax Limited 2019 E & O E

A member of the Stovax Group

